

# ThinkSmart View Plus Hardware Maintenance Manual

Lenovo  
**ThinkSmart**



**Lenovo**

## **Read this first**

Before using this documentation and the product it supports, ensure that you read and understand the following:

- *Safety and Warranty Guide*
- *Generic Safety and Compliance Notices*

**First Edition (May 2023)**

**© Copyright Lenovo 2023.**

LIMITED AND RESTRICTED RIGHTS NOTICE: If data or software is delivered pursuant to a General Services Administration "GSA" contract, use, reproduction, or disclosure is subject to restrictions set forth in Contract No. GS-35F-05925.

---

# Contents

<b>About this manual</b> . . . . .	<b>.iii</b>	Remove the Wi-Fi thermal pad . . . . .	20
<b>Chapter 1. Product Overview</b> . . . . .	<b>1</b>	Remove the back cover. . . . .	20
Stylus Pen . . . . .	1	Remove the power lens. . . . .	21
Camera . . . . .	1	Remove the power button board . . . . .	22
Soundbar . . . . .	2	Remove the shielding bracket with cover . . . . .	23
Monitor and stand . . . . .	3	Remove the camera cable. . . . .	24
Statement on USB transfer rate . . . . .	5	Remove the power button cable . . . . .	25
<b>Chapter 2. General checkout</b> . . . . .	<b>7</b>	Remove the system board panel cable . . . . .	26
<b>Chapter 3. Hardware removal and installation</b> . . . . .	<b>9</b>	Remove the P sensor cable . . . . .	27
Service tool kit . . . . .	9	Remove the system board touch cable. . . . .	28
Major FRUs and CRUs . . . . .	10	Remove the Wi-Fi antennas . . . . .	29
Board connectors . . . . .	13	Remove the system board. . . . .	30
General Guidelines . . . . .	14	Remove the back bracket . . . . .	31
Remove the cable tie. . . . .	14	Remove the LVDS cable . . . . .	33
Remove the camera rubber . . . . .	14	Remove the bezel . . . . .	34
Remove the camera module . . . . .	15	Remove the panel . . . . .	34
Remove the Soundbar . . . . .	15	<b>Chapter 4. Help and support</b> . . . . .	<b>37</b>
Remove the Stylus Pen . . . . .	16	Help resources . . . . .	37
Remove the stand with base. . . . .	16	<b>Appendix A. Serial Number Location</b> . . . . .	<b>39</b>
Remove the heat sink . . . . .	18	<b>Appendix B. Notices and trademarks.</b> . . . . .	<b>41</b>
Remove the system board thermal pad . . . . .	19		



---

## About this manual

- This guide applies to Lenovo product model(s) listed below. Illustrations in this guide may look slightly different from your product model.
- This manual contains service and reference information for the following Lenovo products.

Model name	Machine type
ThinkSmart View Plus	12CN, 12CQ, 12CR, 12CS, 12CT, 12CU, 12CV, 12CW

- Use this manual along with the advanced diagnostic tests to troubleshoot problems.

**Important:** This manual is intended only for trained service technicians who are familiar with these products. Use this manual along with the advanced diagnostic tests to troubleshoot problems effectively. Before servicing one of these products, be sure to read and understand the important safety information in *Generic Safety and Compliance Notices*.



---

## Chapter 1. Product Overview

This chapter provides introductions to the connectors of ThinkSmart View Plus. For detailed technical specifications, go to Product Specifications Reference at: [psref.lenovo.com](https://psref.lenovo.com).

---

### Stylus Pen



---

### Camera

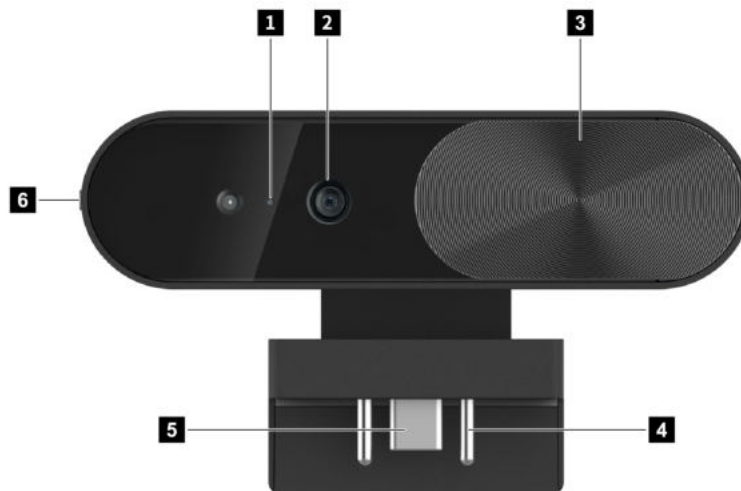

Description	Description
1. Camera LED	2. Camera lens
3. Privacy shutter	4. Guide pins
5. USB-C® (3.2 Gen 1) connector	6. Do not Disturb (DND) LED

## Soundbar

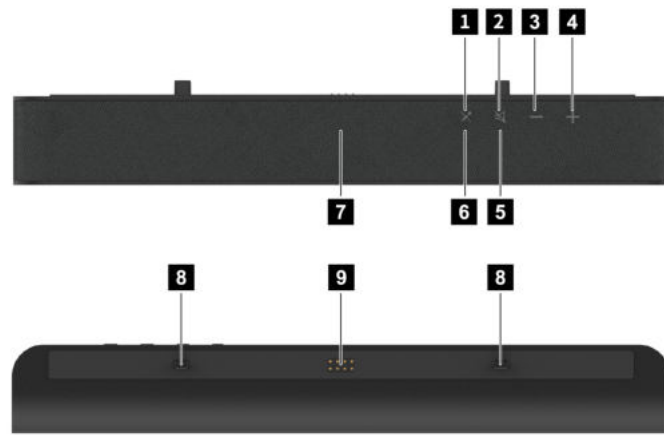

Description	Description
1. Microphone-mute button	2. Speaker-mute button
3. Volume-down button	4. Volume-up button
5. Speaker-mute LED	6. Microphone-mute LED
7. Microphone-status LED	8. Guide tabs
9. Pogo pins	



## Monitor and stand

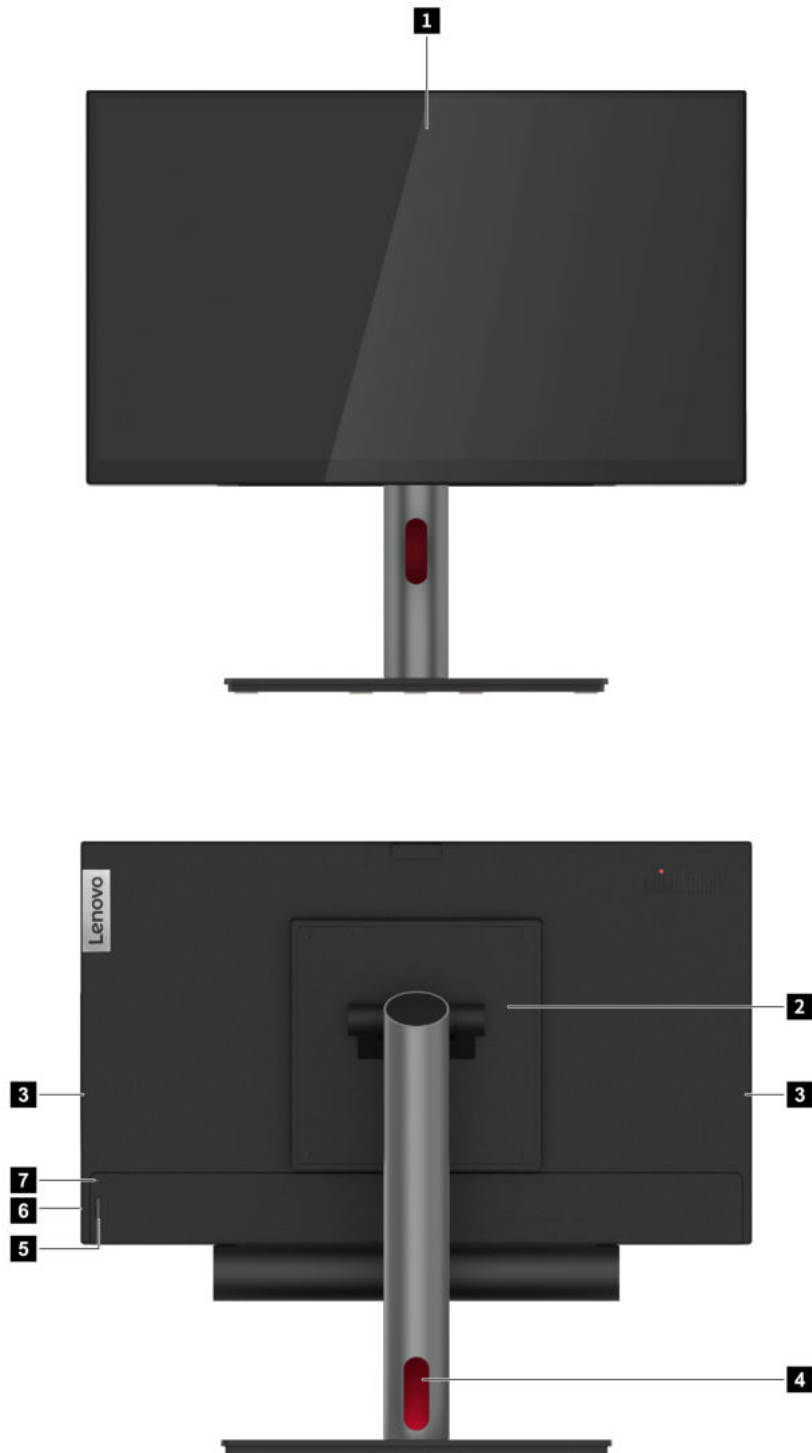

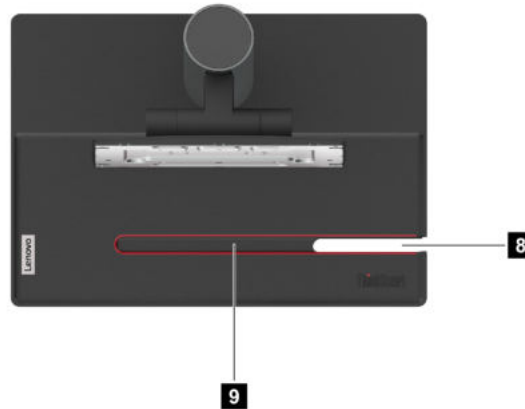

Description	Description
1. Touch screen	2. VESA mount plate
3. Pen storage areas	4. Cable hole
5. Power button	6. Power LED
7. Recovery button	8. Phone slot
9. Pen slot	

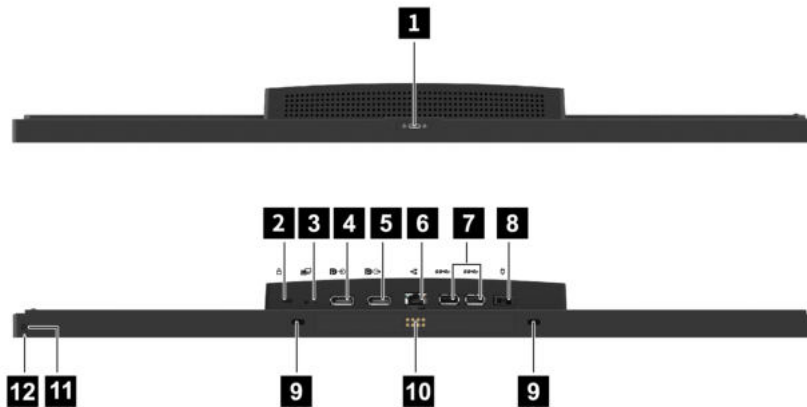

Description	Description
1. USB-C (3.2 Gen 1) connector and camera pin holes	2. Security-lock slot
3. USB-C (3.2 Gen 1) connector	4. DisplayPort™ in connector
5. DisplayPort out connector (works only when there is DisplayPort input from a computer)	6. Ethernet connector
7. USB-A (3.2 Gen 1) connectors	8. Power connector

<b>Description</b>	<b>Description</b>
9. Soundbar tab holes	10. Pogo pad
11. Mode-switch button	12. Mode-switch LED

## Statement on USB transfer rate

Depending on many factors such as the processing capability of the host and peripheral devices, file attributes, and other factors related to system configuration and operating environments, the actual transfer rate using the various USB connectors on this device will vary and will be slower than the data rate listed below for each corresponding device.

<b>USB device</b>	<b>Data rate (Gbit/s)</b>
3.2 Gen 1	5



---

## Chapter 2. General checkout

Before you go to the checkout guide, be sure to read the following important notes.

### Important notes:

- **Only certified trained personnel should service the product.**
- **Before replacing any FRU, read the entire page on removing and replacing FRUs.**
- **When you replace FRUs, it is recommended to use new nylon-coated screws.**
- **Be extremely careful during such write operations as copying, saving, or formatting.** Drives in the product that you are servicing sequence might have been altered. If you select an incorrect drive, data or programs might be overwritten.
- **Replace a FRU only with another FRU of the correct model.** When you replace a FRU, ensure that the model of the machine and the FRU part number are correct.
- **A FRU should not be replaced because of a single, unreproducible failure.** Single failures can occur for a variety of reasons that have nothing to do with a hardware defect, such as cosmic radiation, ESD, or software errors. Consider replacing a FRU only when a problem recurs. If you suspect that a FRU is defective, clear the error log and run the test again. If the error does not recur, do not replace the FRU.
- **Be careful not to replace a nondefective FRU.**

### What to do first

When you return a FRU, you must include the following information in the parts exchange form or parts return form that you attach to it:

1. Name and phone number of service technician
2. Date of service
3. Date on which the machine failed
4. Date of purchase
5. Failure symptoms, error codes appearing on the display, and beep symptoms
6. Procedure index and page number in which the failing FRU was detected
7. Failing FRU name and part number
8. Machine type, model number, and serial number
9. Customer's name and address

**Note:** During the warranty period, the customer may be responsible for repair costs if the product damage was caused by misuse, accident, modification, unsuitable physical or operating environment, or improper maintenance by the customer. Following is a list of some common items that are not covered under warranty and some symptoms that might indicate that the system was subject to stress beyond normal use.

Before checking problems with the product, determine whether the damage is covered under the warranty by referring to the following list:

### The following are not covered under warranty:

- Display cracked from the application of excessive force or from being dropped
- Scratched (cosmetic) component
- Distortion, deformation, or discoloration of the cosmetic component
- Plastic parts, latches, pins, or connectors that have been cracked or broken by excessive force
- Damage caused by liquid spilled into the system
- Damage caused by the improper insertion of a PC Card or the installation of an incompatible card
- Forgotten product password (making the product unusable)
- Use of an incorrect ac power adapter on laptop products

**The following symptoms might indicate damage caused by non-warranted activities:**

- Missing parts might be a symptom of unauthorized service or modification.
- Check for obvious damage to a hard disk drive. If the spindle of a hard disk drive becomes noisy, the hard disk drive might have been dropped or subject to excessive force.

---

## Chapter 3. Hardware removal and installation

This chapter provides instructions on how to remove and install hardware for your product. Video tutorials on hardware removal and installation are available at <https://support.lenovo.com/solutions/ht505031>.

---

### Service tool kit

Ensure that the following common service tool kit is prepared before you service the device.

No.	Tool name	Specific	Product scope	Tool type
1	Screw driver: Philips Head 0	PH0	All	Common tool
2	Screw driver: Philips Head 00	PH00	All	Common tool
3	Screw driver: Philips Head 01	1	All	Common tool
4	Screw driver: Philips Head 01	1, Shank length greater than 6 inches	ThinkSation/DT	Common tool
5	Screw driver: Philips Head 02	2, Shank length greater than 6 inches	ThinkSation/SC/DT	Common tool
6	Screw driver: Torx Head T5	T5	IdeaPad	Common tool
7	Screw driver: Torx Head T15	T15, for Chassis outside	ThinkSation	Common tool
8	Screw driver: Torx Head T20	T20, Shank length greater than 6 inches, for heatsink and CPU	ThinkSation	Common tool
9	Screw driver: Torx Head T30	T30, Shank length greater than 6 inches, for heatsink and CPU	ThinkSation	Common tool
10	Pry tools 1	N/A	All	Common tool
11	Tweezers (conductive)	N/A	All	Common tool
12	Tweezers (isolated)	N/A	All	Common tool
13	Suction cup	N/A	All	Common tool
14	Hexagonal socket (for VGA )	H5 mm or 4.8 mm	ThinkCentre/Tiny	Common tool
15	Hexagonal socket (for Tiny antenna)	H8 mm	ThinkCentre/Tiny	Common tool
16	Silicone grease for CPU or heatsink repairing	N/A	All	Consumable
17	Polyamide tape	N/A	All	Consumable
18	Mylar tape	N/A	All	Consumable
19	Eraser	N/A	All	Consumable
20	Electrical tape	N/A	All	Consumable

No.	Tool name	Specific	Product scope	Tool type
21	Double sided tape	N/A	All	Consumable
22	Conductive tape	N/A	All	Consumable
23	Cleaning pads/wipes	N/A	All	Consumable
24	Heat gun	N/A	All	Special tool
25	Brown brush	25 mm to 35 mm wide	All	Special tool

**Note:** The silicone grease can be applied to the surfaces of the microprocessor and heat sink to eliminate air gaps. The hexagonal socket is used to pick up the antenna connectors.

---

## Major FRUs and CRUs

Your product contains the following types of CRUs and FRUs:

- **Self-service CRUs:** Refer to parts that can be installed or replaced easily by customer themselves or by trained service technicians at an additional cost.
- **Optional-service CRUs:** Refer to parts that can be installed or replaced by customers with a greater skill level. Trained service technicians can also provide service to install or replace the parts under the type of warranty designated for the customer's machine.
- **FRUs:** Refer to parts that must be installed or replaced only by trained service technicians. If customers choose to replace the FRUs by themselves, the product warranty might be affected.

For detailed FRU and CRU information, such as the FRU part numbers and supported models, go to:

<http://www.lenovo.com/serviceparts-lookup>



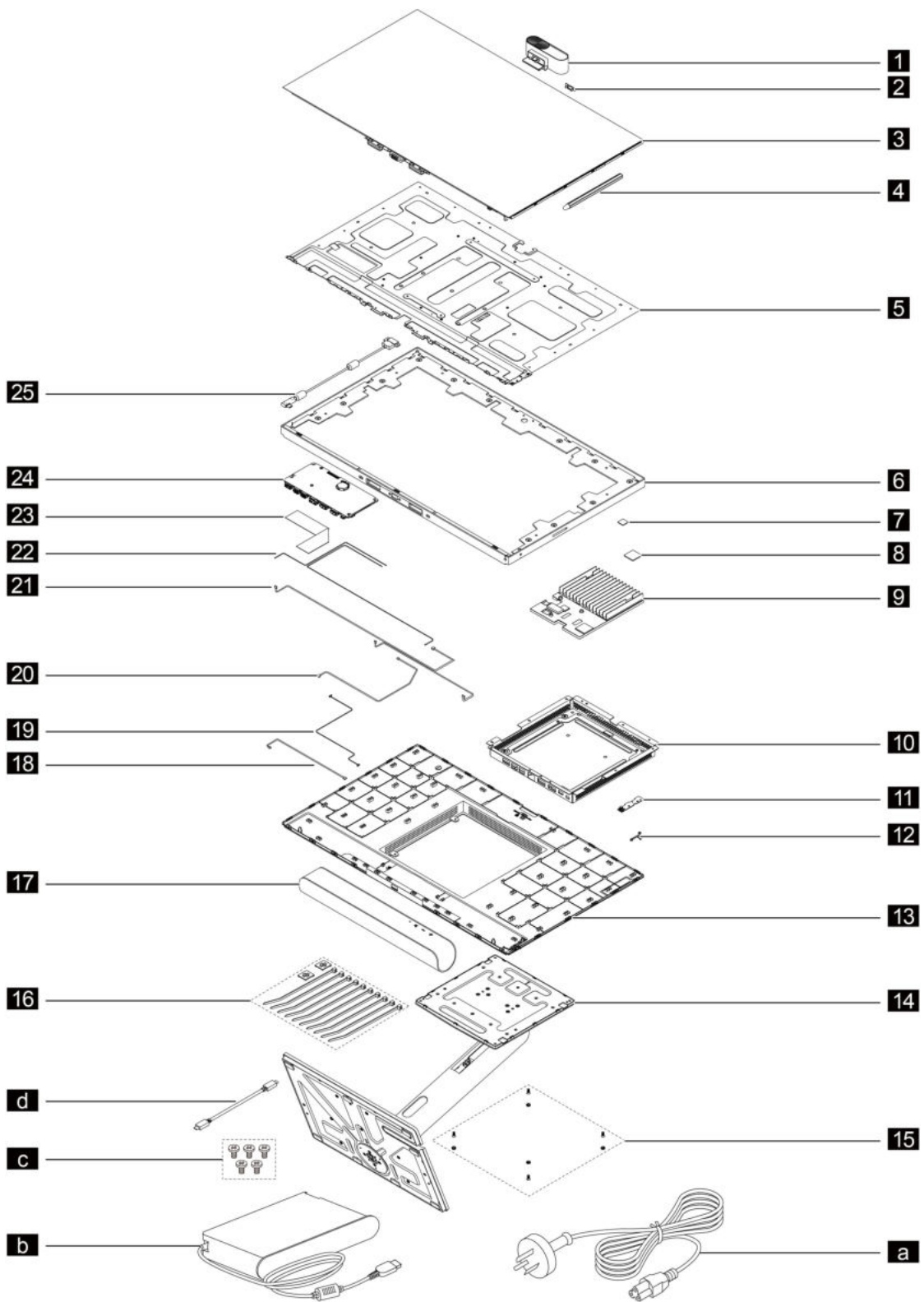

Number	Description	Self-service CRU	Optional-service CRU
<b>1</b>	Camera module	Yes	No
<b>2</b>	Camera rubber	Yes	No

<b>Number</b>	<b>Description</b>	<b>Self-service CRU</b>	<b>Optional-service CRU</b>
<b>3</b>	Panel	No	No
<b>4</b>	Stylus Pen	Yes	No
<b>5</b>	Back bracket	No	No
<b>6</b>	Bezel	No	No
<b>7</b>	System board thermal pad	No	No
<b>8</b>	Wi-Fi thermal pad	No	No
<b>9</b>	Heat sink	No	No
<b>10</b>	Shielding bracket with cover	No	No
<b>11</b>	Power button board	No	No
<b>12</b>	Power lens	No	No
<b>13</b>	Back cover	No	No
<b>14</b>	Stand with base	Yes	No
<b>15</b>	Stand screws with rubber	Yes	No
<b>16</b>	Cable hooks with ties	Yes	No
<b>17</b>	Soundbar	Yes	No
<b>18</b>	System board touch cable	No	No
<b>19</b>	Power button cable	No	No
<b>20</b>	System board panel cable	No	No
<b>21</b>	P sensor cable	No	No
<b>22</b>	Wi-Fi antennas	No	No
<b>23</b>	LVDS cable	No	No
<b>24</b>	System board	No	No
<b>25</b>	Camera cable	No	No
<b>a</b>	Power cord	Yes	No
<b>b</b>	AC power adapter	Yes	No
<b>c</b>	Screw kits	Yes	No
<b>d</b>	USB-C cable	Yes	No

## Board connectors

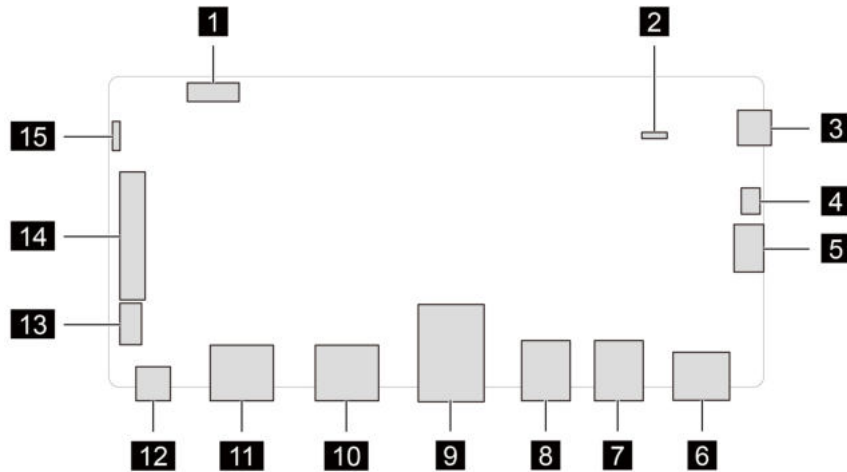

Figure 1. System board

Description	Description
<b>1</b> System board panel cable connector	<b>2</b> Wi-Fi antennas cable connector
<b>3</b> Camera cable connector	<b>4</b> System board touch cable connector
<b>5</b> Audio cable connector	<b>6</b> Power connector
<b>7</b> USB-A connector	<b>8</b> USB-A connector
<b>9</b> Ethernet connector	<b>10</b> DisplayPort out connector
<b>11</b> DisplayPort in connector	<b>12</b> USB-C connector
<b>13</b> P sensor cable connector	<b>14</b> LVDS cable connector
<b>15</b> Power button cable connector	

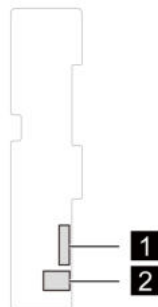

Figure 2. Power button board

Description	Description
<b>1</b> Power button cable connector	<b>2</b> LED FPC connector

---

## General Guidelines

When removing or replacing an FRU, ensure that you observe the following general guidelines:

1. Do not try to service any device unless you have been trained and certified. An untrained person runs the risk of damaging parts.
2. Begin by removing any FRUs that have to be removed before replacing the failing FRU. Any such FRUs are listed at the beginning of each FRU replacement procedure. Remove them in the order in which they are listed.
3. Follow the correct sequence in the steps for removing an FRU, as shown in the illustrations by the numbers in square callouts.
4. When removing an FRU, move it in the direction as shown by the arrow in the illustration.
5. To install a new FRU in place, perform the removal procedure in reverse and follow any notes that pertain to replacement.
6. When replacing an FRU, carefully retain and reuse all screws.
7. When replacing the base cover, reapply all labels that come with the replacement base cover. If some original labels are not included with the replacement base cover, peel them off from the original base cover and paste them on the replacement base cover.

**Attention:** The system board is sensitive to and can be damaged by ESD. Before touching it, establish personal grounding by touching a ground point with one hand or by using an ESD strap.

---

## Remove the cable tie

For access, do the following:

1. Place the device on a flat surface.

### Removal step

Remove the cable tie if any.



---

## Remove the camera rubber

For access, do the following:

1. Place the device on a flat surface.

### Removal step

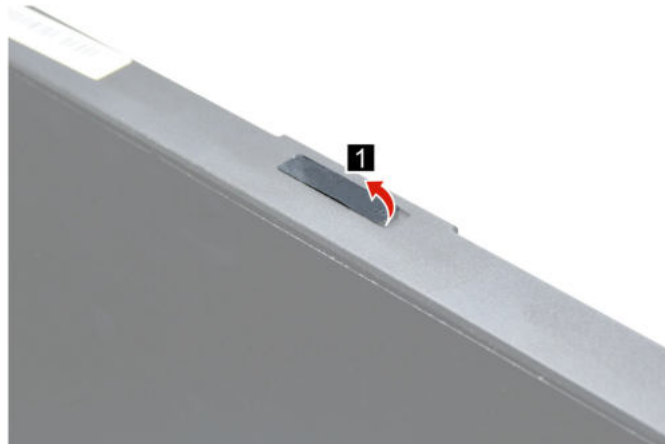

---

## Remove the camera module

For access, do the following:

1. Place the device on a flat surface.

### Removal step



---

## Remove the Soundbar

For access, do the following:

1. Place the device on a flat surface.

## Removal step



---

## Remove the Stylus Pen

For access, do the following:

1. Place the device on a flat surface.

## Removal step



---

## Remove the stand with base

### Prerequisite

Turn off ThinkSmart View Plus and wait several minutes until it is cool.

For access, do the following:

1. Remove the cable tie. See “Remove the cable tie” on page 14.
2. Remove the camera module. See “Remove the camera module” on page 15.

3. Remove the Soundbar. See “Remove the Soundbar” on page 15.
4. Remove the Stylus Pen. See “Remove the Stylus Pen” on page 16.
5. Disconnect the power cord from electrical outlet and disconnect all the cables from the device.
6. Place a clean soft cloth, and then lay down the device with the back cover facing up.

### Removal steps

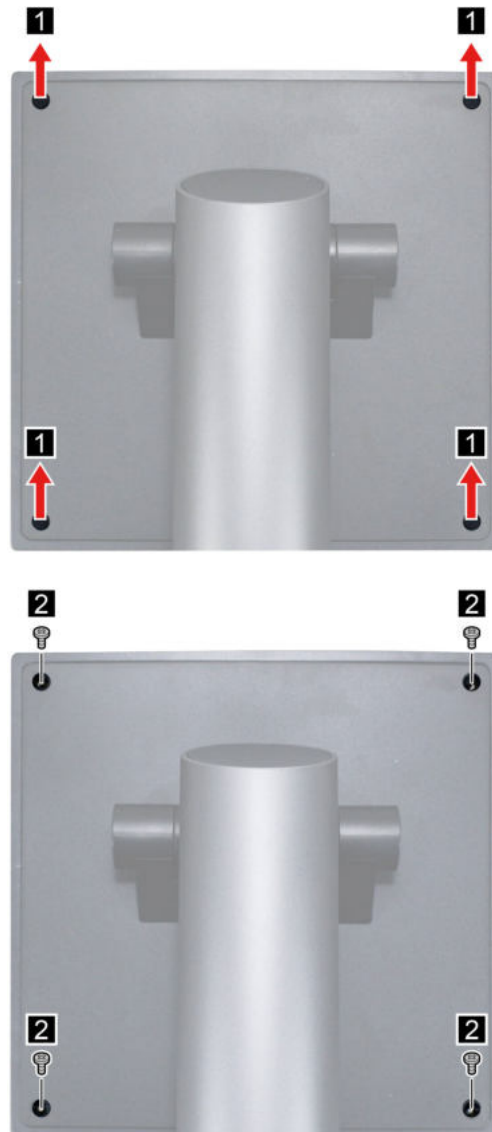

**Attention:** Use the screws provided by Lenovo to avoid any unpredictable damage to your device.

Step	Screw (quantity)	Color	Torque
2	M4 × 9.2 mm, flat-head (4)	Black	0.35±0.05 Nm (3.5±0.5 kgf-cm)

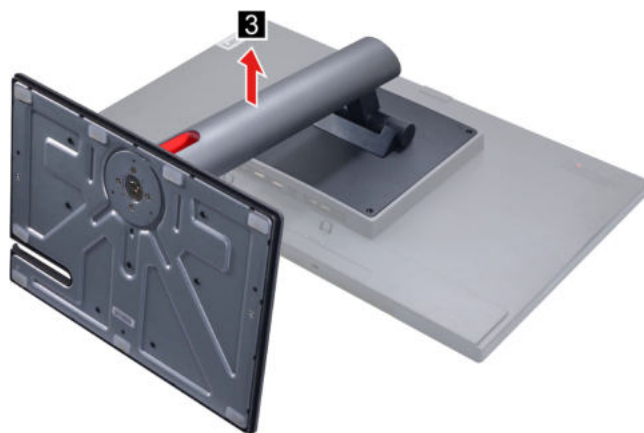

## Remove the heat sink

### Prerequisite

Turn off ThinkSmart View Plus and wait several minutes until it is cool.

For access, do the following:

1. Remove the cable tie. See “Remove the cable tie” on page 14.
2. Remove the camera module. See “Remove the camera module” on page 15.
3. Remove the Soundbar. See “Remove the Soundbar” on page 15.
4. Remove the Stylus Pen. See “Remove the Stylus Pen” on page 16.
5. Disconnect the power cord from electrical outlet and disconnect all the cables from the device.
6. Place a clean soft cloth, and then lay down the device with the back cover facing up.
7. Remove the stand with base. See “Remove the stand with base” on page 16.

### Removal steps

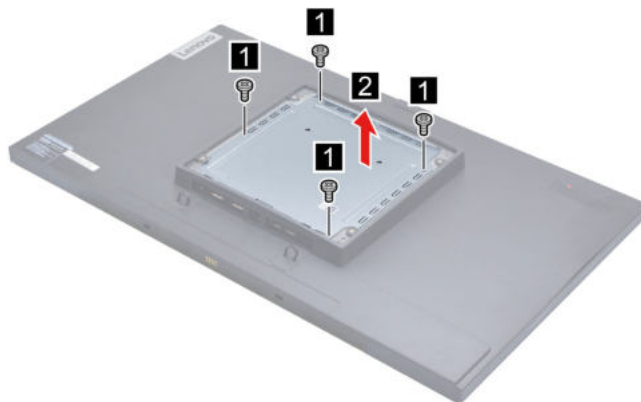

**Attention:** Use the screws provided by Lenovo to avoid any unpredictable damage to your device.

Step	Screw (quantity)	Color	Torque
<b>1</b>	M3 × 4.5 mm, flat-head (4)	Silver	0.18±0.05 Nm (1.8±0.5 kgf-cm)



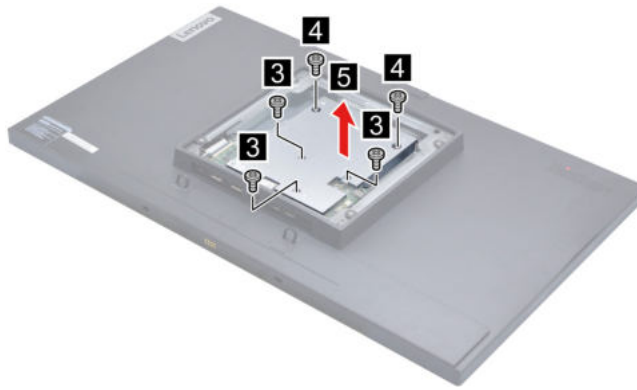

**Attention:** Use the screws provided by Lenovo to avoid any unpredictable damage to your device.

Step	Screw (quantity)	Color	Torque
<b>3</b>	M3 × 8 mm, flat-head (3)	Silver	0.18±0.05 Nm (1.8±0.5 kgf-cm)
<b>4</b>	M3 × 3.5 mm, flat-head (2)	Black	0.18±0.05 Nm (1.8±0.5 kgf-cm)

## Remove the system board thermal pad

### Prerequisite

Turn off ThinkSmart View Plus and wait several minutes until it is cool.

For access, do the following:

1. Remove the cable tie. See “Remove the cable tie” on page 14.
2. Remove the camera module. See “Remove the camera module” on page 15.
3. Remove the Soundbar. See “Remove the Soundbar” on page 15.
4. Remove the Stylus Pen. See “Remove the Stylus Pen” on page 16.
5. Disconnect the power cord from electrical outlet and disconnect all the cables from the device.
6. Place a clean soft cloth, and then lay down the device with the back cover facing up.
7. Remove the stand with base. See “Remove the stand with base” on page 16.
8. Remove the heat sink. See “Remove the heat sink” on page 18.

### Removal step

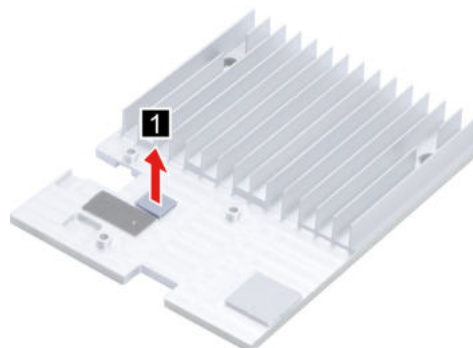

---

## Remove the Wi-Fi thermal pad

### Prerequisite

Turn off ThinkSmart View Plus and wait several minutes until it is cool.

For access, do the following:

1. Remove the cable tie. See “Remove the cable tie” on page 14.
2. Remove the camera module. See “Remove the camera module” on page 15.
3. Remove the Soundbar. See “Remove the Soundbar” on page 15.
4. Remove the Stylus Pen. See “Remove the Stylus Pen” on page 16.
5. Disconnect the power cord from electrical outlet and disconnect all the cables from the device.
6. Place a clean soft cloth, and then lay down the device with the back cover facing up.
7. Remove the stand with base. See “Remove the stand with base” on page 16.
8. Remove the heat sink. See “Remove the heat sink” on page 18.

### Removal step

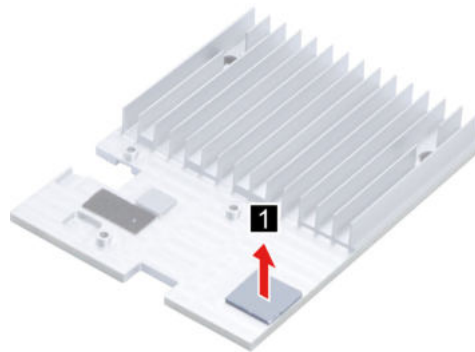

---

## Remove the back cover

### Prerequisite

Turn off ThinkSmart View Plus and wait several minutes until it is cool.

For access, do the following:

1. Remove the cable tie. See “Remove the cable tie” on page 14.
2. Remove the camera module. See “Remove the camera module” on page 15.
3. Remove the Soundbar. See “Remove the Soundbar” on page 15.
4. Remove the Stylus Pen. See “Remove the Stylus Pen” on page 16.
5. Disconnect the power cord from electrical outlet and disconnect all the cables from the device.
6. Place a clean soft cloth, and then lay down the device with the back cover facing up.
7. Remove the stand with base. See “Remove the stand with base” on page 16.

## Removal step

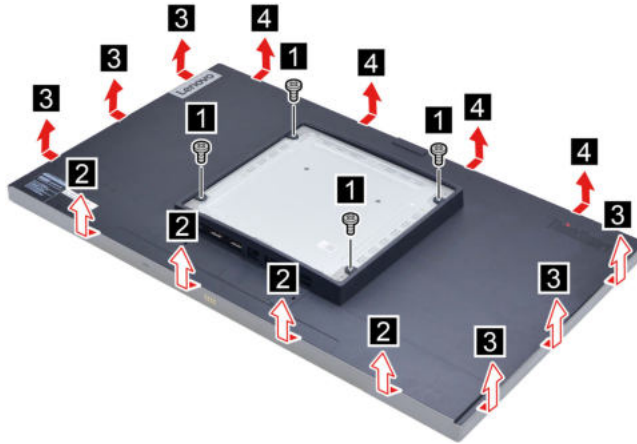

**Attention:** Use the screws provided by Lenovo to avoid any unpredictable damage to your device.

Step	Screw (quantity)	Color	Torque
<b>1</b>	M3 × 4.5 mm, flat-head (4)	Silver	0.18±0.05 Nm (1.8±0.5 kgf-cm)

## Remove the power lens

### Prerequisite

Turn off ThinkSmart View Plus and wait several minutes until it is cool.

For access, do the following:

1. Remove the cable tie. See “Remove the cable tie” on page 14.
2. Remove the camera module. See “Remove the camera module” on page 15.
3. Remove the Soundbar. See “Remove the Soundbar” on page 15.
4. Remove the Stylus Pen. See “Remove the Stylus Pen” on page 16.
5. Disconnect the power cord from electrical outlet and disconnect all the cables from the device.
6. Place a clean soft cloth, and then lay down the device with the back cover facing up.
7. Remove the stand with base. See “Remove the stand with base” on page 16.
8. Remove the back cover. See “Remove the back cover” on page 20.

## Removal step

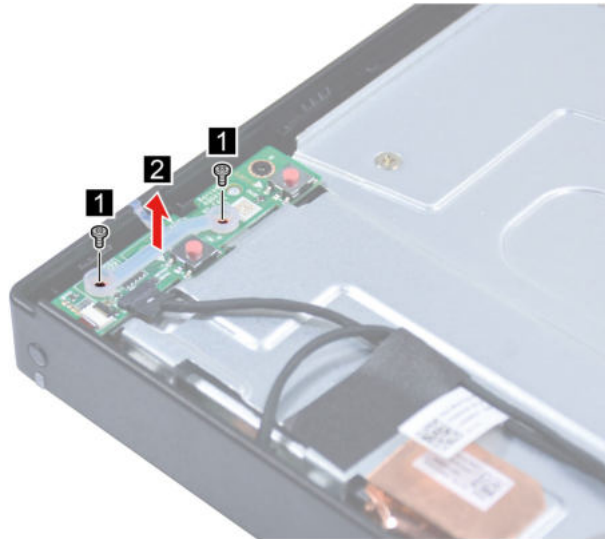

**Attention:** Use the screws provided by Lenovo to avoid any unpredictable damage to your device.

Step	Screw (quantity)	Color	Torque
<b>1</b>	M2 × 4.5 mm, flat-head (2)	Black	0.18±0.05 Nm (1.8±0.5 kgf-cm)

## Remove the power button board

### Prerequisite

Turn off ThinkSmart View Plus and wait several minutes until it is cool.

For access, do the following:

1. Remove the cable tie. See “Remove the cable tie” on page 14.
2. Remove the camera module. See “Remove the camera module” on page 15.
3. Remove the Soundbar. See “Remove the Soundbar” on page 15.
4. Remove the Stylus Pen. See “Remove the Stylus Pen” on page 16.
5. Disconnect the power cord from electrical outlet and disconnect all the cables from the device.
6. Place a clean soft cloth, and then lay down the device with the back cover facing up.
7. Remove the stand with base. See “Remove the stand with base” on page 16.
8. Remove the back cover. See “Remove the back cover” on page 20.
9. Remove the power lens. See “Remove the power lens” on page 21.

## Removal step

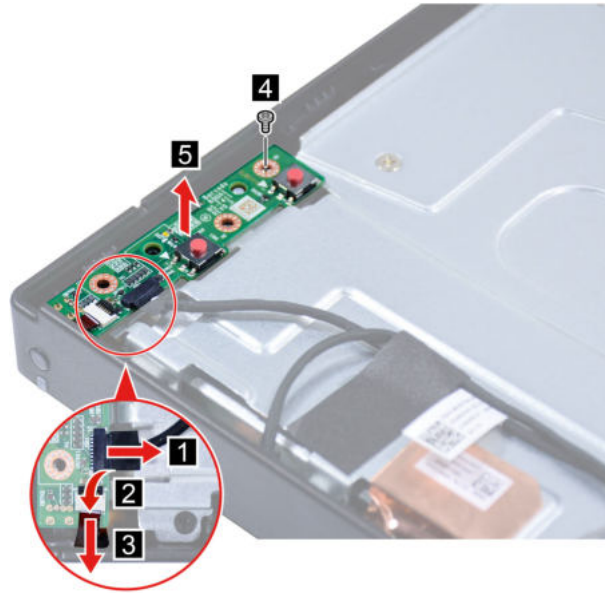

**Attention:** Use the screws provided by Lenovo to avoid any unpredictable damage to your device.

Step	Screw (quantity)	Color	Torque
4	M2 × 4.5 mm, flat-head (1)	Black	0.18±0.05 Nm (1.8±0.5 kgf-cm)

## Remove the shielding bracket with cover

### Prerequisite

Turn off ThinkSmart View Plus and wait several minutes until it is cool.

For access, do the following:

1. Remove the cable tie. See “Remove the cable tie” on page 14.
2. Remove the camera module. See “Remove the camera module” on page 15.
3. Remove the Soundbar. See “Remove the Soundbar” on page 15.
4. Remove the Stylus Pen. See “Remove the Stylus Pen” on page 16.
5. Disconnect the power cord from electrical outlet and disconnect all the cables from the device.
6. Place a clean soft cloth, and then lay down the device with the back cover facing up.
7. Remove the stand with base. See “Remove the stand with base” on page 16.
8. Remove the back cover. See “Remove the back cover” on page 20.

## Removal step

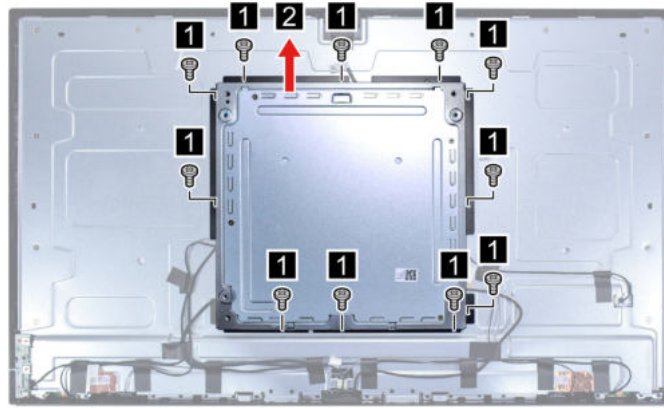

**Attention:** Use the screws provided by Lenovo to avoid any unpredictable damage to your device.

Step	Screw (quantity)	Color	Torque
<b>1</b>	M3 x 3.5 mm, flat-head (11)	Black	0.18±0.05 Nm (1.8±0.5 kgf-cm)

## Remove the camera cable

### Prerequisite

Turn off ThinkSmart View Plus and wait several minutes until it is cool.

For access, do the following:

1. Remove the cable tie. See “Remove the cable tie” on page 14.
2. Remove the camera module. See “Remove the camera module” on page 15.
3. Remove the Soundbar. See “Remove the Soundbar” on page 15.
4. Remove the Stylus Pen. See “Remove the Stylus Pen” on page 16.
5. Disconnect the power cord from electrical outlet and disconnect all the cables from the device.
6. Place a clean soft cloth, and then lay down the device with the back cover facing up.
7. Remove the stand with base. See “Remove the stand with base” on page 16.
8. Remove the back cover. See “Remove the back cover” on page 20.
9. Remove the shielding bracket with cover. See “Remove the shielding bracket with cover” on page 23.

## Removal steps

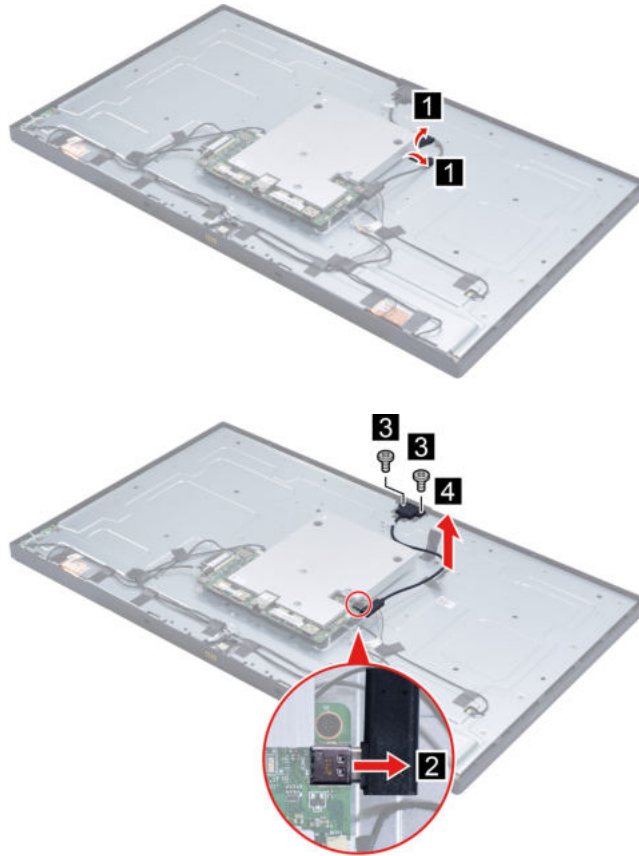

**Attention:** Use the screws provided by Lenovo to avoid any unpredictable damage to your device.

Step	Screw (quantity)	Color	Torque
3	M2 × 4.5 mm, flat-head (2)	Black	0.18±0.05 Nm (1.8±0.5 kgf-cm)

## Remove the power button cable

### Prerequisite

Turn off ThinkSmart View Plus and wait several minutes until it is cool.

For access, do the following:

1. Remove the cable tie. See “Remove the cable tie” on page 14.
2. Remove the camera module. See “Remove the camera module” on page 15.
3. Remove the Soundbar. See “Remove the Soundbar” on page 15.
4. Remove the Stylus Pen. See “Remove the Stylus Pen” on page 16.
5. Disconnect the power cord from electrical outlet and disconnect all the cables from the device.
6. Place a clean soft cloth, and then lay down the device with the back cover facing up.
7. Remove the stand with base. See “Remove the stand with base” on page 16.
8. Remove the back cover. See “Remove the back cover” on page 20.

9. Remove the shielding bracket with cover. See “Remove the shielding bracket with cover” on page 23.

### Removal steps

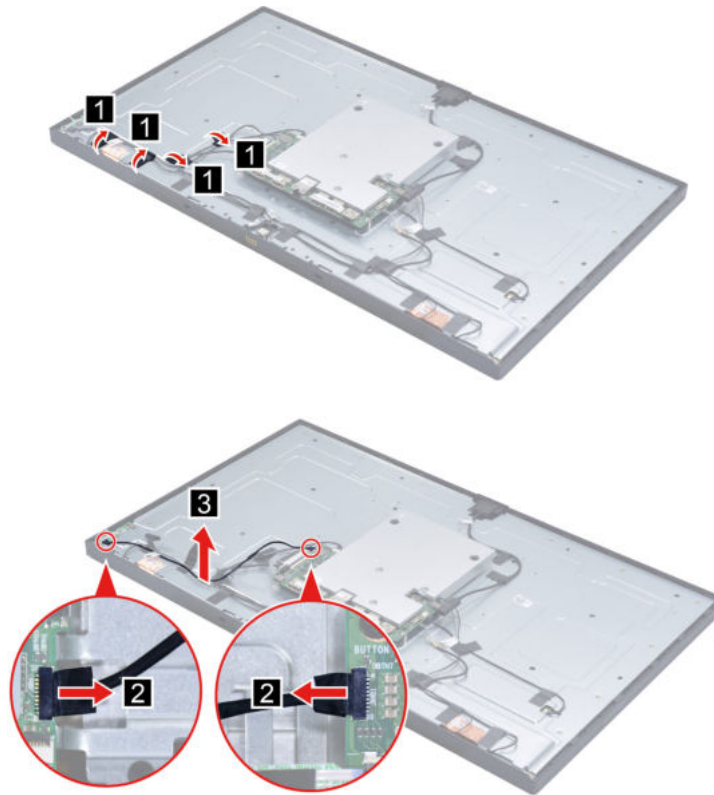

---

## Remove the system board panel cable

### Prerequisite

Turn off ThinkSmart View Plus and wait several minutes until it is cool.

For access, do the following:

1. Remove the cable tie. See “Remove the cable tie” on page 14.
2. Remove the camera module. See “Remove the camera module” on page 15.
3. Remove the Soundbar. See “Remove the Soundbar” on page 15.
4. Remove the Stylus Pen. See “Remove the Stylus Pen” on page 16.
5. Disconnect the power cord from electrical outlet and disconnect all the cables from the device.
6. Place a clean soft cloth, and then lay down the device with the back cover facing up.
7. Remove the stand with base. See “Remove the stand with base” on page 16.
8. Remove the back cover. See “Remove the back cover” on page 20.
9. Remove the shielding bracket with cover. See “Remove the shielding bracket with cover” on page 23.



## Removal steps

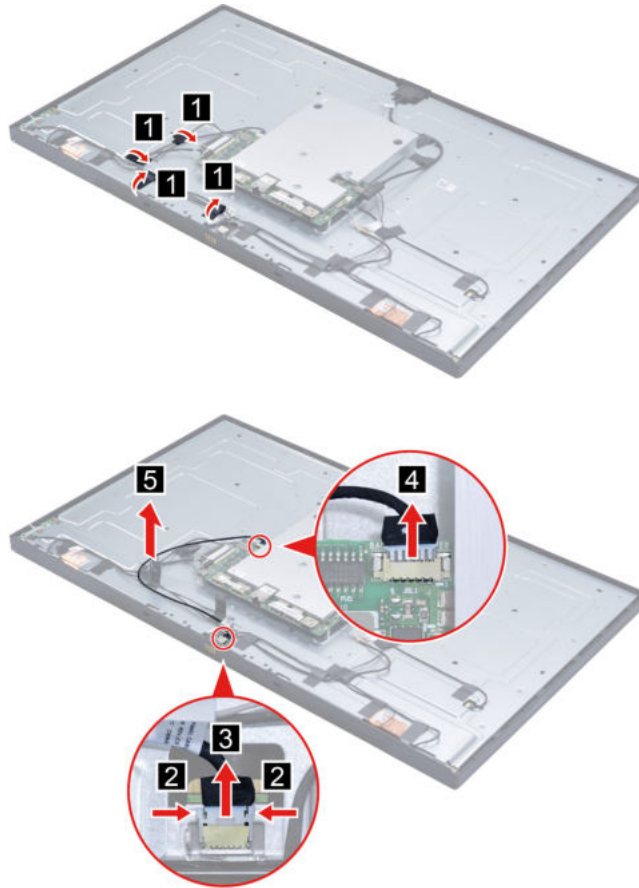

---

## Remove the P sensor cable

### Prerequisite

Turn off ThinkSmart View Plus and wait several minutes until it is cool.

For access, do the following:

1. Remove the cable tie. See “Remove the cable tie” on page 14.
2. Remove the camera module. See “Remove the camera module” on page 15.
3. Remove the Soundbar. See “Remove the Soundbar” on page 15.
4. Remove the Stylus Pen. See “Remove the Stylus Pen” on page 16.
5. Disconnect the power cord from electrical outlet and disconnect all the cables from the device.
6. Place a clean soft cloth, and then lay down the device with the back cover facing up.
7. Remove the stand with base. See “Remove the stand with base” on page 16.
8. Remove the back cover. See “Remove the back cover” on page 20.
9. Remove the shielding bracket with cover. See “Remove the shielding bracket with cover” on page 23.

## Removal steps

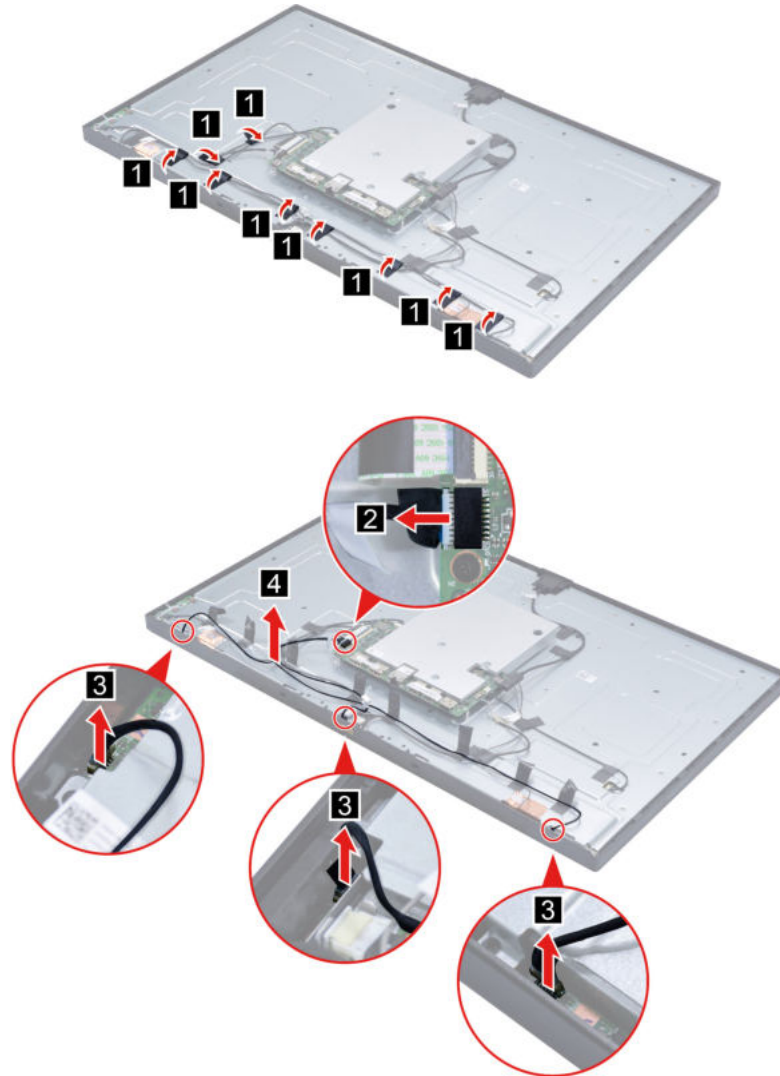

---

## Remove the system board touch cable

### Prerequisite

Turn off ThinkSmart View Plus and wait several minutes until it is cool.

For access, do the following:

1. Remove the cable tie. See “Remove the cable tie” on page 14.
2. Remove the camera module. See “Remove the camera module” on page 15.
3. Remove the Soundbar. See “Remove the Soundbar” on page 15.
4. Remove the Stylus Pen. See “Remove the Stylus Pen” on page 16.
5. Disconnect the power cord from electrical outlet and disconnect all the cables from the device.
6. Place a clean soft cloth, and then lay down the device with the back cover facing up.
7. Remove the stand with base. See “Remove the stand with base” on page 16.
8. Remove the back cover. See “Remove the back cover” on page 20.

9. Remove the shielding bracket with cover. See “Remove the shielding bracket with cover” on page 23.

### Removal steps

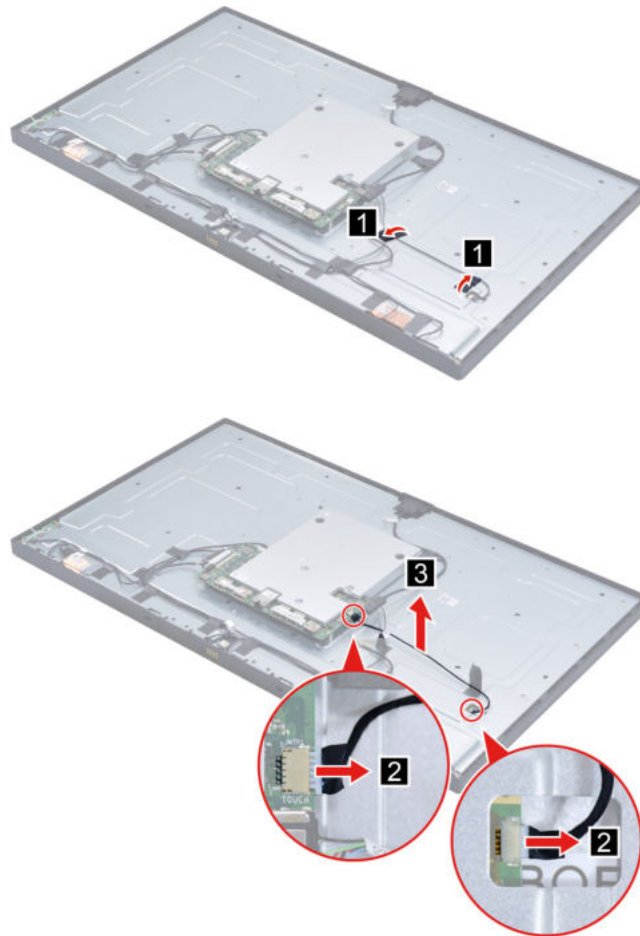

---

## Remove the Wi-Fi antennas

### Prerequisite

Turn off ThinkSmart View Plus and wait several minutes until it is cool.

For access, do the following:

1. Remove the cable tie. See “Remove the cable tie” on page 14.
2. Remove the camera module. See “Remove the camera module” on page 15.
3. Remove the Soundbar. See “Remove the Soundbar” on page 15.
4. Remove the Stylus Pen. See “Remove the Stylus Pen” on page 16.
5. Disconnect the power cord from electrical outlet and disconnect all the cables from the device.
6. Place a clean soft cloth, and then lay down the device with the back cover facing up.
7. Remove the stand with base. See “Remove the stand with base” on page 16.
8. Remove the back cover. See “Remove the back cover” on page 20.
9. Remove the shielding bracket with cover. See “Remove the shielding bracket with cover” on page 23.
10. Remove the heat sink. See “Remove the heat sink” on page 18.

## Removal steps

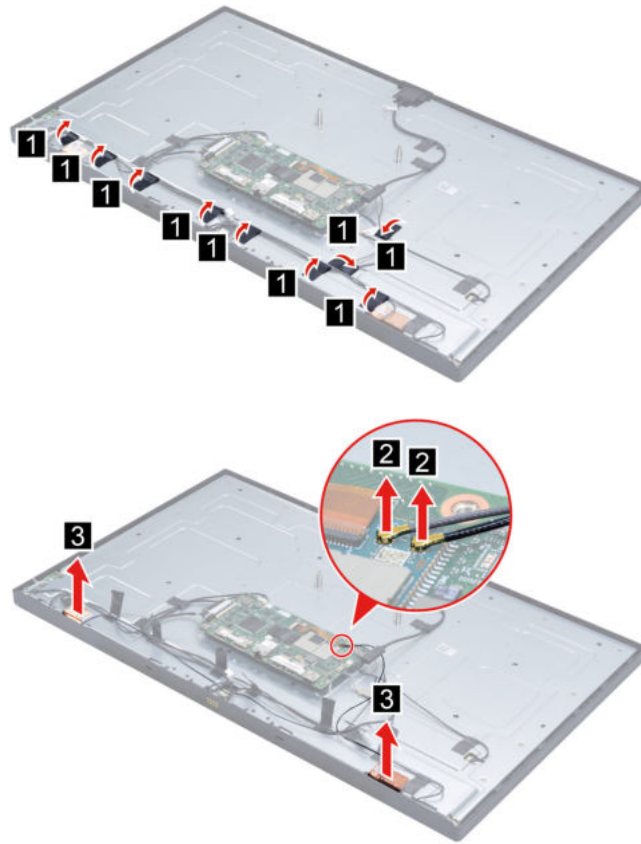

---

## Remove the system board

### Prerequisite

Turn off ThinkSmart View Plus and wait several minutes until it is cool.

For access, do the following:

1. Remove the cable tie. See “Remove the cable tie” on page 14.
2. Remove the camera module. See “Remove the camera module” on page 15.
3. Remove the Soundbar. See “Remove the Soundbar” on page 15.
4. Remove the Stylus Pen. See “Remove the Stylus Pen” on page 16.
5. Disconnect the power cord from electrical outlet and disconnect all the cables from the device.
6. Place a clean soft cloth, and then lay down the device with the back cover facing up.
7. Remove the stand with base. See “Remove the stand with base” on page 16.
8. Remove the back cover. See “Remove the back cover” on page 20.
9. Remove the shielding bracket with cover. See “Remove the shielding bracket with cover” on page 23.
10. Remove the heat sink. See “Remove the heat sink” on page 18.

## Removal steps

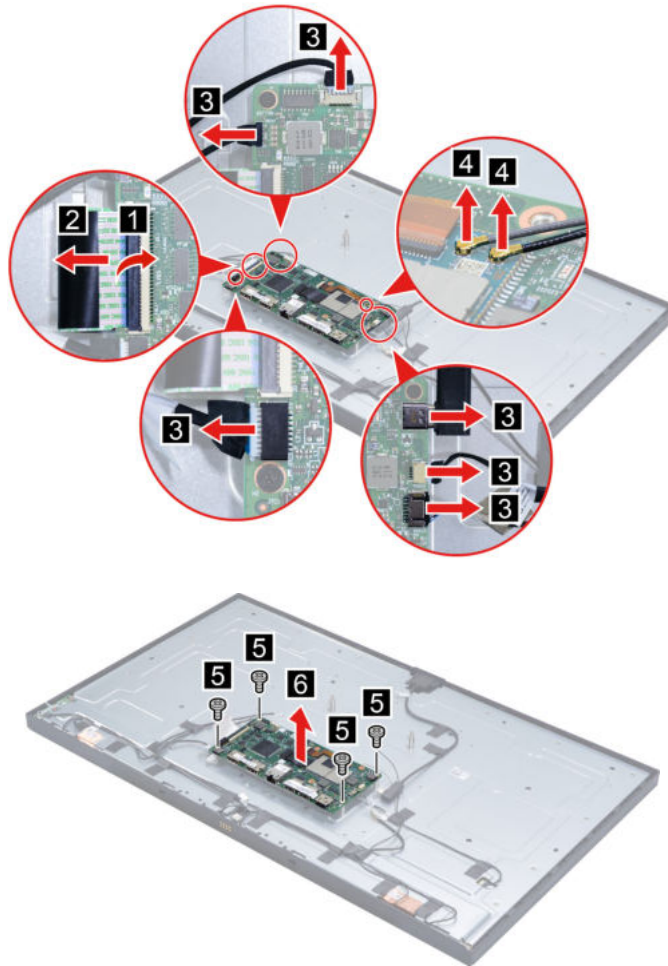

**Attention:** Use the screws provided by Lenovo to avoid any unpredictable damage to your device.

Step	Screw (quantity)	Color	Torque
5	M3 × 3.5 mm, flat-head (4)	Black	0.18±0.05 Nm (1.8±0.5 kgf-cm)

## Remove the back bracket

### Prerequisite

Turn off ThinkSmart View Plus and wait several minutes until it is cool.

For access, do the following:

1. Remove the cable tie. See “Remove the cable tie” on page 14.
2. Remove the camera module. See “Remove the camera module” on page 15.
3. Remove the Soundbar. See “Remove the Soundbar” on page 15.
4. Remove the Stylus Pen. See “Remove the Stylus Pen” on page 16.
5. Disconnect the power cord from electrical outlet and disconnect all the cables from the device.

6. Place a clean soft cloth, and then lay down the device with the back cover facing up.
7. Remove the stand with base. See “Remove the stand with base” on page 16.
8. Remove the back cover. See “Remove the back cover” on page 20.
9. Remove the power lens. See “Remove the power lens” on page 21.
10. Remove the power button board. See “Remove the power button board” on page 22.
11. Remove the shielding bracket with cover. See “Remove the shielding bracket with cover” on page 23.
12. Remove the power button cable. See “Remove the power button cable” on page 25.
13. Remove the P sensor cable. See “Remove the P sensor cable” on page 27.
14. Remove the heat sink. See “Remove the heat sink” on page 18.
15. Remove the system board. See “Remove the system board” on page 30.

### Removal steps

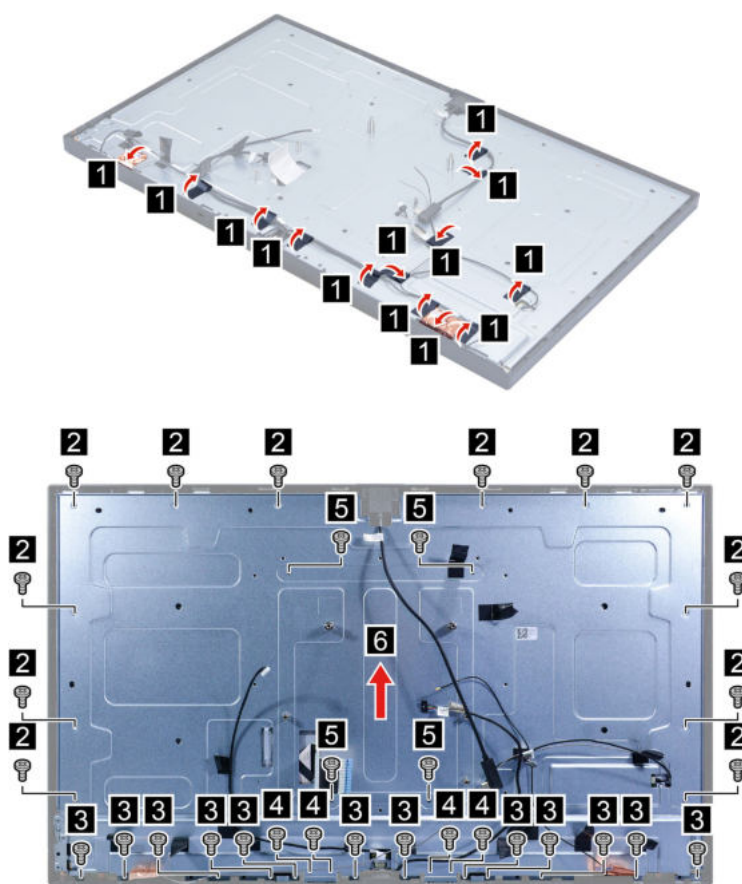

**Attention:** Use the screws provided by Lenovo to avoid any unpredictable damage to your device.

Step	Screw (quantity)	Color	Torque
<b>2</b>	M3 × 4.5 mm, flat-head (12)	Silver	0.18±0.05 Nm (1.8±0.5 kgf-cm)
<b>3</b>	M2 × 4.5 mm, flat-head (12)	Black	0.18±0.05 Nm (1.8±0.5 kgf-cm)

Step	Screw (quantity)	Color	Torque
4	M2 × 3 mm, flat-head (4)	Silver	0.18±0.05 Nm (1.8±0.5 kgf-cm)
5	M3 × 3.5 mm, flat-head (4)	Black	0.18±0.05 Nm (1.8±0.5 kgf-cm)

## Remove the LVDS cable

### Prerequisite

Turn off ThinkSmart View Plus and wait several minutes until it is cool.

For access, do the following:

1. Remove the cable tie. See “Remove the cable tie” on page 14.
2. Remove the camera module. See “Remove the camera module” on page 15.
3. Remove the Soundbar. See “Remove the Soundbar” on page 15.
4. Remove the Stylus Pen. See “Remove the Stylus Pen” on page 16.
5. Disconnect the power cord from electrical outlet and disconnect all the cables from the device.
6. Place a clean soft cloth, and then lay down the device with the back cover facing up.
7. Remove the stand with base. See “Remove the stand with base” on page 16.
8. Remove the back cover. See “Remove the back cover” on page 20.
9. Remove the power lens. See “Remove the power lens” on page 21.
10. Remove the power button board. See “Remove the power button board” on page 22.
11. Remove the shielding bracket with cover. See “Remove the shielding bracket with cover” on page 23.
12. Remove the power button cable. See “Remove the power button cable” on page 25.
13. Remove the P sensor cable. See “Remove the P sensor cable” on page 27.
14. Remove the heat sink. See “Remove the heat sink” on page 18.
15. Remove the system board. See “Remove the system board” on page 30.
16. Remove the back bracket. See “Remove the back bracket” on page 31.

### Removal step

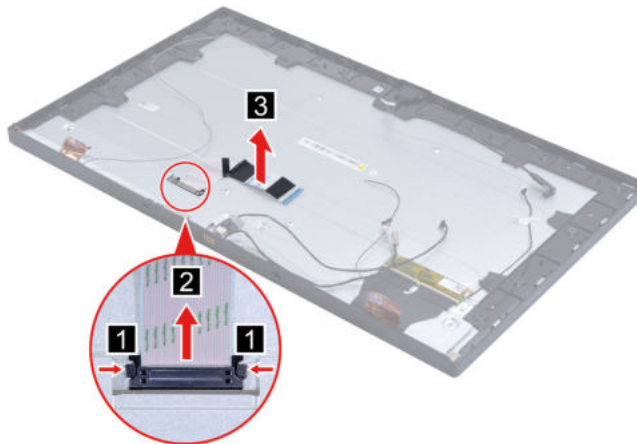

---

## Remove the bezel

### Prerequisite

Turn off ThinkSmart View Plus and wait several minutes until it is cool.

For access, do the following:

1. Remove the cable tie. See “Remove the cable tie” on page 14.
2. Remove the camera module. See “Remove the camera module” on page 15.
3. Remove the Soundbar. See “Remove the Soundbar” on page 15.
4. Remove the Stylus Pen. See “Remove the Stylus Pen” on page 16.
5. Disconnect the power cord from electrical outlet and disconnect all the cables from the device.
6. Place a clean soft cloth, and then lay down the device with the back cover facing up.
7. Remove the stand with base. See “Remove the stand with base” on page 16.
8. Remove the back cover. See “Remove the back cover” on page 20.
9. Remove the power lens. See “Remove the power lens” on page 21.
10. Remove the power button board. See “Remove the power button board” on page 22.
11. Remove the shielding bracket with cover. See “Remove the shielding bracket with cover” on page 23.
12. Remove the camera cable. See “Remove the camera cable” on page 24.
13. Remove the power button cable. See “Remove the power button cable” on page 25.
14. Remove the P sensor cable. See “Remove the P sensor cable” on page 27.
15. Remove the heat sink. See “Remove the heat sink” on page 18.
16. Remove the system board. See “Remove the system board” on page 30.
17. Remove the back bracket. See “Remove the back bracket” on page 31.

### Removal step

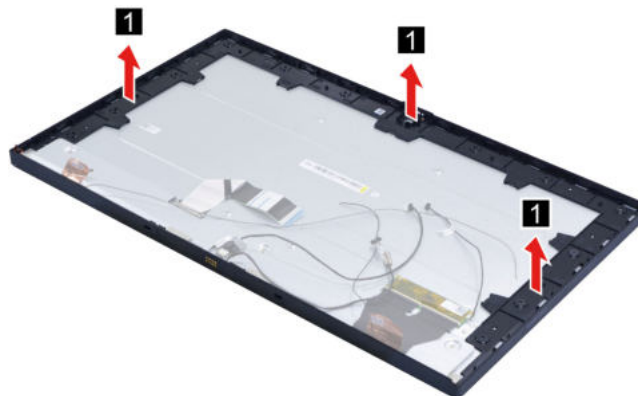

---

## Remove the panel

### Prerequisite

Turn off ThinkSmart View Plus and wait several minutes until it is cool.

For access, do the following:



1. Remove the cable tie. See “Remove the cable tie” on page 14.
2. Remove the camera module. See “Remove the camera module” on page 15.
3. Remove the Soundbar. See “Remove the Soundbar” on page 15.
4. Remove the Stylus Pen. See “Remove the Stylus Pen” on page 16.
5. Disconnect the power cord from electrical outlet and disconnect all the cables from the device.
6. Place a clean soft cloth, and then lay down the device with the back cover facing up.
7. Remove the stand with base. See “Remove the stand with base” on page 16.
8. Remove the back cover. See “Remove the back cover” on page 20.
9. Remove the power lens. See “Remove the power lens” on page 21.
10. Remove the power button board. See “Remove the power button board” on page 22.
11. Remove the shielding bracket with cover. See “Remove the shielding bracket with cover” on page 23.
12. Remove the camera cable. See “Remove the camera cable” on page 24.
13. Remove the power button cable. See “Remove the power button cable” on page 25.
14. Remove the system board panel cable. See “Remove the system board panel cable” on page 26.
15. Remove the P sensor cable. See “Remove the P sensor cable” on page 27.
16. Remove the system board touch cable. See “Remove the system board touch cable” on page 28.
17. Remove the heat sink. See “Remove the heat sink” on page 18.
18. Remove the Wi-Fi antennas. See “Remove the Wi-Fi antennas” on page 29.
19. Remove the system board. See “Remove the system board” on page 30.
20. Remove the back bracket. See “Remove the back bracket” on page 31.
21. Remove the LVDS cable. See “Remove the LVDS cable” on page 33.
22. Remove the bezel. See “Remove the bezel” on page 34.



---

## Chapter 4. Help and support

This chapter describes the various help and support resources.

---

### Help resources

Use the following resources to learn more about the product and support.

Resource	How to access?
<b>Support and service:</b> <ul style="list-style-type: none"><li>• Frequently Asked Questions</li><li>• Troubleshooting</li><li>• Recovery</li><li>• Drivers and Software</li></ul>	Go to <a href="https://smartsupport.lenovo.com/">https://smartsupport.lenovo.com/</a> , enter the product name, Machine Type or Serial Number and find the resources you want.
<b>Microsoft Teams display</b>	Go to: <a href="https://support.lenovo.com/solutions/ht514685">https://support.lenovo.com/solutions/ht514685</a>
<b>Lenovo ThinkSmart Manager Service*</b>	Go to: <a href="https://support.lenovo.com/solutions/tsm">https://support.lenovo.com/solutions/tsm</a>

\* for selected models



---

# Appendix A. Serial Number Location

Refer to the illustrations to find your product Serial Number.





---

## Appendix B. Notices and trademarks

### Notices

Lenovo may not offer the products, services, or features discussed in this document in all countries. Consult your local Lenovo representative for information on the products and services currently available in your area. Any reference to a Lenovo product, program, or service is not intended to state or imply that only that Lenovo product, program, or service may be used. Any functionally equivalent product, program, or service that does not infringe any Lenovo intellectual property right may be used instead. However, it is the user's responsibility to evaluate and verify the operation of any other product, program, or service.

Lenovo may have patents or pending patent programs covering subject matter described in this document. The furnishing of this document does not give you any license to these patents. You can send license inquiries, in writing, to:

*Lenovo (United States), Inc.  
8001 Development Drive  
Morrisville, NC 27560  
U.S.A.  
Attention: Lenovo Director of Licensing*

LENOVO PROVIDES THIS PUBLICATION "AS IS" WITHOUT WARRANTY OF ANY KIND, EITHER EXPRESS OR IMPLIED, INCLUDING, BUT NOT LIMITED TO, THE IMPLIED WARRANTIES OF NON-INFRINGEMENT, MERCHANTABILITY OR FITNESS FOR A PARTICULAR PURPOSE. Some jurisdictions do not allow disclaimer of express or implied warranties in certain transactions, therefore, this statement may not apply to you.

Changes are made periodically to the information herein; these changes will be incorporated in new editions of the publication. To provide better service, Lenovo reserves the right to improve and/or modify the products and software programs described in the manuals included with your product, and the content of the manual, at any time without additional notice.

The software interface and function and hardware configuration described in the manuals included with your product might not match exactly the actual configuration of the product that you purchase. For the configuration of the product, refer to the related contract (if any) or product packing list, or consult the distributor for the product sales. Lenovo may use or distribute any of the information you supply in any way it believes appropriate without incurring any obligation to you.

The products described in this document are not intended for use in implantation or other life support applications where malfunction may result in injury or death to persons. The information contained in this document does not affect or change Lenovo product specifications or warranties. Nothing in this document shall operate as an express or implied license or indemnity under the intellectual property rights of Lenovo or third parties. All information contained in this document was obtained in specific environments and is presented as an illustration. The result obtained in other operating environments may vary.

Lenovo may use or distribute any of the information you supply in any way it believes appropriate without incurring any obligation to you.

Any references in this publication to non-Lenovo Web sites are provided for convenience only and do not in any manner serve as an endorsement of those Web sites. The materials at those Web sites are not part of the materials for this Lenovo product, and use of those Web sites is at your own risk.

Any performance data contained herein was determined in a controlled environment. Therefore, the result obtained in other operating environments may vary significantly. Some measurements may have been made on development-level systems and there is no guarantee that these measurements will be the same on generally available systems. Furthermore, some measurements may have been estimated through extrapolation. Actual results may vary. Users of this document should verify the applicable data for their specific environment.

This document is copyrighted by Lenovo and is not covered by any open source license, including any Linux agreement(s) which may accompany software included with this product. Lenovo may update this document at any time without notice.

For the latest information or any questions or comments, contact or visit the Lenovo Web site:

<https://support.lenovo.com/>

### **Trademarks**

LENOVO, LENOVO logo, THINKSMART and THINKSMART logo are trademarks of Lenovo. Microsoft Teams is a trademark of the Microsoft group of companies. DisplayPort is a trademark of the Video Electronics Standards Association. Wi-Fi is a registered trademark of Wi-Fi Alliance. USB-C is a registered trademark of USB Implementers Forum. All other trademarks are the property of their respective owners. © 2023 Lenovo.





**Lenovo**