



Owner's Manual



(LED Monitor*)

* LG LED Monitor applies LCD screen with LED backlights.

Please read this manual carefully before operating your set and retain it for future reference.

27GS60QC

27GS60QX

27GS60QN

32GS60QC

32GS60QX

www.lg.com

Copyright © 2024 LG Electronics Inc. All Rights Reserved.

TABLE OF CONTENTS

ASSEMBLING AND PREPARING	4	USING THE MONITOR.....	12
- Installing.....	5	- Connecting to a PC	12
Moving and Lifting the Monitor	5	HDMI Connection	12
Installing on a Table	6	DisplayPort Connection	13
Using the Kensington Lock	6	- Connecting AV Devices	13
Installing on the Wall	7	HDMI Connection	13
- Product Description.....	10	- Connecting Peripherals	14
How to Use the Joystick Button	10	Headphones Connection	14
Adjusting the Angle	11		
- Supported Software.....	11		

USER SETTINGS	14
- Activating the Main Menu	14
Main Menu Features.....	15
Menu Settings.....	15
[Game Mode]	16
[Game Adjust]	17
[Picture Adjust]	18
[Input].....	19
[General]	19

PRODUCT SPECIFICATION	20
- Support Mode	22
(Preset Mode, HDMI)	22
(Preset Mode, DisplayPort).....	23
HDMI Timing (Video)	24
TROUBLESHOOTING	25
LICENSE	27
OPEN SOURCE SOFTWARE NOTICE INFORMATION	27
BEEP GUIDE	28

ASSEMBLING AND PREPARING

CAUTION

- Always use genuine LG components to ensure safety and product performance.
- The product warranty will not cover damage or injury caused by the use of unauthorized components.
- It is recommended that use the supplied components.
- The product figures and screen displays used in this manual are examples to help consumers use the product and may differ from the actual product.
- Do not apply foreign substances (oils, lubricants, etc.) to the screw parts when assembling the product. (Doing so may damage the product.)
- Applying excessive force when tightening screws may cause damage to the monitor. Damage caused in this way will not be covered by the product warranty.
- Do not carry the monitor upside down by just holding the base. This may cause the monitor to fall off the stand and could result in personal injury.
- When lifting or moving the monitor, do not touch the monitor screen. The force applied to the monitor screen may cause damage to it.
- For wave pattern on appearance, unlike the general method of coating, it's applied to added glittering material in raw material. With no peeled-off appearance, it has good durability. Please use it with confidence because there is no problem in using the product at all.

NOTE

- The components may look different from those illustrated here.
- Without prior notice, all product information and specifications contained in this manual are subject to change to improve the performance of the product.
- To purchase optional accessories, visit an electronics store or an online shopping site, or contact the retailer from which you purchased the product.
- The power cord provided may differ depending upon the region.

Installing

Moving and Lifting the Monitor

When moving or lifting the monitor, follow these instructions to prevent the monitor from being scratched or damaged and to ensure safe transportation, regardless of its shape or size.

- Place the monitor in the original box or packing material before attempting to move it.
- Before moving or lifting the monitor, disconnect the power cord and all other cables.
- Hold the bottom and side of the monitor frame firmly. Do not hold the panel itself.
- When holding the monitor, the screen should face away from you to prevent it from being scratched.
- When transporting the monitor, do not expose the monitor to shock or excessive vibration.
- When moving the monitor, keep it upright and never turn the monitor on its side or tilt it sideways.

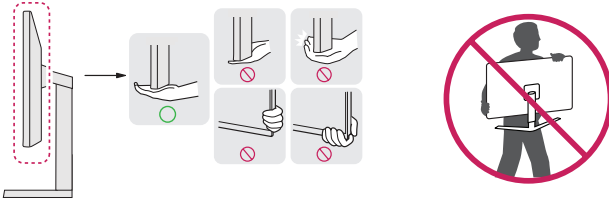

⚠ CAUTION

- Avoid touching the monitor screen as much as possible.
 - This may result in damage to the screen or some of the pixels used to create images.
- If you use the monitor panel without the stand base, its joystick button may cause the monitor to become unstable and fall, resulting in damage to the monitor or human injury. In addition, this may cause the joystick button to malfunction.

Installing on a Table

- Lift the monitor and place it on the table in an upright position. Place the monitor at least 100 mm (3.9 inches) away from the wall to ensure sufficient ventilation.

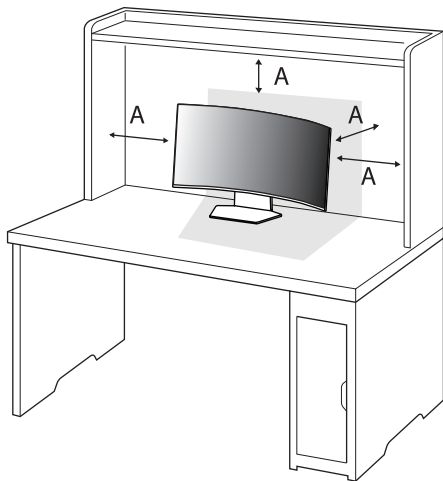

A: 100 mm (3.9 inches)

CAUTION

- Unplug the power cord before moving or installing the monitor. There is risk of electric shock.
- Make sure to use the power cord that is provided in the product package and connect it to a grounded power outlet.
- If you need another power cord, please contact your local dealer or the nearest retail store.

Using the Kensington Lock

For more information on installation and usage, refer to the Kensington lock owner's manual or visit the website at <http://www.kensington.com>.

Connect the monitor to a table using the Kensington security system cable.

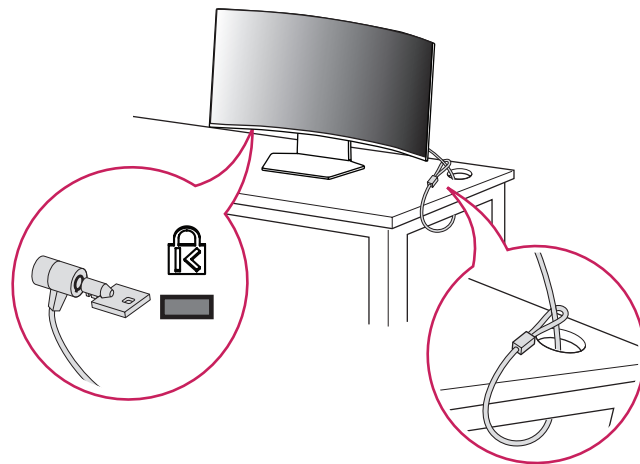

NOTE

- The Kensington security system is optional. You can obtain optional accessories from most electronics stores.

Installing on the Wall

This monitor meets the specifications for the wall mount plate or other compatible devices. Install the monitor at least 100 mm (3.9 inches) away from the wall and leave about 100 mm (3.9 inches) of space at each side of the monitor to ensure sufficient ventilation. Detailed installation instructions can be obtained from your local retail store. Alternatively, please refer to the manual for how to install and set up a tilting wall mounting bracket.

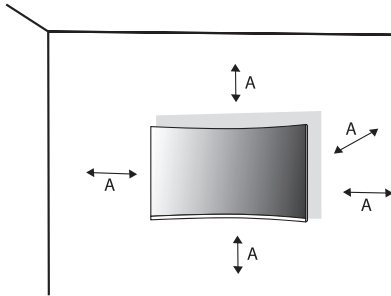

A: 100 mm (3.9 inches)

Installing the Wall Mount Plate

When installing the monitor on a wall, attach the Wall mount plate (optional) to the back of the monitor using the wall mount bracket cover provided with the monitor, as shown in the figure below.

Make sure that the wall mounting bracket is securely fixed to the monitor and to the wall.

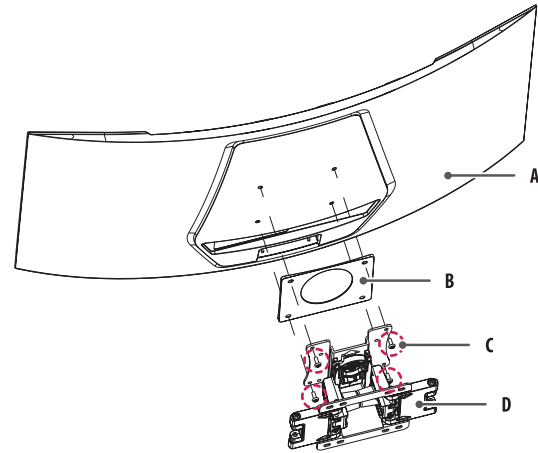

- A: Monitor
- B: Wall mount bracket Cover
- C: Screw (M4 x L17)*
- D: Wall mount bracket (optional)

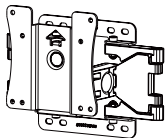
Wall Mount (mm)	100 x 100 (3.9 x 3.9 inches)
Standard screw	M4 x L10*
Number of screws	4
Wall Mount Plate (Optional)	LSW149 

* Make sure to use the screws (M4 x L17) provided with the monitor instead of those on the wall mounting plate when installing.

NOTE

- Use the screws specified by VESA standards.
- The wall mount kit includes the installation guide and all necessary parts.
- The wall mounting bracket is optional. You can obtain optional accessories from your local dealer.
- The length of the screw may differ for each wall mounting bracket. If you use screws longer than the standard length, it may damage the inside of the product.
- For more information, please refer to the user manual for the wall mounting bracket.
- Be careful not to apply too much force while mounting the wall mount plate as it may cause damage to the screen.
- Remove the stand before installing the monitor on a wall mount by performing the stand attachment in reverse.

CAUTION

- Unplug the power cord before moving or installing the monitor to avoid electric shock.
- Installing the monitor on the ceiling or on a slanted wall may result in the monitor falling off, which could lead to injury. Use an authorized LG wall mount and contact the local dealer or qualified personnel.
- To prevent injury, this apparatus must be securely attached to the wall in accordance with the installation instructions.
- Applying excessive force when tightening screws may cause damage to the monitor. Damage caused in this way will not be covered by the product warranty.
- Use the wall mounting bracket and screws that conform to VESA standards. Damage caused by the use or misuse of inappropriate components will not be covered by the product warranty.
- When measured from the back of the monitor, the length of each installed screw must be 12 mm (0.4 inches) or less.

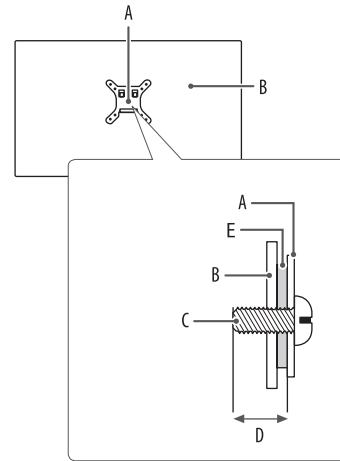

- A: Wall Mount Plate
- B: Back of the Monitor
- C: Screw (M4 x L17)
- D: Max. 12 mm (0.4 inches)
- E: Wall mount bracket Cover

Product Description

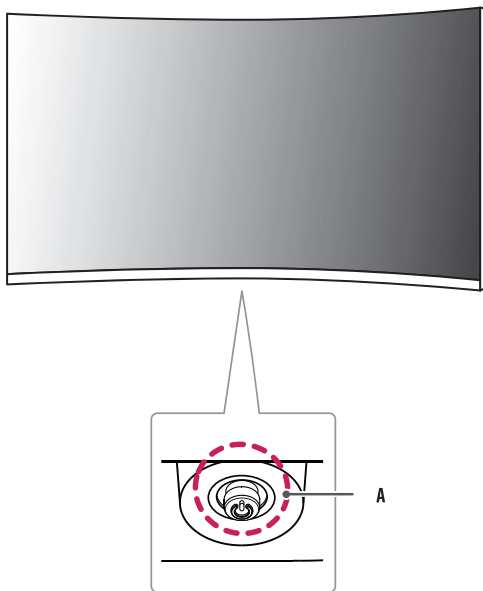

A: Joystick Button

How to Use the Joystick Button

You can easily control the functions of the monitor by pressing the joystick button or moving it left/right/up/down with your finger.

Basic Functions

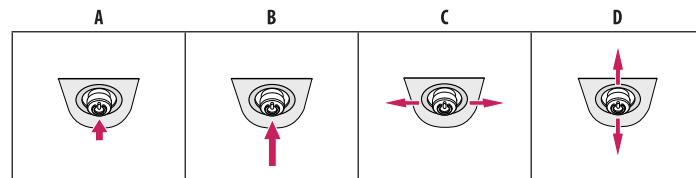

A (Power on): Press the joystick button once with your finger to turn on the monitor.

B (Power off): Press and hold the joystick button once more than 5 seconds with your finger to turn off the monitor.

C (Volume control): You can control the volume by moving the joystick button left/right.

D: Enters the [Accessibility] menu.

Adjusting the Angle

- 1 Place the monitor mounted on the stand base in an upright position.
- 2 Adjust the angle of the screen.

The angle of the screen can be adjusted forward or backward from -5° to 22° for a comfortable viewing experience.

WARNING

- To avoid injury to the fingers when adjusting the screen, do not hold the lower part of the monitor's frame as illustrated below.
- Be careful not to touch or press the screen area when adjusting the angle of the monitor.

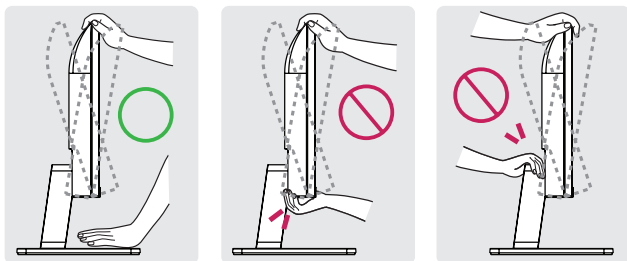

Supported Software

You can download and install the latest version from the LGE website (www.lg.com).

- Monitor Driver / OnScreen Control / Dual Controller

USING THE MONITOR

- Illustrations in this manual may differ from the actual product.
- Press the joystick button, go to [Menu] > [Input], and then select the input option.

CAUTION

- If you use generic cables not certified by LG, the screen may not display or there may be image noises.
- Do not press the screen for a prolonged time. This may cause image distortion.
- Do not display a still image on the screen for a prolonged time. This may cause image retention. Use a PC screensaver if possible.
- When connecting the power cord to the outlet, use a grounded (3-hole) power strip or a grounded power outlet.
- The monitor may flicker when turned on in an area where the temperature is low. This is normal.
- Sometimes red, green, or blue spots may appear on the screen. This is normal.
- Make sure to use the supplied cable of the product. Otherwise, this may cause the device to malfunction.

Connecting to a PC

- This monitor supports the Plug and Play* feature.
- * Plug and Play: A feature that allows you to add a device to your computer without having to reconfigure anything or install any manual drivers.

HDMI Connection

Transmits digital video and audio signals from your PC to the monitor.

NOTE

- Using a DVI to HDMI / DP (DisplayPort) to HDMI cable may cause compatibility issues.
- Use a certified cable with the HDMI logo attached. If you do not use a certified HDMI cable, the screen may not display or a connection error may occur.
- Recommended HDMI cable types
 - High Speed HDMI®/™ cable
 - High Speed HDMI®/™ cable with Ethernet

DisplayPort Connection

Transmits digital video and audio signals from your PC to the monitor.

! NOTE

- There may be no video or audio output depending on the DP (DisplayPort) version of the PC.
- If you are using a Mini DisplayPort output graphics card, use a Mini DP to DP (Mini DisplayPort to DisplayPort) cable or gender that supports DisplayPort1.4. (Sold separately)

Connecting AV Devices

HDMI Connection

HDMI transmits digital video and audio signals from your AV device to the monitor.

! NOTE

- Using a DVI to HDMI / DP (DisplayPort) to HDMI cable may cause compatibility issues.
- Use a certified cable with the HDMI logo attached. If you do not use a certified HDMI cable, the screen may not display or a connection error may occur.
- Recommended HDMI cable types
 - High Speed HDMI[®]/™ cable
 - High Speed HDMI[®]/™ cable with Ethernet

Connecting Peripherals

Headphones Connection

Connect peripherals to the monitor via the headphones port.

NOTE

- Peripheral devices are sold separately.
- Depending on the audio settings of the PC and external device, headphones and speaker functions may be limited.
- If you use angled earphones, it may cause a problem with connecting another external device to the monitor. Therefore, it is recommended to use straight earphones.



Angled



Straight
(Recommend)

USER SETTINGS

NOTE

- Your monitor's OSD (On Screen Display) may differ slightly from that shown in this manual.
- When [Beep Guide] is activated, pressing the joystick button will take you to [Menu] right away.

Activating the Main Menu



Joystick Button

- 1 Press the joystick button on the bottom of the monitor.
- 2 Move the joystick up/down and left/right to set the options.

Main Menu Features

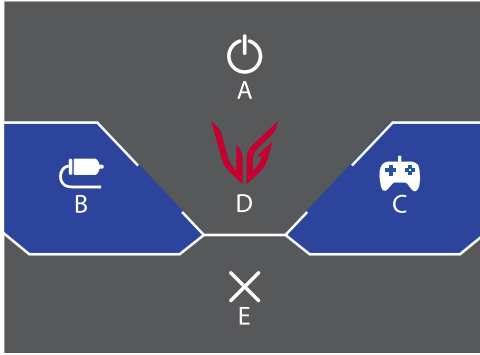

Main Menu	Description
A: [Power Off]	Turns off the monitor.
B: [Input]	Sets input mode.
C: [Game Mode]	Sets the game mode for gaming.
D: [Menu]	Configures the screen settings.
E: [Exit]	Exits the main menu.

Menu Settings

- 1 To view the OSD menu, press the joystick button at the bottom of the monitor and then enter the [Menu].
- 2 Move the joystick up/down and left/right to set the options.
- 3 To return to the upper menu or set other menu items, move the joystick to ◀ or pressing (⏪) it.
- 4 If you want to exit the OSD menu, move the joystick to ◀ until you exit.



[Game Adjust]



[Picture Adjust]



[Input]



[General]

[Game Mode]

[Menu] > [Game Adjust] > [Game Mode]

[Game Mode] on SDR(Non-HDR) signal

- [Gamer 1]/[Gamer 2]: [Gamer 1] and [Gamer 2] picture modes allow you to save two sets of customized display settings, including game-related setup options.
- [FPS]: This mode is optimized for FPS games. It is suitable for very dark FPS games.
- [RTS]: This mode is optimized for RTS Game.
- [Vivid]: Optimized the screen for vivid colors.
- [Reader]: Optimizes the screen for reading documents. You can brighten the screen in the OSD menu.
- [HDR Effect]: Optimises the screen for high dynamic range.
- [Color Weakness]: This mode is for users who cannot distinguish between red and green. It enables users with color weakness to easily distinguish between the two colors.
 - This is subsidiary for color weakness user. Therefore if you feel uncomfortable with the screen, please turn off this function.
 - This function can't distinguish some colors in some images.

[Game Mode] on HDR signal

- [Gamer 1]/[Gamer 2]: [Gamer 1] and [Gamer 2] picture modes allow you to save two sets of customized display settings, including game-related setup options.
- [FPS]: This mode is optimized for FPS games. It is suitable for very dark FPS games.
- [RTS]: This mode is optimized for RTS Game.
- [Vivid]: Optimized the screen for vivid colors.

! NOTE

- The [Game Mode] can be set depends on the Input signal.
- If the [Game Mode] is changed in the DP (DisplayPort) input, the screen may flicker or the resolution of your PC screen may be affected.
- HDR content may not display correctly depending on Windows 10 OS settings, please check HDR On/Off settings in Windows.
- When the HDR function is turned on, the characters or picture quality may be poor according to Graphic card performance.
- While the HDR function is on, screen flickering or cracking may occur when changing the monitor input or power on/off according to Graphic card performance.
- For information about whether the graphics card and game support HDR, visit their manufacture's website.

[Game Adjust]

[Menu] > [Game Adjust]

- [FreeSync]/ [Adaptive-Sync]: Provides seamless and natural images in a gaming environment. Note that the screen flickering may occur intermittently in a specific gaming environment.
 - [Extended]: [FreeSync]/ [Adaptive-Sync] function on. (Enable wider frequency range of [FreeSync] function than basic mode.)
 - [Basic]: [FreeSync]/ [Adaptive-Sync] function on. (Enable basic frequency range of [FreeSync] function.)
 - [Off]: [FreeSync]/ [Adaptive-Sync] function off.
 - Supported Interface: DisplayPort (Adaptive-Sync), HDMI (FreeSync).
 - Supported Graphic Card: A graphic card that supports AMD's FreeSync is necessary.
 - Supported Version: Make sure to update the graphic card to the latest driver.
 - For more information and requirement, refer to AMD website (www.amd.com).
- [Black Stabilizer]: You can control the black contrast to have better visibility in dark scenes. You can easily distinguish objects on dark game screens.
- [Response Time]: Sets a response time for displayed pictures based on the speed of the screen.
 - For a normal environment, it is recommended that you use [Fast].
 - For a fast-moving picture, it is recommended that you use [Faster].
 - Once [Faster] mode is selected, Motion Blur may occur depending on the content.
 - [Faster]: Sets the response time to faster.
 - [Fast]: Sets the response time to fast.
 - [Normal]: Sets the response time to normal.
 - [Off]: Disables the feature.
- [Crosshair]: Crosshair provides a mark on the center of the screen for First Person Shooter (FPS) games. Users can select the crosshair that fits their gaming environment among four different crosshairs.
- [FPS Counter]
 - [On]: The indicator is displayed on the upper left of the screen. It will reflect the actual frame rate that is received at the input.
 - [Off]: Does not use the FPS Counter feature.
 - [FPS Counter] and [Crosshair] feature can not be used at the same time.
- [Game Reset]: Returns game to the default settings.

[Picture Adjust]

[Menu] > [Picture Adjust]

- [Brightness]: Adjusts the brightness of the screen.
- [Contrast]: Adjusts the contrast of the screen.
- [Sharpness]: Adjusts the sharpness of the screen.
- [Gamma]
 - [Mode 1], [Mode 2], [Mode 3]: The higher the gamma value, the darker the image becomes. Likewise, the lower the gamma value, the lighter the image becomes.
 - [Mode 4]: If you do not need to adjust the gamma settings, select [Mode 4].
- [Color Temp]: Set your own color temperature.
 - [Custom]: The user can customize the red, green and blue color.
 - [Warm]: Sets the screen color to a reddish tone.
 - [Medium]: Sets the screen color to between a red and blue tone.
 - [Cool]: Sets the screen color to a bluish tone.
 - [Manual]: The user can fine-tune the color temperature.
- [R/G/B]: You can customize the picture color using red, green, and blue colors.
 - [Six Color]: Meets the user requirements for colors by adjusting the hue and saturation of the six colors (red, green, blue, cyan, magenta, and yellow) and then saving the settings.
 - Hue: Adjusts the tone of the screen colors.
 - Saturation: Adjusts the saturation of the screen colors. The lower the value, the less saturated and brighter the colors become. The higher the value, the more saturated and darker the colors become.
 - [Black Level]: Sets the offset level (for HDMI only).
 - [High]: Keeps the current contrast ratio of the screen.
 - [Low]: Lowers the black levels and raises the white levels from the current contrast ratio of the screen.
 - [Picture Reset]: Returns picture and color to the default settings.

[Input]

[Menu] > [Input]

- [Input List]: Selects the input mode.
- [Aspect Ratio]: Adjusts the aspect ratio of the screen. The display may look the same for [Full Wide], and [Original] options at the recommended resolution (2560 x 1440).
 - [Full Wide]: Displays the video in widescreen, regardless of the video signal input.
 - [Original]: Displays video according to the aspect ratio of the video signal input.
 - The menus may be disabled at the recommended resolution (2560 x 1440).
- [Auto Input Switch]: When [Auto Input Switch] is set to [On], display will automatically switch to new input when connected.

[General]

[Menu] > [General]

- [Language]: Sets the menu screen to the desired language.
- [User-defined Key 1] / [User-defined Key 2]: You can customize the main menu to access your preferred menu easily. [User-defined Key 1] and [User-defined Key 2] appear at the left/right of the main menu.
- [SMART ENERGY SAVING]: Conserve energy by using luminance compensation algorithm.
 - [High]: Saves energy using the high-efficiency [SMART ENERGY SAVING] feature.
 - [Low]: Saves energy using the low-efficiency [SMART ENERGY SAVING] feature.
 - [Off]: Disables the feature.
 - The value of energy saving data may differ depending on panel and panel suppliers.
 - If you select the option of [SMART ENERGY SAVING] is [High] or [Low], monitor luminance becomes lower or higher depending on source.
- [Deep Sleep Mode]: When Deep Sleep mode is enabled, power consumption is minimized while the monitor is in standby mode.
 - [On]: Enables [Deep Sleep Mode].
 - [Off]: Disables the feature.
- [Automatic Standby]: If there is no operation on the monitor for a certain period of time, the monitor will automatically switch to standby mode.

- [Input Compatibility Version]: You can set each input to match the supported version of the connected device.
- [Buzzer]: This feature lets you set the sound generated from Buzzer when your monitor powers on.
- [OSD Lock]: This feature disables the configuration and adjustment of menus.
All features are disabled except:
 - [Brightness] / [Contrast] in [Picture Adjust]
 - [Input]
 - [OSD Lock] / [Information] / [Open Source Software License] in [General]
- [Information]: The following display information will be shown; [Total Power On Time], [Resolution].
- [Open Source Software License]: If you select the [View], you can check the Open Source Software notice information.
- [Reset to Initial Settings]: Returns to the default settings.

PRODUCT SPECIFICATION

Specifications are subject to change without notice.

The symbol ~ means alternating current, and the symbol --- means direct current.

Color Depth:

- 8-bit color is supported.

Resolution

- Max Resolution:
 - 2560 x 1440 @ 180 Hz (DisplayPort)
 - 2560 x 1440 @ 144 Hz (HDMI)
- Recommended Resolution:
 - 2560 x 1440 @ 180 Hz (DisplayPort)
 - 2560 x 1440 @ 144 Hz (HDMI)

Environmental Conditions

- Operating Conditions
 - Temperature: 0 °C to 40 °C (32 °F to 104 °F)
 - Humidity: Less than 80 %
- Storing Conditions
 - Temperature: -20 °C to 60 °C (-4 °F to 140 °F)
 - Humidity: Less than 85 %

AC/DC Adapter

27GS60QC/ 27GS60QX/ 27GS60QN

- Model: ADS-45FSQ-19 19040EPG-1
ADS-45FSQ-19 19040EPCU-1
ADS-45SQ-19-3 19040E
- Manufacturer: SHENZHEN HONOR ELECTRONIC CO., LTD
 - Input: 100-240 V~ 50/60 Hz, 1.2 A
 - Output: 19V --- 2.1 A

32GS60QC/ 32GS60QX

- Model: MS-V2530R190-048LO-DE
MS-V2530R190-048LO-US
- Manufacturer: JAMA Technology (HongKong) Co., Ltd
 - Input: 100-240 V~ 50/60 Hz, 1.5 A
 - Output: 19V --- 2.53 A

Power Sources

27GS60QC/ 27GS60QX/ 27GS60QN

- Power Rating: 19V --- 2.1 A

32GS60QC/ 32GS60QX

- Power Rating: 19V --- 2.3 A

Dimensions: Monitor Size (Width x Depth x Height) (mm/ inches)

27GS60QC/ 27GS60QX/ 27GS60QN

- With Stand: 604.9 x 226.5 x 450.7 (23.8 x 8.9 x 17.7)
- Without Stand: 604.9 x 95.7 x 363.8 (23.8 x 3.7 x 14.3)

32GS60QC/ 32GS60QX

- With Stand: 699.9 x 226.5 x 508.1 (27.5 x 8.9 x 20)
- Without Stand: 699.9 x 111.9 x 421.2 (27.5 x 4.4 x 16.5)

Weight (kg/ lbs) (Without Packaging)

27GS60QC/ 27GS60QX/ 27GS60QN

- With Stand: 4.8 (10.5)
- Without Stand: 3.5 (7.7)

32GS60QC/ 32GS60QX

- With Stand: 5.9 (13.0)
- Without Stand: 4.6 (10.1)

Support Mode

(Preset Mode, HDMI)

Resolution	Horizontal Frequency (kHz)	Vertical Frequency (Hz)	Polarity (H/V)	Remarks
640 x 480	31.469	59.940	-/-	
800 x 600	37.897	60.317	+/+	
1024 x 768	48.363	60.000	-/-	
1920 x 1080	67.500	60.000	+/+	
2560 x 1440	88.787	59.951	+/-	Recommended Timing: HDMI1.4
2560 x 1440	111.857	74.971	+/-	
2560 x 1440	182.996	119.998	+/-	
2560 x 1440	218.290	143.991	+/-	Recommended Timing: HDMI2.0

(Preset Mode, DisplayPort)

Resolution	Horizontal Frequency (kHz)	Vertical Frequency (Hz)	Polarity (H/V)	Remarks
640 x 480	31.469	59.940	-/-	
800 x 600	37.897	60.317	+/+	
1024 x 768	48.363	60.000	-/-	
1920 x 1080	67.500	60.000	+/+	
2560 x 1440	88.787	59.951	+/-	
2560 x 1440	150.919	99.946	+/-	
2560 x 1440	182.996	119.998	+/-	
2560 x 1440	222.151	143.973	+/-	Recommended Timing: DP1.2
2560 x 1440	264.540	179.959	+/-	Recommended Timing: DP1.4

HDMI Timing (Video)

Resolution	Horizontal Frequency (kHz)	Vertical Frequency (Hz)
480P	31.5	60
720P	45.0	60
1080P	67.5	60
1080P	135.0	120
2160P	135.0	60

TROUBLESHOOTING

Please refer to the list below if you experience any of the following issues during product use. It may not be a malfunction.

Nothing is displayed on the screen.

- Is the monitor's power cord plugged in?
 - Check if the power cord is correctly plugged into the power outlet.
- Is the monitor's adapter plugged in?
 - Make sure to use the adapter that is provided in the product package.
 - If the monitor is in sleep mode (standby mode), move the mouse, or press any key on the keyboard, to switch the display on.
 - Check if the computer is turned on.
- Is the monitor powered on?
 - Check if the input setting is correct. ([Menu] > [Input])
- Is the [The screen is not currently set to the recommended resolution.] message being displayed?
 - This occurs when signals transferred from the PC (graphics card) are out of the recommended horizontal or vertical frequency range of the monitor. Please see the "PRODUCT SPECIFICATION" section of this manual to set the appropriate frequency.
- Is the [No Signal] message being displayed?
 - This is displayed when the signal cable between the PC and the monitor is missing or disconnected. Check the cable and reconnect it.
- Is the [Out of Range] message being displayed?
 - This occurs when signals transferred from the PC (graphics card) are out of the horizontal or vertical frequency range of the monitor. Please see the "PRODUCT SPECIFICATION" section of this manual to set the appropriate frequency.

Do you see an "Unrecognized monitor, Plug and Play (VESA DDC) monitor found" message?

- Have you installed the display driver?
 - Be sure to install the display driver from our web site: <https://www.lg.com>.
 - Make sure to check if the graphics card supports Plug and Play function.

The screen retains an image.

- Does image sticking occur even when the monitor is turned off?
 - Displaying a still image for a prolonged time may cause damage to the screen, resulting in the retention of the image.
 - To extend the lifetime of the monitor, use a screensaver.

Screen display is unstable and shaky. / Images displayed on the monitor leave shadow trails.

- Did you select the appropriate resolution?
 - If the selected resolution is HDMI 1080i 60/50 Hz (interlaced), the screen may be flickering. Change the resolution to 1080p or the recommended resolution.
 - Not setting the graphics card to the recommended (optimal) resolution may result in blurred text, a dimmed screen, a truncated display area or misalignment of the display.
 - The setting methods may be different depending on the computer or operating system, and some resolutions may not be available depending on the performance of the graphics card. If this is the case, contact the manufacturer of the computer or graphics card for assistance.

The display color is abnormal.

- Does the display appear discolored (16 colors)?
 - Set the color to 24 bit (true color) or higher. (The settings may differ depending on the operating system (OS) you use.)
- Does the display color appear unstable or monochrome?
 - Check if the signal cable is connected properly. Reconnect the cable or reinsert the PC's graphics card.
- Are there spots on the screen?
 - When using the monitor, pixilated spots (red, green, blue, white, or black) may appear on the screen. This is normal for an LCD screen. It is not an error, nor is it related to the monitor's performance.

Some features are disabled.

- Are some functions not available when you press the Menu button?
 - The OSD is locked. Disable [OSD Lock] in [General].

No sound from the headphone port.

- Are images displayed without sound?
 - Make sure that the headphone port connections are made properly.
 - Try increasing the volume with the joystick.
 - Set the audio output of the PC to the monitor you are using. (The settings may differ depending on the operating system (OS) you use.)

LICENSE

Each model has different licenses. Visit www.lg.com for more information on the license.



The terms HDMI, HDMI High-Definition Multimedia Interface, HDMI Trade Dress and the HDMI Logos are trademarks or registered trademarks of HDMI Licensing Administrator, Inc.

OPEN SOURCE SOFTWARE NOTICE INFORMATION

To obtain the source code that is contained in this product, under GPL, LGPL, MPL, and other open source licenses that have the obligation to disclose source code, and to access all referred license terms, copyright notices and other relevant documents, please visit <https://opensource.lge.com>.

LG Electronics will also provide open source code to you on CD-ROM for a charge covering the cost of performing such distribution (such as the cost of media, shipping, and handling) upon email request to opensource@lge.com.

This offer is valid to anyone in receipt of this information for a period of three years after our last shipment of this product.

BEEP GUIDE

Menu	Location
Game Adjust	1
Game Adjust - Game Mode - Gamer 1	1 1 1
Game Adjust - Game Mode - Gamer 2	1 1 2
Game Adjust - Game Mode - FPS	1 1 3
Game Adjust - Game Mode - RTS	1 1 4
Game Adjust - Game Mode - Vivid	1 1 5
Game Adjust - Game Mode - Reader	1 1 6
Game Adjust - Game Mode - HDR Effect	1 1 7
Game Adjust - Game Mode - Color Weakness	1 1 8
Game Adjust - FreeSync / Adaptive-Sync	1 2
Game Adjust - FreeSync / Adaptive-Sync - Extended	1 2 1
Game Adjust - FreeSync / Adaptive-Sync - Basic	1 2 2
Game Adjust - FreeSync / Adaptive-Sync - Off	1 2 3
Game Adjust - Black Stabilizer	1 3
Game Adjust - Black Stabilizer	1 3 1 Slider
Game Adjust - Response Time	1 4
Game Adjust - Response Time - Faster	1 4 1
Game Adjust - Response Time - Fast	1 4 2
Game Adjust - Response Time - Normal	1 4 3
Game Adjust - Response Time - Off	1 4 4
Game Adjust - Crosshair	1 5

Menu	Location
Game Adjust - Crosshair - Red Cross	1 5 1
Game Adjust - Crosshair - Green Cross	1 5 2
Game Adjust - Crosshair - Red Dot	1 5 3
Game Adjust - Crosshair - Green Dot	1 5 4
Game Adjust - Crosshair - Off	1 5 5
Game Adjust - FPS Counter	1 6
Game Adjust - FPS Counter - On	1 6 1
Game Adjust - FPS Counter - Off	1 6 2
Game Adjust - Game Reset	1 7
Game Adjust - Game Reset - No	1 7 1
Game Adjust - Game Reset - Yes	1 7 2
Picture Adjust	2
Picture Adjust - Brightness	2 1
Picture Adjust - Brightness	2 1 1 Slider
Picture Adjust - Contrast	2 2
Picture Adjust - Contrast	2 2 1 Slider
Picture Adjust - Sharpness	2 3
Picture Adjust - Sharpness	2 3 1 Slider
Picture Adjust - Gamma	2 4
Picture Adjust - Gamma - Mode 1	2 4 1
Picture Adjust - Gamma - Mode 2	2 4 2
Picture Adjust - Gamma - Mode 3	2 4 3
Picture Adjust - Gamma - Mode 4	2 4 4
Picture Adjust - Color Temp	2 5

Menu	Location
Picture Adjust - Color Temp - Custom	2 5 1
Picture Adjust - Color Temp - Warm	2 5 2
Picture Adjust - Color Temp - Medium	2 5 3
Picture Adjust - Color Temp - Cool	2 5 4
Picture Adjust - Color Temp - Manual	2 5 5
Picture Adjust - Color Temp - Manual	2 5 5 1 Slider
Picture Adjust - R/G/B	2 6
Picture Adjust - R/G/B - Red	2 6 1 Slider
Picture Adjust - R/G/B - Green	2 6 2 Slider
Picture Adjust - R/G/B - Blue	2 6 3 Slider
Picture Adjust - Six Color	2 7
Picture Adjust - Six Color - Red_Hue	2 7 1 Slider
Picture Adjust - Six Color - Red_Saturation	2 7 2 Slider
Picture Adjust - Six Color - Green_Hue	2 7 3 Slider
Picture Adjust - Six Color - Green_Saturation	2 7 4 Slider
Picture Adjust - Six Color - Blue_Hue	2 7 5 Slider
Picture Adjust - Six Color - Blue_Saturation	2 7 6 Slider
Picture Adjust - Six Color - Cyan_Hue	2 7 7 Slider
Picture Adjust - Six Color - Cyan_Saturation	2 7 8 Slider
Picture Adjust - Six Color - Magenta_Hue	2 7 9 Slider
Picture Adjust - Six Color - Magenta_Saturation	2 7 10 Slider
Picture Adjust - Six Color - Yellow_Hue	2 7 11 Slider
Picture Adjust - Six Color - Yellow_Saturation	2 7 12 Slider
Picture Adjust - Black Level	2 8

Menu	Location
Picture Adjust - Black Level - High	2 8 1
Picture Adjust - Black Level - Low	2 8 2
Picture Adjust - Picture Reset	2 9
Picture Adjust - Picture Reset - No	2 9 1
Picture Adjust - Picture Reset - Yes	2 9 2
Input	3
Input - Input List	3 1
Input - Input List - HDMI	3 1 1
Input - Input List - DisplayPort	3 1 2
Input - Aspect Ratio	3 2
Input - Aspect Ratio - Full Wide	3 2 1
Input - Aspect Ratio - Original	3 2 2
Input - Auto Input Switch	3 3
Input - Auto Input Switch - On	3 3 1
Input - Auto Input Switch - Off	3 3 2
General	4
General - Language	4 1
General - Language - English	4 1 1
General - Language - German	4 1 2
General - Language - French	4 1 3
General - Language - Spanish	4 1 4
General - Language - Italian	4 1 5
General - Language - Swedish	4 1 6
General - Language - Finnish	4 1 7

Menu	Location
General - Language - Portuguese	4 1 8
General - Language - Portuguese (Brazil)	4 1 9
General - Language - Polish	4 1 10
General - Language - Russian	4 1 11
General - Language - Turkish	4 1 12
General - Language - Ukrainian	4 1 13
General - Language - Chinese	4 1 14
General - Language - Traditional Chinese	4 1 15
General - Language - Japanese	4 1 16
General - Language - Korean	4 1 17
General - User-defined Key 1	4 2
General - User-defined Key 1 - Input	4 2 1
General - User-defined Key 1 - Game Mode	4 2 2
General - User-defined Key 1 - Crosshair	4 2 3
General - User-defined Key 1 - Black Stabilizer	4 2 4
General - User-defined Key 1 - Response Time	4 2 5
General - User-defined Key 1 - FPS Counter	4 2 6
General - User-defined Key 2	4 3
General - User-defined Key 2 - Input	4 3 1
General - User-defined Key 2 - Game Mode	4 3 2
General - User-defined Key 2 - Crosshair	4 3 3
General - User-defined Key 2 - Black Stabilizer	4 3 4
General - User-defined Key 2 - Response Time	4 3 5
General - User-defined Key 2 - FPS Counter	4 3 6

Menu	Location
General - SMART ENERGY SAVING	4 4
General - SMART ENERGY SAVING - High	4 4 1
General - SMART ENERGY SAVING - Low	4 4 2
General - SMART ENERGY SAVING - Off	4 4 3
General - Deep Sleep Mode	4 5
General - Deep Sleep Mode - On	4 5 1
General - Deep Sleep Mode - Off	4 5 2
General - Automatic Standby	4 6
General - Automatic Standby - 8H	4 6 1
General - Automatic Standby - 6H	4 6 2
General - Automatic Standby - 4H	4 6 3
General - Automatic Standby - Off	4 6 4
General - Input Compatibility Version	4 7
General - Input Compatibility Version(HDMI) - 2.0	4 7 1
General - Input Compatibility Version(HDMI) - 1.4	4 7 2
General - Input Compatibility Version(Displayport) - 1.4	4 7 1
General - Input Compatibility Version(Displayport) - 1.2	4 7 2
General - Buzzer	4 8
General - Buzzer - On	4 8 1
General - Buzzer - Off	4 8 2
General - OSD Lock	4 9
General - OSD Lock - On	4 9 1
General - OSD Lock - Off	4 9 2

Menu	Location
General - Information	4 10
General - Open Source Software License	4 11
General - Open Source Software License - View	4 11 1
General - Reset to Initial Settings	4 12
General - Reset to Initial Settings - No	4 12 1
General - Reset to Initial Settings - Yes	4 12 2



The model and serial number of the product are located on the back and on one side of the product.

Record them below in case you ever need service.

Model

Serial No.

Supplier's Declaration of Conformity

Trade Name	LG
Responsible Party	LG Electronics USA, Inc.
Address	111 Sylvan Avenue, North Building, Englewood Cliffs, NJ 07632
E-mail	lg.environmental@lge.com

IMPORTANT PRECAUTIONS

Please read these safety precautions carefully before using the product. All precautions and safety information applies to LCD and OLED models.

WARNING

Failure to follow those warnings may result in death, serious injury or damage to the product or other property.

Precautions to the AC Adapter and Electrical Power

WARNING

- **If water or any foreign substance goes inside the product (TV, monitor, power cord, or AC adapter), disconnect the power cord immediately and contact the service center.**
 - » Otherwise, this may cause a fire or electric shock due to damage to the product.
- **Do not touch the power plug or AC adapter with wet hands. If the pins of the plug are wet or dusty, wipe and dry them before use.**
 - » Otherwise, this may cause a fire or electric shock.
- **Make sure to completely insert the power cord into the AC adapter.**
 - » If loosely connected, the poor connection may cause a fire or electric shock.
- **Be sure to use power cords and AC adapters provided or approved by LG Electronics, Inc.**
 - » The use of non-approved products may cause a fire or electric shock.
- **When unplugging the power cord, always pull it by the plug. Do not bend the power cord with excessive force.**
 - » The power line can be damaged, which may cause electric shock or fire.
- **Be careful not to step or place heavy objects (electronic appliances, clothing, etc.) on the power cord or AC adapter. Be careful not to damage the power cord or AC adapter with sharp objects.**
 - » Damaged power cords may cause a fire or electric shock.
- **Never disassemble, repair or modify the power cord or AC adapter.**
 - » This may cause a fire or electric shock.
- **Use only the power cord supplied with the unit or another manufacturer's authorized cord.**
 - » Failure to do so may result in fire or electrical shock or damage to the product.
- **Use only a properly grounded plug and receptacle.**
 - » If you do not you may be electrocuted or injured. Or the product might be damaged.
- **Do not use a damaged or loose plug.**
 - » This may cause electrical shock or fire.
- **Operate the display only from a power source (i.e. voltage) indicated in the product specification.**
 - » Otherwise the product can be damaged, fire can occur or you may be electrocuted. If you are not sure what type of power supply you have, consult a certified electrician.
- **In the presence of thunder and lightning, never touch the power cord and signal cable because it can be very dangerous.**
 - » It can cause electric shock.
- **Do not connect several extension cords, electrical appliances or electrical heaters to a single outlet. Use a power bar with a grounding terminal designed for exclusive use with the computer.**
 - » A fire can break out due to overheating.
- **Do not touch the power plug with wet hands. Additionally, if the cord pin is wet or covered with dust, dry the power plug completely or wipe dust off before plugging in the cord.**
 - » You may be electrocuted due to excess moisture.
- **If you don't intend to use the product for a long time, unplug the power cable from the product.**
 - » Covering dust can cause a fire, or insulation deterioration can cause electric leakage, electric shock or fire.
- **Insert the power plug firm so it cannot come loose.**
 - » A loose connection can cause fire.

- **Do not insert metal or other conductive materials into the product openings. Additionally, do not touch the power cable right after plugging into the wall input terminal.**
 - » You may be electrocuted.
- **The AC Plug is the disconnecting device. It should be easily accessible in case of emergency.**
- **Please make sure the device is installed near the wall outlet to which it is connected and that the outlet is easily accessible.**
- **Be sure to keep the outlet, AC adapter, and pins of the power plug clean from dust and etc.**
 - » This may cause a fire.
- **Do not unplug the power cord while the product is in use.**
 - » Electrical shock can damage the product.
- **As long as this unit is connected to the AC wall outlet, it is not disconnected from the AC power source even if the unit is turned off.**

Precautions in installing the Product

WARNING

- **Keep away from heat sources like heaters or open flames.**
 - » Electrical shock, fire, malfunction or deformation may occur.
- **Keep the packing anti-moisture material or vinyl packing out of the reach of children.**
 - » Anti-moisture material is harmful if swallowed. If swallowed by mistake, force the patient to vomit and visit the nearest hospital. Additionally, vinyl packing can cause suffocation. Keep it out of the reach of children.
- **Do not put heavy objects on the product on sit upon it.**
 - » If the product collapses or is dropped, you may be injured. Children must pay particular attention.
- **Do not leave the power or signal cable where someone can trip over it.**
 - » The passerby can falter, which can cause electrical shock, fire, product breakdown or injury.
- **Install the product in a neat and dry place. Do not use near water.**
 - » Dust or moisture can cause electrical shock, fire or product damage.
- **Do not add accessories that have not been designed for this display.**
- **If you smell smoke or other odors or hear a strange sound from the product unplug the power cord and contact LG Customer Service.**
 - » If you continue to use without taking proper measures, electrical shock or fire can occur.
- **If you dropped the product or the case is broken, turn off the product and unplug the power cord.**
 - » If you continue to use without taking proper measures, electrical shock or fire can occur. Contact LG Customer Service.
- **Do not drop an object on or apply impact to the product. Do not throw any toys or objects at the product.**
 - » It can cause injury to humans, problems to the product and damage the display.
- **Keep out of reach of children and do not place toys near the product.**
- **Make sure the product ventilation hole is not blocked. Install the product more than 10cm from the wall.**
 - » If you install the product too close to the wall, it may be deformed or fire can break out due to internal heat build-up.
- **Do not cover the product with cloth or other material (eg. plastic) while plugged in.**
 - » The product can be deformed or fire can break out due to internal overheating.
- **Place the product on a flat and stable surface that is large enough to support the product.**
 - » If the product is dropped, you may be injured or the product may be broken.
- **Install the product where no Electromagnetic Interference occurs.**
- **Keep the product away from direct sunlight.**
 - » The product can be damaged.
- **Do not place the product on the floor.**
 - » Small Children and others may trip over it.
- **Do not install this product on a wall if it could be exposed to oil or oil mist.**
 - » This may damage the product and cause it to fall.
- **For displays with glossy bezels the user should consider the placement of the display as the bezel may cause disturbing reflections from surrounding light and bright surfaces.**

Precautions in Moving the Product

⚠ WARNING

- **Make sure to turn off the product.**
 - » You may be electrocuted or the product can be damaged.
- **Make sure to remove all cables before moving the product.**
 - » You may be electrocuted or the product can be damaged.
- **When lifting or moving the product, do not hold it upside down while holding only the stand.**
 - » This may cause the product to fall resulting in damage or injury.
- **Do not shock the product when moving it.**
 - » You may be electrocuted or the product can be damaged.
- **Make sure the panel faces forward and hold it with both hands to move.**
 - » If you drop the product, the damaged product can cause electric shock or fire.
- **Do not place the product face down.**
 - » This may damage the TFT-LCD screen.

Precautions in Using/Cleaning the Product

⚠ WARNING

- **Do not attempt to disassemble, repair or modify the product yourself.**
 - » Fire or electric shock can occur.
 - » Contact LG Customer Service for repair.
- **When cleaning the product, unplug the power cord and scrub gently with a soft cloth to prevent scratching. Do not clean with a wet cloth or spray water or other liquids directly onto the product. An electric shock may occur. (Do not use chemicals such as benzene, paint thinners or alcohol)**
- **Keep the product away from water.**
 - » Fire or electric shock accident can occur.
- **Avoid high temperatures and humidity.**
- **Do not put or store flammable substances near the product.**
 - » There is a danger of explosion or fire.
- **Keep the product clean at all times.**
- **Take a comfortable and natural position when working with the product.**
- **Take a regular break when working with the product for a long time.**
- **Do not press on the panel with a hand or sharp object such as nail, pencil or pen, or make a scratch on it.**
- **Keep proper distance from the product and rest from time-to-time.**
 - » Your vision may be impaired if you look at the product too closely or for too long.
- **Set the appropriate resolution by referring to the User's Guide.**
- **Keep small accessories out of the reach of children.**
- **Displaying a still image for long time on the monitor may leave persistent image or stain on the monitor screen. To avoid this problem, use a screen saver and power off when this product is not used. Persistent image or stain caused by long time usage are not covered by the warranty on this product.**
- **Do not use products using high voltage around the Monitor. (ex. Electrical Swatter)**
 - » Monitor may have malfunction as its electrical shock.
- **Spray water onto a soft cloth 2 to 4 times, and use it to clean the front frame; wipe in one direction only. Too much moisture may cause staining.**

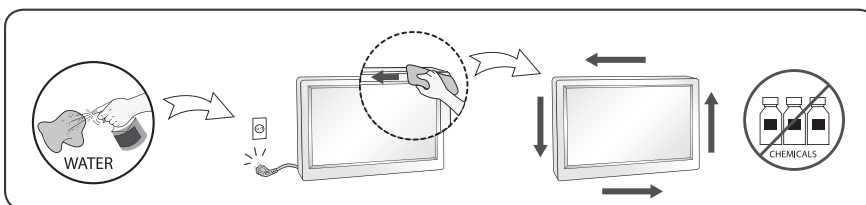

PRÉCAUTIONS IMPORTANTES

Veuillez lire avec attention ces mesures de sécurité avant d'utiliser le produit. Toutes les précautions et tous les renseignements de sécurité s'appliquent aux modèles ACL et OLED.



AVERTISSEMENT

Le non-respect de ces avertissements pourrait entraîner la mort, des blessures graves ou endommager le produit ou d'autres biens.

Précautions à prendre avec l'adaptateur c.a. et l'alimentation électrique



AVERTISSEMENTS

- **Si de l'eau ou toute autre substance étrangère pénètre dans l'appareil (téléviseur, moniteur, cordon d'alimentation ou adaptateur c.a.), débranchez immédiatement le cordon d'alimentation, puis communiquez avec le centre de service.**
 - » Cela pourrait entraîner un incendie ou une décharge électrique en raison des dommages causés à l'appareil.
- **Ne touchez pas la prise d'alimentation ou l'adaptateur c.a. si vous avez les mains mouillées. Si les broches de la fiche sont humides ou poussiéreuses, essuyez-les et asséchez-les avant d'utiliser l'appareil.**
 - » Cela pourrait entraîner un incendie ou une décharge électrique.
- **Assurez-vous d'enfoncer complètement la fiche du cordon dans l'adaptateur c.a.**
 - » Un branchement desserré pourrait causer un incendie ou une décharge électrique.
- **Assurez-vous d'utiliser les cordons d'alimentation et adaptateurs c.a. fournis ou approuvés par LG Electronics, Inc.**
 - » L'utilisation de produits non approuvés pourrait entraîner un incendie ou une décharge électrique.
- **Lorsque vous débranchez le cordon d'alimentation, tirez-le toujours par la fiche. Ne pliez pas le cordon d'alimentation avec une force excessive.**
 - » Le cordon d'alimentation peut être endommagé, ce qui pourrait causer une décharge électrique ou un incendie.
- **Assurez-vous de ne pas marcher sur le cordon d'alimentation ou sur l'adaptateur c.a. ni d'y poser d'objets lourds (appareils électroniques, vêtements, etc.). Prenez soin de ne pas endommager le cordon d'alimentation ou l'adaptateur c.a. avec des objets tranchants.**
 - » Un cordon d'alimentation endommagé pourrait causer un incendie ou une décharge électrique.
- **Ne désassemblez, ne réparez ou ne modifiez jamais le cordon d'alimentation ou l'adaptateur c.a.**
 - » Cela pourrait causer un incendie ou une décharge électrique.
- **Utilisez uniquement le cordon d'alimentation fourni avec le moniteur ou tout autre cordon approuvé par le fabricant.**
 - » Le non-respect de cette directive peut entraîner un incendie, une décharge électrique ou endommager l'appareil.
- **Utilisez uniquement des prises et des fiches correctement mises à la terre.**
 - » Dans le cas contraire, vous pourriez vous électrocuter ou vous blesser. L'appareil pourrait également être endommagé.
- **N'utilisez pas une prise endommagée ou desserrée.**
 - » Cela pourrait causer une décharge électrique ou un incendie.
- **Utilisez l'écran uniquement avec une source d'alimentation (tension) conforme aux caractéristiques indiquées.**
 - » Dans le cas contraire, l'appareil pourrait être endommagé, un incendie pourrait se produire ou vous pourriez recevoir une décharge électrique. Si vous n'êtes pas certain du type d'alimentation dont vous disposez, consultez un électricien qualifié.
- **En présence de tonnerre et d'éclairs, il est très dangereux de toucher le cordon d'alimentation ou les câbles de signaux.**
 - » Cela pourrait causer une décharge électrique.
- **Ne branchez pas plusieurs cordons d'alimentation, appareils électriques et radiateurs électriques à une seule prise murale. Utilisez un bloc d'alimentation muni d'une broche de mise à la terre, conçu exclusivement pour être utilisé avec du matériel informatique.**
 - » Un incendie pourrait se déclencher par surchauffe.
- **Ne touchez pas le cordon d'alimentation si vous avez les mains mouillées. En outre, si les broches de la fiche sont mouillées ou recouvertes de poussière, essuyez complètement la fiche ou essuyez la poussière avant de la brancher.**
 - » Vous pourriez recevoir une décharge électrique en raison de l'excès d'humidité.
- **Si vous ne prévoyez pas utiliser l'appareil pendant une longue période, débranchez le cordon d'alimentation.**
 - » L'accumulation de poussière peut causer un incendie, et la dégradation de l'isolation peut entraîner une fuite électrique, une décharge électrique ou un incendie.
- **Insérez fermement la fiche afin qu'elle ne soit pas lâche.**

- » Un branchement desserré peut provoquer un incendie.
- **N'introduisez pas de métal ni tout autre matériau conducteur dans les ouvertures du moniteur. En outre, ne touchez pas le câble d'alimentation immédiatement après l'avoir branché dans la prise murale.**
 - » Vous pourriez recevoir une décharge électrique.
- **La fiche c.a. est utilisée comme dispositif de déconnexion. Elle devrait être facilement accessible en cas d'urgence.**
- **Assurez-vous que l'appareil est installé à proximité de la prise de courant murale sur laquelle l'appareil est branché et que la prise de courant est facilement accessible.**
- **Assurez-vous de garder la prise de courant, l'adaptateur c.a. et les broches du cordon d'alimentation exempts de poussière ou autre substance étrangère.**
 - » Cela pourrait provoquer un incendie.
- **Ne débranchez pas le cordon d'alimentation lorsque l'appareil est en cours de fonctionnement.**
 - » Une décharge électrique pourrait endommager l'appareil.
- **Tant que cet appareil est relié à la prise d'alimentation murale, il n'est pas déconnecté de la source de courant alternatif même si l'appareil est éteint.**

Précautions lors de l'installation de l'appareil

AVERTISSEMENTS

- **Éloignez le moniteur des sources de chaleur comme les radiateurs et les flammes nues.**
 - » Cela pourrait entraîner une décharge électrique, un incendie, un mauvais fonctionnement ou une déformation de l'appareil.
- **Gardez le sachet anti-humidité et l'emballage de vinyle hors de la portée des enfants.**
 - » Le sachet anti-humidité est dangereux en cas d'ingestion. En cas d'ingestion, forcez la personne à vomir et rendez-vous à l'hôpital le plus proche. De plus, l'emballage de vinyle peut entraîner la suffocation. Maintenez-le hors de la portée des enfants.
- **Ne posez pas d'objets lourds sur l'appareil, et ne vous asseyez pas dessus.**
 - » Si l'appareil tombe ou s'il est échappé, vous pourriez vous blesser. Les enfants doivent être particulièrement attentifs.
- **Ne laissez pas le câble d'alimentation ou de signal à un endroit où quelqu'un risquerait de trébucher dessus.**
 - » Le passant pourrait trébucher, ce qui pourrait entraîner un risque de décharge électrique, d'incendie, de panne de l'appareil ou de blessure.
- **Installez l'appareil dans un endroit propre et sec. Ne l'utilisez pas près d'une source d'eau.**
 - » La poussière et l'humidité peuvent causer une décharge électrique, un incendie ou endommager l'appareil.
- **N'ajoutez pas d'accessoires qui n'ont pas été conçus pour ce moniteur.**
- **Si une odeur de fumée ou toute autre odeur se dégage du moniteur ou si vous entendez un son étrange en provenance du moniteur, débranchez le cordon d'alimentation et contactez le service à la clientèle de LG.**
 - » Si vous continuez à utiliser l'appareil sans prendre de mesures appropriées, il y a un risque de décharge électrique ou d'incendie.
- **Si vous avez fait tomber l'appareil ou si le boîtier est cassé, éteignez l'appareil et débranchez le cordon d'alimentation.**
 - » Si vous continuez de l'utiliser sans prendre les mesures appropriées, cela risque de provoquer une décharge électrique ou un incendie. Contactez le service à la clientèle de LG.
- **Ne faites pas tomber d'objets sur l'appareil et n'exercez pas d'impact sur celui-ci. Ne lancez aucun jouet ni autre objet vers l'appareil.**
 - » Cela peut entraîner des blessures corporelles, nuire au fonctionnement de l'appareil et endommager l'écran.
- **Maintenez-le hors de la portée des enfants et ne placez aucun jouet à proximité.**
- **Assurez-vous que les sorties de ventilation de l'appareil ne sont pas obstruées. Installez l'appareil à plus de 10 cm du mur.**
 - » Si vous installez l'appareil trop près du mur, cela pourrait le déformer ou un incendie pourrait se déclencher en raison d'une surchauffe interne.
- **Ne couvrez pas l'appareil avec des tissus ou d'autres matériaux (plastique par exemple) lorsqu'il est branché.**
 - » Cela pourrait déformer le moniteur ou un incendie pourrait se déclencher en raison d'une surchauffe interne.
- **Placez l'appareil sur une surface plane et stable, suffisamment large pour le supporter.**
 - » Si l'appareil tombe, vous pourriez vous blesser, ou cela pourrait l'endommager.
- **Installez l'appareil dans un endroit exempt d'interférences électromagnétiques.**
- **Éloignez l'appareil des rayons directs du soleil.**
 - » L'appareil pourrait être endommagé.
- **Ne placez pas l'appareil sur le sol.**
 - » Des jeunes enfants ou d'autres personnes pourraient trébucher.
- **N'installez pas l'appareil sur un mur où il est susceptible d'être exposé à de l'huile ou à de la vapeur d'huile.**
 - » Cela pourrait endommager l'appareil et provoquer sa chute.
- **Pour les écrans munis d'un cadre brillant, lors de l'installation, l'utilisateur doit tenir compte de l'emplacement de l'écran, car le cadre pourrait créer des reflets gênants en raison de la lumière environnante ou de surfaces brillantes situées à proximité.**

Précautions concernant le déplacement de l'appareil

⚠ AVERTISSEMENTS

- **Assurez-vous d'éteindre l'appareil.**
 - » Vous pourriez recevoir une décharge électrique ou endommager l'appareil.
- **Assurez-vous de retirer tous les câbles avant de déplacer l'appareil.**
 - » Vous pourriez recevoir une décharge électrique ou endommager l'appareil.
- **Lorsque vous soulevez ou déplacez l'appareil, ne le tenez pas à l'envers uniquement par le support.**
 - » L'appareil pourrait tomber et entraîner des dommages ou des blessures.
- **Ne cognez pas l'appareil lors de son déplacement.**
 - » Vous pourriez recevoir une décharge électrique ou endommager l'appareil.
- **Assurez-vous que le panneau est tourné vers l'avant et que vous le tenez avec les deux mains.**
 - » Si vous faites tomber l'appareil, l'appareil endommagé peut entraîner une décharge électrique ou un incendie.
- **Ne placez pas l'appareil face vers le bas.**
 - » Cela pourrait endommager l'écran à cristaux liquides TFT.

Précautions lors de l'utilisation et du nettoyage de l'appareil

⚠ AVERTISSEMENTS

- **Ne tentez pas de désassembler, de réparer ou de modifier l'appareil vous-même.**
 - » Il existe un risque d'incendie ou de décharge électrique.
 - » Contactez le service à la clientèle de LG pour le faire réparer.
- **Pour nettoyer l'appareil, débranchez le cordon d'alimentation et frottez doucement avec un chiffon doux pour prévenir toute éraflure. Ne nettoyez pas avec un chiffon humide et ne pulvérisez ni eau ni autres liquides directement sur l'appareil. Une décharge électrique peut se produire. (N'employez pas de produits chimiques tels que le benzène, les diluants pour peinture ou l'alcool.)**
- **Éloignez l'appareil de toute source d'eau.**
 - » Il existe un risque d'incendie ou de décharge électrique.
- **Évitez l'humidité et les températures élevées.**
- **Ne placez pas et n'entrez pas de substances inflammables à proximité de l'appareil.**
 - » Il existe un danger d'explosion ou d'incendie.
- **Maintenez l'appareil propre en tout temps.**
- **Adoptez une position confortable et naturelle lorsque vous êtes assis devant le moniteur.**
- **Prenez régulièrement une pause lorsque vous utilisez le moniteur pendant une période prolongée.**
- **N'appuyez pas sur le panneau avec la main ou un objet pointu, comme un ongle, un stylo ou un crayon, et ne le rayez pas.**
- **Maintenez une distance adéquate avec l'appareil et reposez-vous de temps en temps.**
 - » Votre vision pourrait être affaiblie si vous regardez le moniteur de trop près ou trop longtemps.
- **Réglez la résolution appropriée en vous reportant au manuel d'utilisation.**
- **Conservez les petits accessoires hors de la portée des enfants.**
- **L'affichage d'une image fixe pendant une durée prolongée peut provoquer l'apparition d'une image persistante ou d'une tache. Pour éviter ce problème, définissez un écran de veille et éteignez l'écran lorsque vous n'utilisez pas l'appareil. La garantie de l'appareil ne couvre pas les images persistantes ni les taches attribuables à un affichage fixe prolongé.**
- **N'utilisez pas d'appareils à haute tension (comme un tueur-mouches électrique) à proximité du moniteur.**
 - » Une décharge électrique pourrait endommager le moniteur.
- **Vaporisez de l'eau sur un chiffon doux de 2 à 4 fois, puis utilisez-le pour nettoyer le cadre. Essayez toujours dans le même sens. Si le chiffon est trop humide, des taches risquent d'apparaître sur le moniteur.**

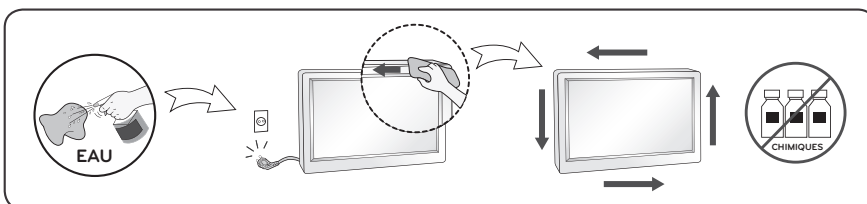

ENGLISH

DDC (Display Data Channel)

DDC is a communication channel over which the monitor automatically informs the host system (PC) about its capabilities.

DDC protocol

- ① DDC1/DDC2B
An uni-directional communication channel.
- ② DDC 2AB/DDC2B+/DDC2Bi
A bi-directional communication channel.

Note

- *PC must support DDC functions to do this.*

E-DDC (Enhanced DDC)

A protocol based on I²C and used on a bi-directional data channel between the display and host. This protocol accesses devices at I²C address of A0/A1 as well as the address 60. The 60 address is used as a segment register to allow larger amounts of data to be retrieved than is possible using DDC2B protocols. The protocol is compatible with DDC2B protocols.

DEUTSCH

DDC (Display Data Channel)

DDC ist ein Kommunikationskanal, über welche Sie von Ihrem Monitor automatisch über das verbundene System (PC) und seine Fähigkeiten informiert werden.

DDC Protokoll

- ① DDC1/DDC2B
Ein unidirektionaler Kommunikationskanal.
- ② DDC 2AB/DDC2B+/DDC2Bi
Ein bidirektionaler Kommunikationskanal.

Anmerkung

- *Der PC muß für DDC Funktionen eingerichtet sein.*

E-DDC (Erweitertes DDC)

Ein Protokoll, das auf I²C basiert und in einem bidirektionalen Datenkanal zwischen Anzeige und Host eingesetzt wird. Dieses Protokoll greift an der I²C-Adresse von A0/A1 und an der Adresse 60 auf Geräte zu. Die Adresse 60 dient als Segmentregister und ermöglicht den Abruf von größeren Datenmengen als mit den DDC2B-Protokollen. Das Protokoll ist mit den DDC2B-Protokollen kompatibel.

FRANÇAIS

DDC (Display Data Channel)

DDC est une chaîne de communication par le biais de laquelle le moniteur prévient automatiquement le système central (PC) de ces capacités.

Protocole DDC

- ① DDC1/DDC2B
Canal de communication unidirectionnel.
- ② DDC 2AB/DDC2B+/DDC2Bi
Canal de communication bidirectionnel.

Remarque

- *Le PC doit posséder les fonctions DDC pour cela.*

E-DDC (Commande numérique directe (DDC) optimisée)

Protocole fondé sur l'I²C et appliqué à un canal bi-directionnel de transmission de données placé entre l'écran et l'hôte. Ce protocole accède aux périphériques à l'adresse I²C de A0/A1 ainsi qu'à l'adresse 60. L'adresse 60 est utilisée comme registre de segment afin d'obtenir des quantités de données supérieures à ce que permettent les protocoles DDC2B. Ce protocole est compatible avec les protocoles DDC2B.

ITALIANO

DDC (Display Data Channel)

Il DDC è un canale di comunicazione attraverso il quale il monitor informa automaticamente il sistema ospite (PC) circa le proprie capacità.

Protocollo DDC

- ① DDC1/DDC2B
Un canale di comunicazione uni-direzionale.
- ② DDC 2AB/DDC2B+/DDC2Bi
Un canale di comunicazione bi-direzionale.

Nota

- *Per fare questo il PC deve supportare le funzioni DDC.*

E-DDC (DDC potenziato)

Protocollo basato su I²C e utilizzato su un canale dati bidirezionale tra monitor e host. Questo protocollo accede a dispositivi con indirizzo I²C di A0/A1 nonché all'indirizzo 60. L'indirizzo 60 viene utilizzato come registro di segmento per consentire di recuperare quantità di dati superiori rispetto a quanto è possibile utilizzando i protocolli DDC2B. Il protocollo è compatibile con i protocolli DDC2B.

ESPAÑOL

DDC (Canal de despliegue de información)

DDC es un canal de comunicación sobre el cual el monitor automáticamente informa al sistema anfitrión (PC) sobre sus capacidades.

Protocolo DDC

① DDC1/DDC2B

Un canal de comunicación unidireccional.

② DDC 2AB/DDC2B+/DDC2Bi

Un canal de comunicación bidireccional.

Nota

- *La PC debe soportar las funciones DDC para poder hacer esto.*

PORTUGUÊS

DDC (Display Data Channel)

DDC é um canal de comunicação através do qual o monitor informa ao computador a respeito de suas características.DDC

Protokoll

① DDC1/DDC2B

Um canal de comunicação unidireccional.

② DDC 2AB/DDC2B+/DDC2Bi

Um canal de comunicação bidireccional.

Ovservação

- *O PC deve suportar DDC para fazer isso.*

E-DDC (DDC mejorado)

Un protocolo que se basa en I²C y se usa en un canal de datos bidireccional entre el monitor y el sistema host. Este protocolo accede a los dispositivos en la direccion I²C de A0/A1, asi como en la direccion 60. La direccion 60 se usa como un registro de segmentos para poder recuperar mas cantidad de datos de lo que es posible mediante los protocolos DDC2B. El protocolo es compatible con protocolos DDC2B.

E-DDC (DDC Aperfeicoado)

Um protocolo com base em I²C que e utilizado em um canal de dados bidireccional entre o monitor e o host. Este protocolo acessa dispositivos no endereco I²C do A0/A1 assim como no endereco 60. O endereco 60 e utilizado com um registro de segmento que permite que maiores quantidades de dados sejam recuperados que quando se utiliza os protocolos DDC2B. O protocolo e compativel com os protocolos DDC2B.

NEDERLANDS

DDC (Display Data Channel)

DDC is een communicatiekanaal waarmee de monitor het hostsysteem (PC) automatisch informeert over zijn mogelijkheden.

DDC-protocol

- ① DDC1/DDC2B
Een unidirectioneel communicatiekanaal.
- ② DDC 2AB/DDC2B+/DDC2Bi
Een bidirectioneel communicatiekanaal.

OPMERKING

- *Dit kan alleen als de PC DDC ondersteunt.*

E-DDC (Uitgebreide DDC)

Een op I²C gebaseerd protocol dat wordt gebruikt op een gegevenskanaal in twee richtingen, tussen het scherm en de host. Dit protocol geeft toegang tot apparatuur met A0/A1 en 60 als I²C-adres. Het adres 60 wordt gebruikt als een segmentregister waarmee in vergelijking met DDC2B-protocollen grotere hoeveelheden gegevens kunnen worden gezocht. Het protocol is compatible met DDC2B-protocollen.

РУССКИЙ

Канал обмена данных между монитором и компьютером DDC.

DDC-канал связи, по которому монитор автоматически информирует компьютер о своих возможностях.

Протокол DDC

- ① DDC1/DDC2B
Односторонний канал связи
- ② DDC 2AB/DDC2B+/DDC2Bi
Двусторонний канал связи.

ПРИМЕЧАНИЕ

- *Примечание: Для работы в этом режиме необходимо загрузить соответствующий драйвер компьютера.*

E-DDC (Расширенный канал передачи данных)

Протокол, основанный на технологии I²C, который используется для двусторонней передачи данных между дисплеем и источником видеоданных. Для доступа к устройствам используются биты адреса I²C (A0/A1), а также адрес 60. Адрес 60 указывает на регистр сегментов, который позволяет получать большие объемы данных, чем при использовании протокола DDC2B. Этот протокол совместим с протоколами DDC2B.

한국어

DDC(디스플레이 데이터 채널)

DDC 는 모니터의 기능에 관한 정보를 자동으로 호스트 시스템 (PC) 에 제공하는 통신 채널입니다

DDC protocol

- ① DDC1/DDC2B
단방향 통신 채널 channel.
- ② DDC 2AB/DDC2B+/DDC2Bi
양방향 통신 채널.

주

- PC 가 DDC 기능을 지원해야 합니다.

日本語

DDC(ディスプレイ・データ・チャンネル)

DDC は、モニターがその状態をホスト・システム(PC)へ自動的に通知する通信チャンネルです。

DDC プロトコル

- ① DDC1/DDC2B
一方向通信チャンネル。
- ② DDC 2AB/DDC2B+/DDC2Bi
双方向通信チャンネル。

注

- このためにはPCがDDC機能をサポートしなければなりません。

E-DDC(확장 DDC)

I²C 에 기반을 둔 프로토콜로써 디스플레이와 호스트간의 양방향 데이터 채널 상에서 사용됩니다. 이 프로토콜은 A0/A1 의 I²C 주소 및 주소 60 을 통해 장치에 액세스합니다. 주소 60 은 세그먼트 레지스터로 사용되어 DDC2B 프로토콜을 사용한 것보다 더 큰 용량의 데이터 검색을 가능하게 합니다. 이 프로토콜은 DDC2B 와 호환됩니다.

E-DDC(Enhanced Display Data Channel)

I²C 베이스 프로토콜로써, 디스플레이와 호스트간의 양방향 데이터 채널에 사용하는 프로토콜. 이 프로토콜을 사용하여, 60 이라는 주소와 동일하게, A0/A1 이라는 I²C 주소의 장치에 액세스합니다.

60 이라는 주소를 세그먼트 레지스터로 사용すると, DDC2B 프로토콜을 사용하는よりも, 大容量의 데이터를取り出すことができます. 이 프로토콜は DDC 2B 프로토콜と互換性があります.

العربية

DDC (قناة بيانات الشاشة)

DDC هي قناة تواصل تُعلم الشاشة من خلالها النظام المضيف (الكمبيوتر) تلقائياً حول قدراتها.

بروتوكول DDC

① DDC²B/DDC¹

قناة تواصل أحادية الاتجاه.

② DDC²AB/DDC²B+/DDC²Bi

قناة تواصل ثنائية الاتجاه.

ملاحظة

يجب أن يعتمد الكمبيوتر وظائف DDC للقيام بذلك.

E-DDC (DDC معززة)

يستند البروتوكول إلى I²C ويُستخدم على قناة بيانات ثنائية الاتجاه بين الشاشة والجهاز المضيف. يصل هذا البروتوكول إلى الأجهزة على عنوان I²C الخاص بـ A¹/A⁰ بالإضافة إلى العنوان 60. يُستخدم العنوان 60 كسجل مقطع للسماح باسترداد كميات كبيرة من البيانات تفوق الكميات الممكنة باستخدام بروتوكولات DDC²B. البروتوكول متوافق مع بروتوكولات DDC²B.

ENGLISH

Energy Saving Design

This program is designed to have computer equipment manufacturers build circuitry into their products to reduce power consumption when it is not in operation.

When this monitor is used with a PC on which a screen blanking software complying with the VESA Display Power Management Signalling (DPMS) Protocol is installed, it can conserve significant energy by reducing power consumption when it is not in operation.

There are 2 signal lines, 3 modes of operation.
: On Mode, Sleep Mode, Off Mode.

Mode	Definition
On mode	The normal operation. When the monitor is on mode, being connected to a power source, it displays an image.
Sleep Mode	The reduced power state. returns to on mode when the user moves the mouse or presses a key on the keyboard.
Off Mode	The lowest power consumption state. returns to on mode when the user pushes a power switch.

Note

- *The energy saving Design monitors only work while connected to the computers that have energy saving features.*

PORTUGUÊS

Programa de economia de energia

Este programa foi elaborado com a finalidade de estimular os fabricantes de equipamentos para computadores a construírem em seus produtos sistemas que reduzam o consumo de energia quando eles não estiverem em uso.

Quando este monitor for utilizado com um computador cujo software de proteção de tela estiver instalado, em conformidade com o protocolo de gerenciamento de energia Display Power Management Signalling (DPMS) VESA, pode haver uma considerável economia de energia pela redução do consumo elétrico em momentos de ociosidade.

Existem duas linhas de sinal e três modos de operação: Ativado (On), em espera (Sleep) e desativado (Off).

Modo	Definição
Ligado	A operação normal. Quando o monitor estiver ativado e conectado a uma fonte de alimentação, será exibida uma imagem.
Em espera	Estado de baixa energia. Retorna ao modo ativado quando o usuário move o mouse ou pressiona uma tecla no teclado.
Desativado	O estado de menor consumo de energia. Retorna ao modo ativado quando o usuário pressiona algum botão liga/desliga.

Observação

- *Os monitores que incorporam o programa de economia de energia só funcionam apropriadamente se conectados a computadores que possuem recursos de economia de energia.*

한국어

절전디자인

이 프로그램은 컴퓨터 장비 제조업체가 해당 제품에 회로를 내장하여, 사용하지 않는 기간에 전력 소비를 줄일 수 있도록 만들어졌습니다.

이 모니터를 VESA DPMS(Display Power Management Signaling) 프로토콜을 준수하는 화면 비움 소프트웨어가 있는 PC 와 함께 사용하면 사용하지 않는 기간에 전력 소비를 줄여서 에너지를 상당히 절약할 수 있습니다.

두 개의 신호 라인과 세개의 동작모드 [온 모드 , 절전 모드 , 오프 모드) 가 존재합니다 .

모드	정의
온 모드	정상적인 동작상태 . 전원에 연결되어 있고 스크린에 정상적인 이미지를 표시하고 있다 .
절전 모드	컴퓨터로 부터 지시를 받은 후 또는 기타 기능에 의해 모니터의 전력이 저감되는 상태 . 이 모드에서는 스크린에 아무 것도 표시되지 않으며, 사용자 또는 컴퓨터로 부터의 지령 (마우스 동작 , 키보드 입력) 에 의해 가동 상태인 온 모드로 전환 된다 .
오프 모드	가장 낮은 전력 소비 상태 . 전원 스위치를 이용해 전원을 오프시킨 상태이다 .

참 고

- 모니터 절전 기능은 절전 기능이 있는 컴퓨터에 연결되어 있는 경우에만 사용할 수 있습니다 .

DEUTSCH

Energiespar-Design

Dieses Programm wurde konzipiert, um die Hersteller von Computergeräten zu veranlassen, Schaltungen in ihre Produkte einzubauen, die zu einem geringeren Stromverbrauch führen, wenn das Gerät nicht in Betrieb ist.

Wenn dieser Bildschirm zusammen mit einem PC verwendet wird, auf dem eine Software zur Abschaltung des Bildschirms installiert ist, die dem VESA Display Power Management Signalling (DPMS)-Protokoll entspricht, kann er erheblich Energie sparen, indem er den Stromverbrauch reduziert, wenn er nicht in Betrieb ist.

Es gibt 2 Signalleitungen, 3 Betriebsmodi: Ein Modus, Ruhemodus, Aus Modus.

Modus	Definition
Ein Modus	Der normale Betrieb. Wenn der Bildschirm im Ein Modus ist, zeigt er ein Bild an, sofern er mit einer Stromquelle verbunden ist.
Ruhe-modus	Der reduzierte Energiezustand. Keht in den Ein Modus zurück, sobald der Benutzer die Maus bewegt oder eine Taste auf der Tastatur drückt.
Aus Modus	Der Zustand, in dem am wenigsten Energie verbraucht wird. Keht in den Ein Modus zurück, sobald der Benutzer einen Stromschalter drückt.

Hinweis:

- Die Bildschirme mit *Energiespar-Design* funktionieren nur, wenn sie an Computer mit *Energiesparfunktionen* angeschlossen sind.

MAGYAR

Energiatakarékos kialakítás

E program célja, hogy a számítógéptartozék-gyártók azon termékei, amelyek rendelkeznek az ehhez szükséges áramkörrel, alacsony fogyasztással üzemeljenek akkor, amikor nincsenek használatban.

Ha ezt a monitort olyan számítógéppel használja, amelyen VESA képernyűtápellátás-kezelés+ jelrendszer (DPMS) protokollt támogató képernyű+kikapcsoló szoftver van, jelentős mennyiség energiát takaríthat meg az áramfelvétel használaton kívüli állapotban való csökkentésével.

2 jelvonal van 3 m kódési móddal:
Bekapcsolt mód, Alvás mód, Kikapcsolt mód.

Mód	Leírás
Bekapcsolt mód	Ez a normál m kódés módja. Amikor a monitor bekapcsolt módban van, és áramforráshoz van csatlakoztatva, egy képet jelenít meg.
Alvás mód	Ez a csökkentett áramfelvétel állapot. A bekapcsolt módba az egér mozgásával vagy egy billentyű lenyomásával térhet vissza.
Kikapcsolt mód	A legkisebb fogyasztással járó állapot. A bekapcsológomb megnyomásával térhet vissza a bekapcsolt állapotba.

Megjegyzés

- Az energiatakarékos kialakítással készült monitorok csak akkor m kódnek, ha olyan számítógépre csatlakoztatja, amely rendelkezik energiatakarékosági funkciókkal.

BAHASA INDONESIA

Desain Hemat Energi

Program ini dirancang agar produsen peralatan komputer membangun sistem sirkuit ke dalam produk mereka untuk mengurangi konsumsi daya saat peralatan sedang tidak beroperasi.

Saat monitor ini digunakan dengan komputer PC di mana perangkat lunak pengosong layar yang sesuai dengan Protokol Display Power Management Signalling (DPMS) terinstal, monitor dapat menghemat energi secara signifikan dengan mengurangi konsumsi daya saat sedang tidak beroperasi.

Terdapat 2 saluran sinyal, 3 mode operasi: Mode On (Menyala), Mode Sleep (Tidur), Mode Off (Mati).

Mode	Definisi
Mode On	Operasi normal. Saat monitor berada dalam mode on, terhubung dengan sumber daya, monitor menampilkan gambar.
Mode Sleep	Keadaan dengan daya yang dikurangi. kembali ke mode on saat pengguna menggerakkan mouse atau menekan tombol pada keyboard.
Mode Off	Keadaan dengan konsumsi daya terendah. kembali ke mode on saat pengguna menekan tombol daya.

Catatan

- Monitor dengan desain hemat energi hanya bekerja ketika terhubung dengan komputer yang memiliki fitur hemat energi.

日本語

省エネ設計 (省エネルギー設計、節電設計)

本プログラムはコンピュータ機器メーカーが製造する製品がその非使用時（非動作時）は消費電力を抑える回路構成を持つことを目的に策定されました。

本モニターを VESA が策定した DPMS(Display Power Management Signaling) プロトコルに準拠した スクリーンブランキング(スクリーンセーバー)ソフトウェアをインストールした PC と一緒にご使用することで、本モニターの非使用時(非動作時)の消費電力を大幅に抑えることができます。

2つの信号ラインと、3つの操作モードがあります。操作モードはオンモード、スリープモード、そしてオフモードの3つです。

モード	説明
オン モード	通常の使用時（通常の動作時）モニターがオンモードで電源は接続されているとき画像が表示されます。
スリープモード	省電力の状態です。マウスを動かさずかキーボードのどれかのキーを押すとオンモードに戻ります。
オフ モード	最も消費電力が少ない状態です。電源スイッチを入れるとオンモードに戻ります。

注（ご注意）

- 省電力設計のモニターは省電力機能を備えたコンピュータに接続されたときのみ有効です。

ESPAÑOL

Diseño de ahorro de energía

Este programa está diseñado para que los fabricantes de equipos informáticos incorporen sistemas de circuitos a sus productos con el fin de reducir el consumo de energía cuando no esté funcionando el aparato.

Cuando este monitor se utiliza con un PC en el que esté instalado un software de apagado de pantalla que cumpla con el protocolo DPMS (Display Power Management Signalling – señalización de la gestión de la energía de la pantalla) de VESA, se puede ahorrar una importante cantidad de energía reduciendo su consumo cuando no se utiliza.

Hay 2 líneas de señal y 3 modos de funcionamiento:
Modo Encendido, Modo Desconexión automática, Modo Apagado

Modo	Definición
Modo Encendido	Funcionamiento normal. Cuando el monitor se encuentra en el modo encendido, si está conectado a la corriente, muestra una imagen.
Modo Desconexión automática	Estado de uso reducido de energía. Vuelve al modo encendido cuando el usuario mueve el ratón o pulsa una tecla del teclado.
Modo Apagado	El estado de menor consumo de energía. Vuelve al modo encendido cuando el usuario pulsa el interruptor.

Nota

- Los monitores con diseño de ahorro de energía sólo funcionan cuando están conectados a ordenadores con capacidad de ahorro de energía.

ҚАЗАҚША

Энергия үнемдейтін дизайн

Бұл бағдарлама компьютер жабдықтарын өндірушілерге жұмыс істемей тұрғанда, қуаттың тұтынылуын азайту мақсатымен өнімдеріне электр схемасын енгіздіруге арналған.

Монитор VESA DPMS протоколына сәйкес келетін экранды жабу бағдарламалық құралы орнатылған компьютермен пайдаланылса, ол жұмыс істемей тұрғанда, қуаттың тұтынылуын азайтып, энергияның едәуір мөлшерін сақтайды.

Жұмыстың 2 сигналдық желісі мен 3 режимі бар :
Қосу режимі, Күту режимі, Өшіру режимі.

режимі	Анықтама
Қосу режимі	Қалыпты жұмыс Монитор қуат көзіне жалғанып, қосу режимінде тұрғанда, онда сурет көрсетіледі.
Күту режимі	Пайдаланушы тінтуірді жылжытқанда немесе пернетақтадағы бір пернені басқанда, азайтылған қуат күйі қосу режиміне қайтады.
Өшіру режимі	Пайдаланушы қуат қосқышын басқанда, қуатты тұтынудың ең төменгі күйі қосу режиміне қайтады.

Ескертпе

- Энергия үнемдейтін дизайнды мониторлар энергияны үнемдеу мүмкіндіктері бар компьютерлерге қосылып тұрғанда ғана жұмыс істейді.

NEDERLANDS

Energiebesparend ontwerp

Dit programma stimuleert fabrikanten van computerapparatuur om schakelingen in producten te bouwen die het stroomverbruik verminderen als de apparatuur niet wordt gebruikt.

Als deze monitor wordt gebruikt in combinatie met een pc waarop schermuitschakelsoftware is geïnstalleerd die compatible is met het VESA Display Power Management Signalling-protocol (DPMS), kunt u aanzienlijk veel energie besparen door het stroomverbruik te verminderen als de monitor niet wordt gebruikt.

Er zijn 2 signaallijnen en 3 bedrijfsmodi: de aan modus, de slaapmodus en de uit modus.

Modus	Definitie
Aan modus	De normale bedrijfsmodus. Als de monitor in aan modus staat en op een stroombron wordt aangesloten, wordt er beeld weergegeven.
Slaapmodus	De stand voor minder stroomverbruik. Keert terug naar aan modus als de gebruiker de muis beweegt of een toets op het toetsenbord indrukt.
Uit modus	De stand voor het laagste stroomverbruik. Keert terug naar aan modus als de gebruiker een stroomschakelaar indrukt.

Opmerking

- Monitors met een energiebesparend ontwerp werken alleen als ze worden aangesloten op computers met energiebesparende functies.

FRANÇAIS

Design d'économie d'énergie

Ce programme est conçu pour obtenir l'installation de circuits par les fabricants d'équipements informatiques dans leurs produits afin de réduire la consommation en courant de ces derniers lorsqu'ils ne sont pas en fonctionnement

Lorsque ce moniteur est utilisé avec un PC sur lequel est installé un logiciel d'effacement d'écran conforme au protocole DPMS VESA (Display Power Management Signalling), il peut économiser une énergie significative en réduisant la consommation de courant lorsqu'il n'est pas en fonctionnement.

Il dispose de 2 lignes de signaux et de 3 modes de fonctionnement :
Mode activé (On), mode de veille (Sleep), mode désactivé (Off).

Mode	Définition
Mode activé (On)	Le fonctionnement normal. Lorsque le moniteur est en mode activé, étant connecté à une source d'alimentation, il affiche une image.
Mode de veille (Sleep)	L'état d'alimentation réduit. Le moniteur retourne au mode activé lorsque l'utilisateur déplace la souris ou appuie sur une touche sur le clavier.
Mode désactivé (Off)	L'état d'alimentation en énergie le plus faible. Le moniteur retourne au mode activé lorsque l'utilisateur appuie sur un interrupteur marche/arrêt.

Note

- *Les moniteurs design économiques en énergie fonctionnent uniquement lorsqu'ils sont connectés à des ordinateurs disposant de fonctionnalités d'économie d'énergie.*

ΕΛΛΗΝΙΚΑ

Σχεδίαση εξοικονόμησης ενέργειας

Το πρόγραμμα αυτό έχει σχεδιαστεί ώστε οι κατασκευαστές εξοπλισμού ηλεκτρονικών υπολογιστών να δημιουργούν τη διάταξη των κυκλωμάτων στα προϊόντα τους με τέτοιο τρόπο ώστε να μειώνεται η κατανάλωση ενέργειας όταν βρίσκονται εκτός λειτουργίας.

Όταν η οθόνη αυτή χρησιμοποιείται με υπολογιστή, στον οποίο έχει εγκατασταθεί λογισμικό κενής οθόνης που συμμορφώνεται με το πρωτόκολλο Display Power Management Signalling (DPMS - Σηματοδότηση διαχείρισης ενέργειας οθόνης) της VESA, μπορεί να επιτύχει σημαντική εξοικονόμηση ενέργειας μειώνοντας την κατανάλωση ρεύματος όταν βρίσκεται εκτός λειτουργίας.

Υπάρχουν 2 γραμμές σήματος, 3 τρόποι λειτουργίας :
Σε λειτουργία, Σε αδράνεια, Εκτός λειτουργίας.

Λειτουργία	Ορισμός
Σε λειτουργία	Η κανονική λειτουργία. Όταν η οθόνη βρίσκεται σε λειτουργία και είναι συνδεδεμένη με μια πηγή τροφοδοσίας, εμφανίζεται εικόνα.
Σε αδράνεια	Όταν η οθόνη βρίσκεται σε κατάσταση μειωμένης ενέργειας και ο χρήστης μετακινεί το ποντίκι ή πατάει κάποιο πλήκτρο στο πληκτρολόγιο, τότε η οθόνη επιστρέφει σε λειτουργία.
Εκτός λειτουργίας	Όταν η οθόνη βρίσκεται σε κατάσταση χαμηλότερης κατανάλωσης ενέργειας και ο χρήστης πατάει το διακόπτη λειτουργίας, τότε η οθόνη επιστρέφει σε λειτουργία.

Σημείωση

- *Οι οθόνες με σχεδίαση εξοικονόμησης ενέργειας λειτουργούν μόνο όταν είναι συνδεδεμένες με υπολογιστές που διαθέτουν δυνατότητες εξοικονόμησης ενέργειας.*

УКРАЇНСЬКА

Програма енергозбереження

Ця програма має на меті стимулювати виробників комп'ютерного обладнання до впровадження у своїх виробках засобів зменшення енергоспоживання під час простою.

Якщо на підключеному персональному комп'ютері встановлено програмне забезпечення вимкнення екрана, сумісне з протоколом сигналів керування живленням дисплея VESA DPMS, цей монітор забезпечує суттєву економію електроенергії за рахунок зниження енергоспоживання в той час, коли ним не користуються.

Передбачено 2 сигнальні лінії та 3 режими роботи:
"ввімкнено", "очікування" та "вимкнено".

Режим	Пояснення
Режим "увімкнено"	Звичайний режим роботи виробу. Коли монітор підключений до джерела живлення і ввімкнений, на екрані відображається зображення.
Режим очікування	У цьому режимі монітор споживає менше електроенергії. З нього можна повернутися в режим "увімкнено" порухом мишки або натисненням будь-якої клавіші на клавіатурі.
Режим "вимкнено"	У цьому режимі енергоспоживання монітора мінімальне. З нього можна повернутися в режим "увімкнено" натисненням кнопки живлення на моніторі.

Примітка

- Функція енергозбереження монітора працюватиме лише за умови наявності відповідної функції на під'єднаному комп'ютері.

ITALIANO

Programma di risparmio energetico

Questo programma è stato messo a punto affinché i produttori di computer producano circuiti per i loro prodotti in grado di limitare il consumo energetico quando non sono in funzione.

Quando questo monitor viene utilizzato con un PC su cui è installato un software per l'annullamento dello schermo conforme al protocollo VESA DPMS (Display Power Management Signalling), è in grado di risparmiare una quantità significativa di energia riducendo il consumo quando non è in funzione.

Sono disponibili 2 linee di segnale, 3 modalità operative:
Modalità On, modalità Sleep, modalità Off.

Modalità	Definizione
Modalità On	Funzionamento normale. Quando il monitor si trova in modalità On ed è connesso a una sorgente elettrica, viene visualizzata un'immagine.
Modalità Sleep	Stato di consumo energetico ridotto. Torna alla modalità On quando l'utente sposta il mouse o preme un tasto sulla tastiera.
Modalità Off	Stato di consumo energetico ridotto al massimo. Torna alla modalità On quando l'utente preme un interruttore.

Nota

- I monitor conformi al Programma di risparmio energetico funzionano solo se connessi a computer dotati di funzionalità di risparmio energetico.

РУССКИЙ

Функция сохранения энергии

Эта программа разработана для создания и внедрения производителями компьютерного оборудования схем, позволяющих снизить потребление электроэнергии, когда компьютер не находится в рабочем режиме.

Если монитор используется с ПК, на котором установлено программное обеспечение для затемнения экрана, соответствующее протоколу VESA Display Power Management Signalling (DPMS), он может экономить энергию, сокращая ее потребление, когда не находится в рабочем режиме.

Существуют 2 сигнальные линии, 3 режима работы:
Включен, Ожидание, Выключен

Режим	Описание
Включен	Обычный режим работы. Когда монитор подключен к источнику питания и находится в режиме «Включен», он выводит изображение на экран.
Ожидание	Энергопотребление снижено. Компьютер возвращается в режим «Включен», когда пользователь перемещает мышь или нажимает любую клавишу на клавиатуре.
Выключен	Энергопотребление минимально. Компьютер переходит в режим «Включен», когда пользователь нажимает кнопку включения питания.

Примечание

- Мониторы с функцией сохранения энергии работают только при соединении с компьютерами, поддерживающими эту функцию.

POLSKI

Oszczędzanie energii

Ten program został stworzony, aby producenci sprzętu komputerowego mieli możliwość wbudowania do swoich produktów zespołów obwodów elektrycznych redukujących pobór mocy w stanie bezczynności.

W przypadku użycia tego monitora na komputerze osobistym (PC), na którym zainstalowano oprogramowanie wygaszające ekran zgodne z protokołem VESA (DPMS – Display Power Management Signalling), umożliwi on zaoszczędzenie znacznych ilości energii poprzez redukcję poboru mocy w stanie bezczynności.

Istnieją 2 linie sygnału, 3 tryby pracy:
Włączony, Uśpienie, Wyłączony.

Tryb	Definicja
Włączony	Normalny proces działania. W trybie „włączony” monitor podłączony jest do źródła zasilania i wyświetla obraz.
Uśpienie	Stan zredukowanego poboru mocy. Przywraca do stanu „włączony”, gdy użytkownik poruszy myszką lub przyćmi dowolny klawisz na klawiaturze.
Wyłączony	Stan najmniejszego poboru mocy. Przywraca do stanu „włączony”, gdy użytkownik naciśnie włącznik zasilania.

Uwaga

- Monitory z funkcją oszczędzania energii działają tylko, jeśli są podłączone do komputerów posiadających właściwości oszczędzania energii.

繁體中文

العربية

節能設計

此程式用於幫助電腦設備製造廠商在他們的產品中建立電路，藉以降低產品處於非作業狀態時的功率消耗量。

本顯示器與已安裝符合 VESA 顯示能源管理訊號 (DPMS) 協定之螢幕抑制顯示軟體的電腦配合使用時，可降低處於非作業狀態時的功率消耗量，進而節省大量能源。

共有 2 根訊號線以及 3 種作業模式：
開啟模式、睡眠模式和關閉模式。

模式	定義
開啟模式	正常作業模式。 顯示器與電源連接並處於開啟模式時，會顯示影像。
睡眠模式	低功率消耗狀態。 若使用者移動滑鼠或按鍵盤上的鍵，則返回開啟模式。
關閉模式	最低功率消耗狀態。 若使用者按電源開關，則返回開啟模式。

註

- 該節能設計顯示器僅在連接至具有節能功能的電腦時才能發揮其節能作用。

تصميم موفر للطاقة

تم إعداد هذا البرنامج بحيث تتمكن شركات تصنيع أجهزة الكمبيوتر من إدماج مجموعة دارات إلكترونية في منتجاتها للحد من استهلاك الطاقة عند تشغيل المنتج.

فبعد استخدام هذه الشاشة مع جهاز كمبيوتر عليه برنامج الشاشة الفارغة المتوافق مع بروتوكول بث إشارات إدارة طاقة الشاشة (DPMS) المثبت وفق معايير VESA، قد توفر حجماً كبيراً من الطاقة من خلال الحد من استهلاك الطاقة عند عدم تشغيلها.

يتوفر خطأ إشارة، وثلاثة أوضاع تشغيل.
وضع التشغيل، ووضع السكون، ووضع إيقاف التشغيل.

وضع	التعريف
وضع التشغيل	التشغيل العادي تعرض الشاشة صورة عندما تكون في وضع التشغيل ومتصلة بمصدر طاقة.
وضع السكون	تعود حالة توفير الطاقة إلى وضع التشغيل عندما يحرك المستخدم الماوس أو يضغط على أي مفتاح على لوحة المفاتيح.
وضع إيقاف التشغيل	تعود حالة استهلاك الطاقة الأدنى إلى وضع التشغيل عندما يضغط المستخدم على مفتاح الطاقة.

ملاحظة

- تعمل الشاشات ذات التصميم الموفر للطاقة فقط عند توصيلها بأجهزة الكمبيوتر المزودة بميزات توفير الطاقة.

ENGLISH

Service

Unplug the monitor from the wall outlet and refer servicing to qualified service personnel when :

- The power cord or plug is damaged or frayed.
- Liquid has been spilled into the monitor.
- The monitor has been exposed to rain or water.
- The monitor does not operate normally following the operating instructions. Adjust only those controls that are covered in the operating instructions. An improper adjustment of other controls may result in damage and often requires extensive work by a qualified technician to restore the monitor to normal operation.
- The monitor has been dropped or the cabinet has been damaged.
- The monitor exhibits a distinct change in performance.
- Snapping or popping from the monitor is continuous or frequent while the monitor is operating. It is normal for some monitors to make occasional sounds when being turned on or off, or when changing video modes.

Do not attempt to service the monitor yourself, as opening or removing covers may expose you to dangerous voltage or other hazards. Refer all servicing to qualified service personnel.

DEUTSCH

Wartun

Bei folgenden Fehlerbedingungen ist der Netzstecker des Monitors zu ziehen und der Kundendienst zu benachrichtigen:

- Wenn der Netzstecker beschädigt oder das Netzkabel ausgefranst ist.
- Wenn Flüssigkeit in den Monitor gelaufen ist.
- Wenn der Monitor Regen oder Feuchtigkeit ausgesetzt worden ist.
- Wenn der Monitor trotz Befolgung aller Bedienungsanweisungen nicht ordnungsgemäss arbeitet. Benutzen Sie ausschliesslich die Bedienelemente, die in den Hinweisen dieses Handbuchs beschrieben werden. Werden andere Bedienelemente geändert oder verstellt, können Schaden entstehen, die nur von einem qualifizierten Service-Techniker behoben werden können.
- Wenn der Monitor fallengelassen und das Gehäuse beschädigt wurde.
- Wenn beim Betrieb des Monitors häufig oder lang anhaltend knackende oder knallende Nebengeräusche auftreten. Hiermit sind nicht die typischen Geräusche gemeint, die beim Ein- oder Ausschalten des Monitors zu hören sind.

Führen Sie keine Wartungsarbeiten selbst durch. Durch Öffnen oder Entfernen wichtiger Abdeckungen werden spannungsführende Teile freigelegt, so dass eine erhöhte Gefährdung besteht. Für Wartungsarbeiten in diesen Bereichen ist der Kundendienst zuständig.

FRANÇAIS

Maintenance du Moniteur

Débranchez le moniteur (prise murale) et contactez un technicien qualifié de maintenance de ce type d'équipement dans les cas suivants:

- Le cordon d'alimentation ou la prise est endommagé(e) ou dénudé.
- Du liquide a coulé à l'intérieur du moniteur.
- Le moniteur a été exposé à la pluie ou à l'humidité.
- Le moniteur ne fonctionne pas normalement lorsque vous suivez les instructions du mode d'emploi. Ne réglez que les éléments décrits dans le mode d'emploi. Un réglage inadéquat d'autres éléments peut entraîner une détérioration de l'appareil et nécessite souvent un important travail du technicien qualifié pour remettre le moniteur en bon état de fonctionnement.
- Le moniteur est tombé ou son boîtier a été endommagé.
- Le moniteur présente un changement net dans ses capacités de fonctionnement.
- Des bruits secs ou des bruits d'encliquetage 'clic' se font entendre en continu ou fréquemment en cours de fonctionnement du moniteur. Il est normal que certains moniteurs fassent des bruits occasionnels lorsqu'ils sont mis sous tension ou hors tension, ou lors de changements de mode vidéo.

Ne tentez pas de réparer vous-même votre moniteur, car ouvrir le moniteur ou retirer son boîtier peut vous exposer à des décharges électriques dangereuses et présente par ailleurs d'autres risques. Pour toute réparation du moniteur, contactez un technicien qualifié.

ITALIANO

Manutenzione

Staccare il monitor dalla presa elettrica e consultare il personale addetto alla manutenzione quando:

- Il cavo elettrico o la spina sono danneggiati o consumati.
- Si è rovesciato del liquido sul monitor.
- Il monitor è stato esposto alla pioggia o all'acqua.
- Il monitor non funziona correttamente secondo le istruzioni operative. Regolare unicamente quei controlli contemplati nelle istruzioni operative. La manomissione di altri controlli può provocare danni e spesso poi è necessario un lungo lavoro da parte dei tecnici specializzati per ripristinare le normali funzionalità del monitor.
- Il monitor è caduto o si è danneggiata la struttura.
- Il monitor funziona in maniera evidentemente diversa da prima. Il monitor lampeggia in maniera continua o frequente mentre è in funzione. È normale che alcuni monitor emettano suoni occasionali quando vengono accesi o spenti, oppure quando si cambia la modalità video.

Non cercare di effettuare da soli la manutenzione poiché l'apertura della struttura potrebbe esporre l'utente al pericolo di scariche elettriche o ad altri rischi. Rivolgersi al personale tecnico qualificato.

ESPAÑOL

Servicio

Desconecte el monitor del tomacorriente de la pared y refiera el servicio a personal de servicio calificado cuando:

- El cable o enchufe de energía está dañado o desgastado.
- Se ha derramado líquido en el monitor.
- El monitor ha sido expuesto a la lluvia o al agua.
- El monitor no funciona normal aunque se hayan seguido las instrucciones de operación. Ajuste sólo los controles que están cubiertos en las instrucciones de operación. Un ajuste incorrecto de estos controles pueden causar daño y a veces requiere de trabajo extenso por un técnico calificado para restaurar el monitor al funcionamiento normal.
- El monitor se ha dejado caer o el gabinete se ha dañado.
- El monitor exhibe un cambio distinto en la ejecución.
- Los chasquidos o explosivos que emanan del monitor son continuos o frecuentes mientras el monitor está operando.
Los ruidos ocasionales son normales para algunos monitores cuando se prende o se apaga, o cambia el modo de video.

No trate de arreglar usted mismo el monitor, ya que abrir y sacar las tapas pueden exponerlo a niveles de voltaje peligrosos u otros peligros. Refiera el arreglo a un personal técnico calificado para ello.

PORTUGUÊS

Manutenção

Desligue o monitor da tomada e procure por serviço autorizado, quando:

- O cabo de força ou plugue estiver danificado ou rompido.
- Houve queda de líquido no monitor.
- O monitor foi exposto à chuva ou água.
- O monitor não opera normalmente seguindo as instruções de operação. Ajuste somente os controles descritos nas instruções de operação. Uma tentativa de ajuste de outros controles invalidará a garantia, além de exigir diversas horas de trabalho de pessoal qualificado para restaurar as condições originais de funcionamento do monitor.
- O monitor caiu ou está com o gabinete quebrado.
- O monitor exibe uma distinta mudança de performance.
- O monitor emite estalos ou estouros continuamente durante sua operação normal. Para alguns monitores é normal se ouvirem estalos quando se liga ou desliga o monitor ou quando há mudança de modo de vídeo.

Não tente efetuar a manutenção do monitor você mesmo. Abrir ou remover as tampas do gabinete deixarão expostos pontos de alta tensão em diversas partes do monitor. Procure sempre pessoal qualificado para execução de serviços de manutenção.

NEDERLANDS

Onderhoud

In de volgende gevallen haalt u de stekker van de monitor uit het stopcontact en roept u de hulp in van een gekwalificeerde technicus:

- Het netsnoer of de stekker is beschadigd of versleten.
- Er is vloeistof in de monitor gemorst.
- De monitor heeft blootgestaan aan regen of water.
- De monitor werkt niet goed, ondanks het feit dat u handelt volgens de gebruiksaanwijzing. Beperk u bij het instellen van de monitor tot de items die in de gebruiksaanwijzing worden besproken. Het onjuist instellen van andere items kan storingen veroorzaken. Vaak is dan een omvangrijke reparatie door een gekwalificeerde technicus nodig, om de monitor weer voor normaal gebruik in gereedheid te brengen.
- De monitor is gevallen of de behuizing is beschadigd.
- De monitor functioneert wezenlijk anders dan normaal het geval is.
- De monitor produceert voortdurend of regelmatig kraak- en knalgeluiden. Bij sommige monitoren is het normaal dat ze af en toe geluiden produceren bij het in- en uitschakelen, of wanneer ze veranderen van videomodus.

Probeer de monitor niet zelf te repareren, aangezien u bij het openen of verwijderen van de behuizing blootgesteld kunt worden aan gevaarlijke elektrische schokken of andere gevaren. Laat alle reparatiewerkzaamheden over aan gekwalificeerde technici.

РУССКИЙ

Ремонт и Обслуживание

В нижеперечисленных случаях отключите монитор от сети и обратитесь в пункты сервисного обслуживания:

- Если Вы повредили кабель питания или вилку.
- Если Вы пролили в монитор какую-нибудь жидкость.
- Если монитор подвергся воздействию воды или дождя.
- Если монитор не работает согласно нормативам, указанным в Инструкции. При этом используйте для регулировки только те кнопки управления, которые предлагаются пользователю в Инструкции. Неправильное манипулирование другими кнопками может привести к повреждению монитора и потребовать дорогостоящего ремонта.
- Если монитор подвергся удару при падении или если был поврежден его корпус.
- Если в мониторе возникли выраженные отклонения от нормального режима работы.
- Если монитор издает во время работы посторонние звуки, хотя для некоторых типов мониторов включение или выключение, как правило, сопровождается какими-либо звуками.

Не пытайтесь проводить самостоятельное техническое обслуживание монитора. Не подвержайте себя опасности воздействия высоких напряжений. Все работы должны выполняться только квалифицированным персоналом.

العربية

الخدمة

Maintenance Tel	
Dammam	8339561
Khobar	8942694
Hoffuf	5861262
Jubail	3624444
Riyadh	4652641
Jeddah	6531688
Makkah	5500110
Madina	8274793

- افصل الشاشة عن مأخذ الحائط واتصل بفريق خدمة محترف:
- إن سلك الطاقة أو المقبس نالغ أو بال.
 - انسكب سائل على الشاشة.
 - تعرضت الشاشة للمطر أو الماء.
 - لا تعمل الشاشة بشكل طبيعي باتباع الإرشادات التالية. اضبط عناصر التحكم المذكورة في إرشادات التشغيل فقط. إذ قد يؤدي الضبط غير الصحيح لبعض عناصر التحكم إلى إلحاق الضرر وغالباً ما قد يتطلب عملاً شاقاً من تقني محترف لإعادة الشاشة إلى وضع التشغيل العادي.
 - وقعت الشاشة أو قد تم إتلاف الصندوق.
 - أداء الشاشة متغير بشكل واضح.
 - تصدر الشاشة صوت طقطقة أو فرقعة بشكل متواصل أو متكرر أثناء التشغيل.
 - من الطبيعي أن تصدر بعض الشاشات أصواتاً مؤقتة عند تشغيلها أو إيقاف تشغيلها، أو عند تغيير أوضاع الفيديو.

لا تحاول صيانة الشاشة بنفسك، إذ قد يعرضك فتح الغطاء أو إزالته لفولتية خطيرة أو غيرها من المخاطر.
خصص أعمال الخدمة والصيانة لفريق الخدمة المحترف.

日本語

保守および修理

次のような保守になったら、モニターの電源プラグをコンセントから抜き、修理センターにご相談ください。

- 電源コードまたはプラグが破損した、または擦り切れた。
- モニターの内部に液体をこぼしてしまった。
- モニターが雨または水に濡れてしまった。
- 取扱説明書どおりに操作してもモニターにうまく画像が表示されない場合、お客様の方で調整するのは、取扱説明書で説明されているボタンを使った調整だけにしてください。
- モニターを床に落としてしまった。または、キャビネットを破損してしまった。
- モニターの性能が明らかに落ちてきた。
- モニターも使用中、常にまたは断続的にピシピシといった音やパンといった音がする。ただし、正常なモニターでも、電源を入れたりきったりしたときには音はする場合があります。

モニターのカバーを開いたり取り外したりすると、高電圧による感電その他の危険性があるので、モニターを自分で修理したりしないでください。修理が必要なときは、サービスマンに頼んでください。



警告

ディスプレイの裏ぶたを開けないでください。内部には高電圧の部分があり、感電の恐れがあります。



한국어

수리

다음과 같은 경우에는 벽면 콘센트에서 모니터의 플러그를 뺀 다음 자격이 있는 수리 담당자에게 의뢰하십시오.

- 전원코드 또는 플러그가 손상되거나 낡았습니다.
- 액체가 옆질러져서 모니터에 흘러들어갔습니다.
- 모니터가 비 또는 물에 노출되었습니다.
- 모니터가 일반적인 동작지침에 맞게 동작하지 않으며, 동작지침에 설명된 컨트롤만 조정합니다. 다른 컨트롤을 잘못 조정하여 손상된 것 같습니다. 모니터가 정상적으로 동작하도록 복원하려면 자격을 갖춘 기술자가 전반적으로 수리해야 합니다.
- 모니터를 떨어뜨렸거나 캐비닛이 손상되었습니다.
- 모니터의 성능이 눈에 띄게 달라졌습니다.
- 모니터가 작동하는 동안 모니터에서 스퍩 또는 팝 현상이 계속적으로 또는 자주 발생합니다. 모니터를 켜거나 끌 때 또는 비디오 모드를 변경할 때 일부 모니터에서 소리가 나는 경우가 있는데 이는 정상적인 것입니다.

덮개를 열거나 떼어내는 것은 감전의 우려 및 다른 위험 요소가 있으므로 모니터를 직접 수리하려고 하지 마십시오.

모든 수리는 자격을 갖춘 수리 담당자에게 의뢰하십시오.

*お問い合わせ先については提供されている「修理に関するご案内」カードのサービスセンター案内をご参照ください。



REGULATORY INFORMATION / RENSEIGNEMENTS RÉGLEMENTAIRES

Please read this manual carefully before operating your set and retain it for future reference.

Veillez lire ce manuel attentivement avant d'utiliser l'appareil et conservez-le pour pouvoir le consulter ultérieurement.

P/No. : SAC37093516 (2302-REV03)

Copyright © 2021 LG Electronics Inc. All Rights Reserved.

Copyright © 2021 LG Electronics inc. Tous droits réservés.

www.lg.com

EPEAT



"EPEAT registered where applicable/supported. EPEAT registration varies by country - see www.epeat.net for registration status by country."

JORDAN ONLY

WEEE



Disposal of your appliance

The symbol indicating separate collection for electrical and electronic equipment consists of the crossed-out wheeled bin.



الأردن فقط







WEEE

التخلص من الجهاز الخاص بك.

الرمز الذي يشير إلى مجموعة منفصلة من المعدات الإلكترونية والكهربائية هو عبارة عن صندوق قمامة بعجلات ومشطوب.







SYMBOLS (SYMBOLES)

Language						
English	Refers to alternating current(AC).	Refers to direct current(DC).	Refers to class II equipment.	Refers to stand-by.	Refer to "ON" (power).	Refers to dangerous voltage.
Svenska	Gäller växelström (AC).	Gäller likström (DC).	Gäller utrustning i klass II.	Gäller stand-by.	Gäller "PÅ" (ström).	Gäller farlig spänning.
Norsk	Refererer til vekselstrøm (AC).	Refererer til likestrøm (DC).	Refererer till klasse II-utstyr.	Refererer til ventemodus.	Refererer til "PÅ" (strøm).	Refererer til farlig spenning.
Dansk	Refererer til vekselstrøm (AC).	Refererer til jævnstrøm (DC).	Refererer til klasse II-udstyr.	Refererer til standby.	Refererer til "Tændt;" (Strøm).	Refererer til farlig elektrisk spænding.
Suomi	Viittaa vaihtovirtaan (AC).	Viittaa tasavirtaan (DC).	Viittaa II luokan laitteeseen.	Viittaa valmiustilaan.	Viittaa (virta) "päällä" -tilaan.	Viittaa vaaralliseen jännitteeseen.
Deutsch	Steht für Wechselstrom (AC).	Steht für Gleichstrom (DC).	Steht für Geräte der Klasse II.	Steht für Standby.	Steht für „EIN“ (Einschalten).	Steht für gefährliche Spannung.
Français	Fait référence au courant alternatif (CA).	Fait référence au courant continu (CC).	Fait référence à l'équipement de classe II.	Fait référence au mode veille.	Correspond à la commande "Marche" (marche-arrêt).	Fait référence à des tensions dangereuses.
Italiano	Indica la corrente alternata (CA).	Indica la corrente continua (CC).	Si riferisce ad apparecchiatura di classe II.	Indica lo stato di standby.	Indica lo stato di "accesso" (alimentazione).	Indica una tensione pericolosa.
Español	Se refiere a la corriente alterna (CA).	Se refiere a la corriente continua (CC).	Se refiere a equipos de clase II.	Se refiere al modo en espera.	Se refiere al modo "ON" (encendido).	Se refiere a voltajes peligrosos.
Português	Refere-se à corrente alternada (CA).	Refere-se à corrente contínua (CC).	Refere-se a um equipamento da Classe II.	Refere-se ao modo de suspensão.	Refere-se ao estado de alimentação "LIGADA".	Refere-se a tensão perigosa.
Nederlands	Verwijst naar wisselstroom(AC).	Verwijst naar gelijkstroom(DC).	Verwijst naar Klasse II-apparaatuur.	Verwijst naar stand-by.	Verwijst naar "AAN" (stroom).	Verwijst naar gevaarlijk voltage.
Ελληνικά	Υποδεικνύει το εναλλασσόμενο ρεύμα (AC).	Υποδεικνύει το συνεχές ρεύμα (DC).	Υποδεικνύει τον εξοπλισμό κατηγορίας II.	Υποδεικνύει την κατάσταση αναμονής.	Υποδεικνύει την "ΕΝΕΡΓΟΠΟΙΗΣΗ" (λειτουργία).	Υποδεικνύει επικίνδυνη τάση.
Magyar	Váltóáramot jelent (AC).	Egyenáramot jelent (DC).	Class II berendezést jelent.	Készletlen állapotot jelent.	Bekapcsolt állapotot jelent (tápellátás).	Veszélyes feszültséget jelent.
Polski	Oznacza prąd zmienny(AC).	Oznacza prąd stały(DC).	Oznacza urządzenie klasy ochronności II.	Oznacza tryb czuwania.	Oznacza przycisk „Wł.” (zasilanie).	Oznacza niebezpieczne napięcie.
Česky	Označuje střídavý proud (AC).	Označuje stejnosměrný proud (DC).	Označuje zařízení třídy II.	Označuje pohotovostní režim.	Označuje režim „ZAPNUTO” (napájení).	Označuje nebezpečné napětí.
Slovenčina	Označuje striedavý prúd (AC).	Označuje jednosmerný prúd (DC).	Označuje zariadenie triedy II.	Označuje pohotovostný režim.	Označuje stav „ZAP” (napájanie).	Označuje nebezpečné napätie.
Русский	Означает переменный ток (AC).	Означает постоянный ток (DC).	Означает оборудование класса II.	Означает режим ожидания.	Означает "ВКЛ." (питание).	Означает опасное напряжение.
Қазақша	Айнымалы токқа қатысты.	Тұрақты токқа қатысты.	II класы жабдықа қатысты.	Тірекке қатысты.	«ҚОСУ» (қуат) күйіне қатысты.	Қауіпті кернеуге қатысты.
Українська	Позначає змінний струм.	Позначає постійний струм.	Позначає обладнання класу II.	Позначає стан очікування.	Позначає стан "увімкнення" (живлення).	Позначає небезпечну напругу.
O'zbekcha	O'zgaruvchan tokni anglatadi (AC).	O'zgarmas tokni anglatadi (DC).	II-sinf quirlmasi ekanligini anglatadi.	Kutish rejimini anglatadi.	"YOQLGAN" (quvvat)ni anglatadi.	Xavfli kuchlanishni anglatadi.

Language	~	==	☐	⏻		⚡
Türkçe	Alternatif akımı (AC) niteler.	Doğru akımı (DC) niteler.	Sınıf II donanımı niteler.	Beklemeyi niteler.	"AÇIK" (güç) durumunu niteler.	Tehlikeli voltajı niteler.
العربية	يشير هذا الرمز إلى التيار المتردد (AC).	يشير هذا الرمز إلى التيار المستمر (DC).	يشير هذا الرمز إلى الأجهزة من الفئة II.	يشير هذا الرمز إلى الاستعداد.	يشير هذا الرمز إلى "تشغيل" (الطاقة).	يشير هذا الرمز إلى الفولتية الخطرة.
עברית	מתייחס לזרם חילופין (AC).	מתייחס לזרם ישיר (DC).	מתייחס לציוד בדרגה II.	מתייחס להמתנה.	מתייחס ל"מופעל" (הפעלה).	מתייחס למתח מסוכן.
Español (latin)	Se refiere a la corriente alterna (ca)	Se refiere a la corriente continua (cc)	Se refiere a los equipos clase II	Se refiere al modo de espera	Se refiere a "ENCENDIDO" (alimentación)	Se refiere a voltaje peligroso
FRANÇAIS (CANADA)	Se rapporte au courant alternatif (c.a.)	Se rapporte au courant continu (c.c.)	Se rapporte à un appareil de classe II	Se rapporte à la mise en veille	Se rapporte à la mise en marche (alimentation)	Se rapporte à une tension dangereuse
BAHASA INDONESIA	Mengacu pada arus bolak-balik (AC)	Mengacu pada arus searah (DC)	Mengacu pada peralatan kelas II	Mengacu pada siaga	Mengacu pada "AKTIF" (daya)	Mengacu pada tegangan berbahaya
日本語	交流 (AC) を表します	直流 (DC) を表します	クラスIIの装置を表します	スタンバイを表します	「オン」(電源)を表します	危険な電圧を表します
한국어	교류 (AC)를 의미	직류 (DC)를 의미	II급 기기를 의미	대기 상태를 의미	전원 "ON" 상태를 의미	위험 전압을 의미
Português (brazil)	Refere-se à corrente alternada (CA)	Refere-se à corrente contínua (CC)	Refere-se ao equipamento de classe II	Refere-se a stand-by	Refere-se à "LIGADO" (Liga/Desliga)	Refere-se à tensão perigosa
ประเทศไทย	หมายถึง ไฟฟ้ากระแสสลับ (AC)	หมายถึง ไฟฟ้ากระแสตรง (DC)	หมายถึงอุปกรณ์ Class II	หมายถึงสแตนด์บาย	หมายถึง "เปิด" (พลังงาน)	หมายถึงแรงดันไฟฟ้าอันตราย
简体中文	表示交流电 (AC)	表示直流电 (DC)	表示 II 类设备	表示待机	表示 "开" (电源)	表示危险电压
繁體中文	代表交流電 (AC)	代表直流電 (DC)	代表 II 級設備	代表待機	代表「開啟」(電源)	代表危險電壓

Language				
English	CAUTION	Instructions	Coin / button cell battery	Moving parts
Svenska	VARNING	Instruktioner	Knappcells batteri	Rörliga delar
Norsk	ADVARSEL	Instruksjoner	Knappcellebatteri	Bevegelige deler
Dansk	FORSIGTIG	Vejledning	Mønt-/ knappcellebatteri	Bevægelige dele
Suomi	VAARA	Ohjeet	Kolikko-/nappiparisto	Liikkuvia osia
Deutsch	VORSICHT	Anweisungen	Knopfzellenbatterie	Bewegliche Bauteile
Français	MISE EN GARDE	Instructions	Pile bouton	Pièces mobiles
Italiano	ATTENZIONE	Istruzioni	Batteria a bottone	Parti mobili
Español	PRECAUCIÓN	Instrucciones	Pila de tipo moneda/ botón	Piezas móviles
Português	CUIDADO	Instruções	Pilha botão/em forma de moeda	Peças em movimento
Nederlands	LET OP	Instructies	Knoopcelbatterij	Bewegende onderdelen
Ελληνικά	ΠΡΟΣΟΧΗ	Οδηγίες	Μπαταρία σε σχήμα νομίσματος/ κουμπιού	Κινούμενα εξαρτήματα
Magyar	FIGYELEM	Utasítások	Gombelem	Mozgó alkatrészek
Polski	PRZESTROGA	Instrukcje	Bateria guzikowa/ pastylkowa	Części ruchome
Česky	UPOZORNĚNÍ	Pokyny	Knoflíková baterie	Pohyblivé části
Slovenčina	UPOZORNENIE	Pokyny	Gombíková batéria	Pohyblivé časti
Русский	ВНИМАНИЕ!	Инструкции	Элементы питания кнопочного/ таблеточного типа	Движущиеся детали
Қазақша	АБАЙЛАҢЫЗ!	Нұсқаулар	Тыын/түйме пішінді батарея	Жылжымалы бөліктер
Українська	УВАГА!	Вказівки	Батарея у формі монети/таблетки	Рухомі деталі
O'zbekcha	DIQQAT!	Yo'riqnomasi	Tanga / tabletkasimon batareya	Harakatlanuvchi qismlar
Türkçe	DİKKAT	Kullanım Talimatları	Madeni / düğme pil	Hareketli parçalar
العربية	تنبيه	تعليمات	بطارية ذات خلايا على شكل عملة/زر	الأجزاء المتحركة
עברית	זהירות	הנחיות	סוללת מטבע / כפתור	חלקים נעים

Language				
Español (latin)	PRECAUCIÓN	Instrucciones	Batería de moneda/ botón	Piezas móviles.
FRANÇAIS (CANADA)	MISES EN GARDE	Instructions	Pile bouton	Pièces mobiles
BAHASA INDONESIA	PERHATIAN	Petunjuk	Baterai sel berbentuk koin/ kancing	Komponen yang bergerak
日本語	注意	取扱説明書	コイン/ボタン電池	可動部分
한국어	주의	설명서	코인/버튼 단전지	가동부
Português (brazil)	CUIDADO	Instruções	Bateria de célula tipo moeda/botão	Peças em movimento
ประเทศไทย	ขอความร่วมมือ	คำแนะนำ	แบตเตอรี่เซลล์เหรียญ / เซลล์กระดุม	ชิ้นส่วนที่เคลื่อนไหวได้
简体中文	注意	说明	硬币型/纽扣型电池	活动部件
繁體中文	警告	指示	硬幣型 / 鈕扣型電池	可動部分

