

E13863



ROG  
SWIFT PG480Q  
USER GUIDE

ASUS

**Copyright © 2022 ASUSTeK COMPUTER INC. All Rights Reserved.**

No part of this manual, including the products and software described in it, may be reproduced, transmitted, transcribed, stored in a retrieval system, or translated into any language in any form or by any means, except documentation kept by the purchaser for backup purposes, without the express written permission of ASUSTeK COMPUTER INC. ("ASUS").

Product warranty or service will not be extended if: (1) the product is repaired, modified or altered, unless such repair, modification or alteration is authorized in writing by ASUS; or (2) the serial number of the product is defaced or missing.

ASUS PROVIDES THIS MANUAL "AS IS" WITHOUT WARRANTY OF ANY KIND, EITHER EXPRESS OR IMPLIED, INCLUDING BUT NOT LIMITED TO THE IMPLIED WARRANTIES OR CONDITIONS OF MERCHANTABILITY OR FITNESS FOR A PARTICULAR PURPOSE. IN NO EVENT SHALL ASUS, ITS DIRECTORS, OFFICERS, EMPLOYEES OR AGENTS BE LIABLE FOR ANY INDIRECT, SPECIAL, INCIDENTAL, OR CONSEQUENTIAL DAMAGES (INCLUDING DAMAGES FOR LOSS OF PROFITS, LOSS OF BUSINESS, LOSS OF USE OR DATA, INTERRUPTION OF BUSINESS AND THE LIKE), EVEN IF ASUS HAS BEEN ADVISED OF THE POSSIBILITY OF SUCH DAMAGES ARISING FROM ANY DEFECT OR ERROR IN THIS MANUAL OR PRODUCT.

SPECIFICATIONS AND INFORMATION CONTAINED IN THIS MANUAL ARE FURNISHED FOR INFORMATIONAL USE ONLY, AND ARE SUBJECT TO CHANGE AT ANY TIME WITHOUT NOTICE, AND SHOULD NOT BE CONSTRUED AS A COMMITMENT BY ASUS. ASUS ASSUMES NO RESPONSIBILITY OR LIABILITY FOR ANY ERRORS OR INACCURACIES THAT MAY APPEAR IN THIS MANUAL, INCLUDING THE PRODUCTS AND SOFTWARE DESCRIBED IN IT.

Products and corporate names appearing in this manual may or may not be registered trademarks or copyrights of their respective companies, and are used only for identification or explanation and to the owners' benefit, without intent to infringe.

# Contents

Notices.....	iv
Safety Information .....	v
Care & Cleaning .....	vi
Takeback Services.....	vii
<b>Chapter 1: Product Introduction</b>	
1.1 Welcome! .....	1-1
1.2 Package Contents .....	1-1
1.3 Monitor Introduction .....	1-2
1.3.1 Front View .....	1-2
1.3.2 Back View .....	1-3
1.3.3 Remote Control.....	1-4
1.3.4 GamePlus Function .....	1-5
1.3.5 GameVisual Function.....	1-7
<b>Chapter 2: Setup</b>	
2.1 Attaching the Stand .....	2-1
2.2 Cable Management .....	2-2
2.3 Detaching the Stand (for VESA wall mount).....	2-3
2.4 Connecting the Cables .....	2-4
2.5 Turning On the Monitor .....	2-5
<b>Chapter 3: General Instructions</b>	
3.1 OSD (On-Screen Display) Menu.....	3-1
3.1.1 How to Reconfigure .....	3-1
3.1.2 OSD Function Introduction.....	3-2
3.2 Specifications.....	3-9
3.3 Outline Dimensions .....	3-11
3.4 Troubleshooting (FAQ).....	3-12
3.5 Supported Timing List.....	3-13

# Notices

## Federal Communications Commission Statement

This device complies with Part 15 of the FCC Rules. Operation is subject to the following two conditions:

- This device may not cause harmful interference, and
- This device must accept any interference received including interference that may cause undesired operation.

This equipment has been tested and found to comply with the limits for a Class B digital device, pursuant to Part 15 of the FCC Rules. These limits are designed to provide reasonable protection against harmful interference in a residential installation. This equipment generates, uses and can radiate radio frequency energy and, if not installed and used in accordance with manufacturer's instructions, may cause harmful interference to radio communications. However, there is no guarantee that interference will not occur in a particular installation. If this equipment does cause harmful interference to radio or television reception, which can be determined by turning the equipment off and on, the user is encouraged to try to correct the interference by one or more of the following measures:

- Reorient or relocate the receiving antenna.
- Increase the separation between the equipment and receiver.
- Connect the equipment to an outlet on a circuit different from that to which the receiver is connected.
- Consult the dealer or an experienced radio/TV technician for help.



---

The use of shielded cables for connection of the monitor to the graphics card is required to assure compliance with FCC regulations. Changes or modifications to this unit not expressly approved by the party responsible for compliance could void the user's authority to operate this equipment.

---

## Canadian Department of Communications Statement

This digital apparatus does not exceed the Class B limits for radio noise emissions from digital apparatus set out in the Radio Interference Regulations of the Canadian Department of Communications.

This class B digital apparatus complies with Canadian ICES-003.

This Class B digital apparatus meets all requirements of the Canadian Interference - Causing Equipment Regulations.

Cet appareil numérique de la classe B respecte toutes les exigences du Règlement sur le matériel brouiller du Canada.



## Safety Information

- Before setting up the monitor, carefully read all the documentation that came with the package.
- To prevent fire or shock hazard, never expose the monitor to rain or moisture.
- Never try to open the monitor cabinet. The dangerous high voltages inside the monitor may result in serious physical injury.
- If the power supply is broken, do not try to fix it by yourself. Contact a qualified service technician or your retailer.
- Before using the product, make sure all cables are correctly connected and the power cables are not damaged. If you detect any damage, contact your dealer immediately.
- Slots and openings on the back or top of the cabinet are provided for ventilation. Do not block these slots. Never place this product near or over a radiator or heat source unless proper ventilation is provided.
- The monitor should be operated only from the type of power source indicated on the label. If you are not sure of the type of power supply to your home, consult your dealer or local power company.
- Use the appropriate power plug which complies with your local power standard.
- Do not overload power strips and extension cords. Overloading can result in fire or electric shock.
- Avoid dust, humidity, and temperature extremes. Do not place the monitor in any area where it may become wet. Place the monitor on a stable surface.
- Unplug the unit during a lightning storm or if it will not be used for a long period of time. This will protect the monitor from damage due to power surges.
- Never push objects or spill liquid of any kind into the slots on the monitor cabinet.
- To ensure satisfactory operation, use the monitor only with UL listed computers which have appropriate configured receptacles marked between 100-240V AC.
- If you encounter technical problems with the monitor, contact a qualified service technician or your retailer.
- Adjustment of the volume control as well as the equalizer to other settings than the center position may increase the ear-/headphones output voltage and therefore the sound pressure level.



This symbol of the crossed out wheeled bin indicates that the product (electrical, electronic equipment, and mercury-containing button cell battery) should not be placed in municipal waste. Please check local regulations for disposal of electronic products.

**AEEE yönetmeliğine uygundur**

## Care & Cleaning

- Before you lift or reposition your monitor, it is better to disconnect the cables and power cord. Follow the correct lifting techniques when positioning the monitor. When lifting or carrying the monitor, grasp the edges of the monitor. Do not lift the display by the stand or the cord.
- Cleaning. Turn your monitor off and unplug the power cord. Clean the monitor surface with a lint-free, non-abrasive cloth. Stubborn stains may be removed with a cloth dampened with mild cleaner.
- Avoid using a cleaner containing alcohol or acetone. Use a cleaner intended for use with the LCD. Never spray cleaner directly on the screen, as it may drip inside the monitor and cause an electric shock.

### **The following symptoms are normal with the monitor:**

- The screen may flicker during the initial use due to the nature of the fluorescent light. Turn off the Power Switch and turn it on again to make sure that the flicker disappears.
- You may find slightly uneven brightness on the screen depending on the desktop pattern you use.
- When the same image is displayed for hours, an afterimage of the previous screen may remain after switching the image. The screen will recover slowly or you can turn off the Power Switch for hours.
- When the screen becomes black or flashes, or cannot work anymore, contact your dealer or service center to fix it. Do not repair the screen by yourself!

## Conventions used in this guide



**WARNING:** Information to prevent injury to yourself when trying to complete a task.



**CAUTION:** Information to prevent damage to the components when trying to complete a task.



**IMPORTANT:** Information that you **MUST** follow to complete a task.



**NOTE:** Tips and additional information to aid in completing a task.

## Where to find more information

Refer to the following sources for additional information and for product and software updates.

### 1. **ASUS websites**

The ASUS websites worldwide provide updated information on ASUS hardware and software products. Refer to <http://www.asus.com>

### 2. **Optional documentation**

Your product package may include optional documentation that may have been added by your dealer. These documents are not part of the standard package.

## Takeback Services

ASUS recycling and takeback programs come from our commitment to the highest standards for protecting our environment. We believe in providing solutions for our customers to be able to responsibly recycle our products, batteries and other components as well as the packaging materials.

Please go to <http://csr.asus.com/english/Takeback.htm> for detail recycling information in different region.

## 1.1 Welcome!

Thank you for purchasing the ASUS® OLED Gaming monitor!

The latest widescreen OLED monitor from ASUS provides a crisper, broader, and brighter display, plus a host of features that enhance your viewing experience.

With these features, you can enjoy the convenience and delightful visual experience that the monitor brings to you!

## 1.2 Package Contents

Check your package for the following items:

- ✓ OLED Monitor
- ✓ Monitor Base
- ✓ Quick Start Guide
- ✓ Warranty Card
- ✓ Power Cord
- ✓ Ultra High Speed HDMI 2.1 Cable
- ✓ DP Cable
- ✓ USB Cable
- ✓ Remote Control
- ✓ Battery
- ✓ Input/Output Port Cover
- ✓ Color Calibration Testing Report
- ✓ ROG Sticker



---

If any of the above items is damaged or missing, contact your retailer immediately.

---



## 1.3 Monitor Introduction

### 1.3.1 Front View

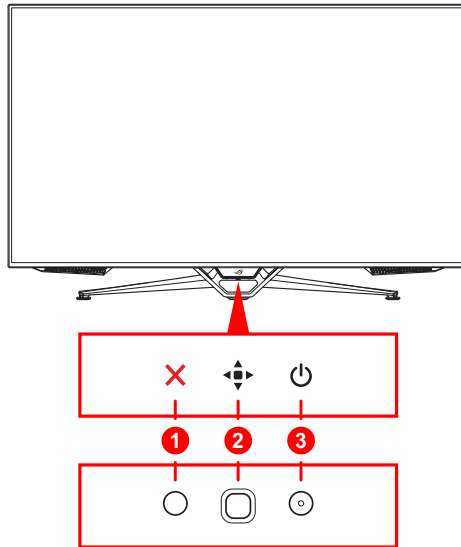

1. **X Close button:**
  - Exit the OSD menu.
  - Turn on the OSD menu when the monitor enters standby mode or display the "NO SIGNAL" message.
2. **Control buttons:**
  - Turn on the OSD menu. Enact the selected OSD menu item.
  - Increase/Decrease values or moves your selection up/down/left/right.
3. **Power button:** Turn the monitor on/off.

## 1.3.2 Back View

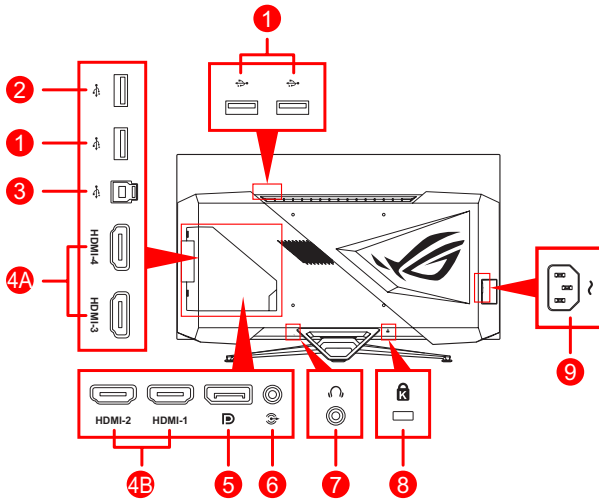

1. **USB3.2 Gen 1 downstream ports:** These ports are for connection with USB devices, such as USB keyboard/mouse, USB flash drive, etc.
2. **USB3.2 Gen 1 downstream port:** This port is for connection with USB flash drive to update the firmware.
3. **USB3.2 Gen 1 upstream port:** This port is for connection with a USB upstream cable. The connection enables the USB ports on the monitor.
4. **HDMI ports:** These ports are for connection with an HDMI compatible device.
  - **A. HDMI2.1:** These ports are for connection with an HDMI V2.1 compatible device.
  - **B. HDMI2.0:** These ports are for connection with an HDMI V2.0 compatible device.
5. **DisplayPort:** This port is for connection with a DisplayPort compatible device.
6. **SPIDIF out(Optical Digital Audio Out):** This port connects to a speaker.
7. **Earphone jack**
8. **Kensington lock slot**
9. **AC-IN port:** This port connects the power cord.

### 1.3.3 Remote Control

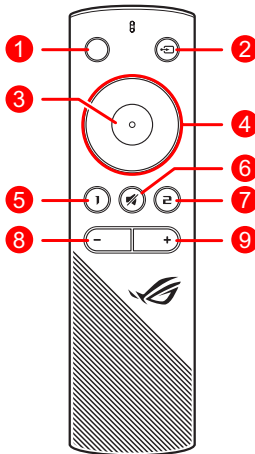

1. **Power button:** Turn the monitor on/off.
2. **Input button:** Switch the input source.
3. **Enter button:** Confirm the selection.
4. **Navigation buttons:** Increase/Decrease values or moves your selection up/down/left/right.
5. **Mute button:** Turn off the sound temporarily.
6. **Shortcut 1 button:** By default, it is GamePlus hotkey. To change the hotkey function, go to the MyFavorite > Shortcut > Shortcut1 menu.
7. **Shortcut 2 button:** By default, it is GameVisual hotkey. To change the hotkey function, go to the MyFavorite > Shortcut > Shortcut2 menu.
8. **Volume Down button:** Decrease the volume level.
9. **Volume Up button:** Increase the volume level.

For battery replacement:

Open the battery cover and install the batteries into the battery compartment. Then replace the battery cover.

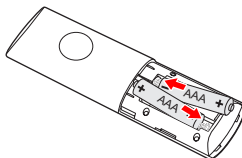

### 1.3.4 GamePlus Function

The GamePlus function provides a toolkit and creates a better gaming environment for users when playing different types of games. The crosshair overlay with 6 different crosshair options letting you choose the one that best suits the game you're playing. There are also on screen timer and stopwatch you can position on the left of the display so you can keep track of the gaming time; while the FPS (frames per second) counter lets you know how smooth the game is running. Sniper function (only available when HDR is disabled on your device) is customized for first-person shooters. You can select the magnification ratio and the type of alignment in sequence.

To activate GamePlus:

1. Press the GamePlus hotkey on the remote control.
2. Move the **Navigation** button up/down to select among different functions.
3. Press the **Enter** button or move the **Navigation** button right to confirm the function you choose, and move the **Navigation** button up/down to navigate through the settings. Move the **Navigation** button left to go back, off, or exit.
4. Highlight the desired setting and press the **Enter** button to activate it.

### GamePlus Main Menu

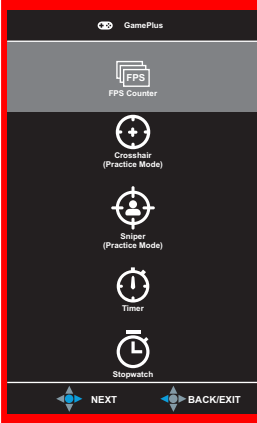

### GamePlus — FPS Counter



GamePlus — Crosshair  
(the crosshair will change color depending on the background color)

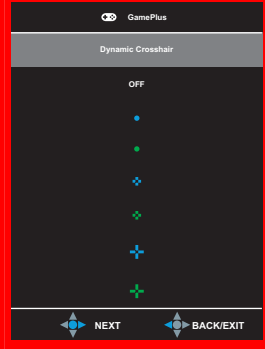

### GamePlus — Sniper



### GamePlus — Timer



### GamePlus — Stopwatch



### 1.3.5 GameVisual Function

The GameVisual function helps you select among different picture modes in a convenient way.

To activate GameVisual:

1. Press the GameVisual hotkey on the remote control.
2. Move the **Navigation** button up/down to select the desired setting.
  - **Scenery Mode:** This is the best choice for scenery photo displaying with GameVisual™ Video intelligence Technology.
  - **Racing Mode:** This is the best choice for racing game playing with GameVisual™ Video intelligence Technology.
  - **Cinema Mode:** This is the best choice for movie watching with GameVisual™ Video intelligence Technology.
  - **RTS/RPG Mode:** This is the best choice for Real-Time Strategy (RTS)/ Role-Playing Game (RPG) playing with GameVisual™ Video intelligence Technology.
  - **FPS Mode:** This is the best choice for First Person Shooter game playing with GameVisual™ Video intelligence Technology.
  - **sRGB Mode:** This is the best choice for viewing photos and graphics from PCs.
  - **MOBA Mode:** This is the best choice for Multiplayer Online Battle Arena (MOBA) games playing with GameVisual™ Video intelligence Technology.
  - **User Mode:** More items are adjustable in the Color menu.
3. Press the **Enter** button to activate it.



- 
- In the Racing Mode, the Saturation, 6-axis Saturation, and VividPixel functions are not user-configurable.
  - In the sRGB, the Saturation, Color Temp., Sharpness, 6-axis Saturation, and Contrast functions are not user-configurable. Color space will be limited on sRGB and the screen size will not affect the screen brightness.
-

## 2.1 Attaching the Stand

1. Remove the input/output port cover from the rear of the monitor. Then remove the Allen wrench from the cover.
2. Replace the input/output port cover. Then align and install the stand onto its slot.
3. Using the Allen wrench, secure the stand with the four (4) screws.

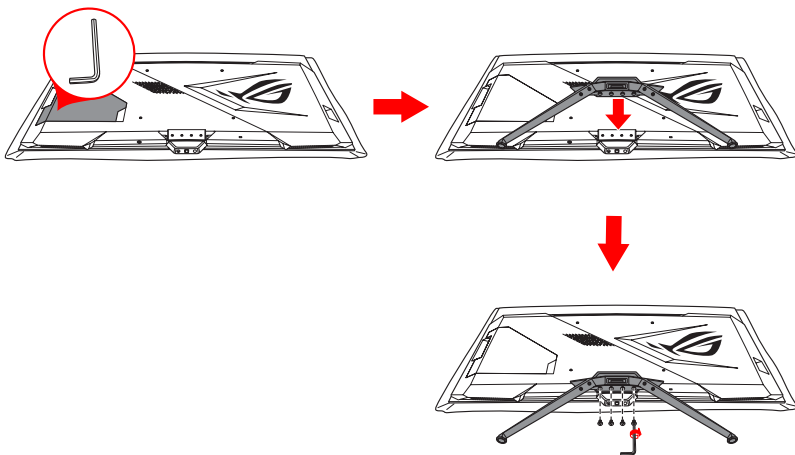

- We recommend that you cover the table surface with soft cloth to prevent damage to the monitor.

## 2.2 Cable Management

You can organize the cables with the help of the input/output port cover.

- **Arranging the cables**

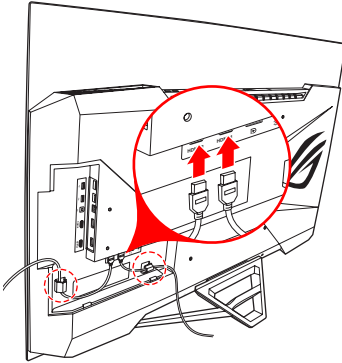

- **Using the input/output port cover:** the cover can be attached or detached.

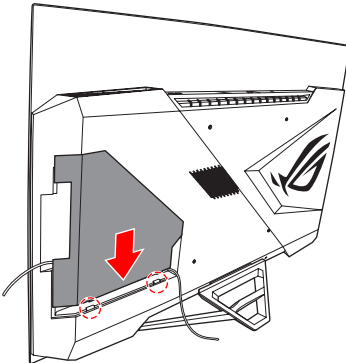



## 2.3 Detaching the Stand (for VESA wall mount)

The detachable stand of this monitor is specially designed for VESA wall mount.

1. Remove the input/output port cover from the rear of the monitor. Then remove the Allen wrench from the cover.
2. Replace the input/output port cover.
3. Using the Allen wrench, remove the four (4) screws securing the stand.
4. Remove the stand from the monitor.

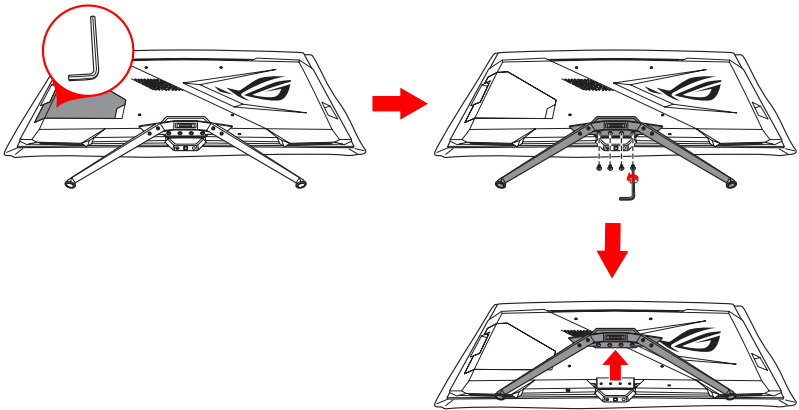

- We recommend that you cover the table surface with soft cloth to prevent damage to the monitor.



- The VESA wall mount kit (300 x 300 mm) is purchased separately.
- Use only the UL Listed Wall Mount Bracket with minimum weight/load 22.7kg (Screw size: M6 x 15 mm).

## 2.4 Connecting the Cables

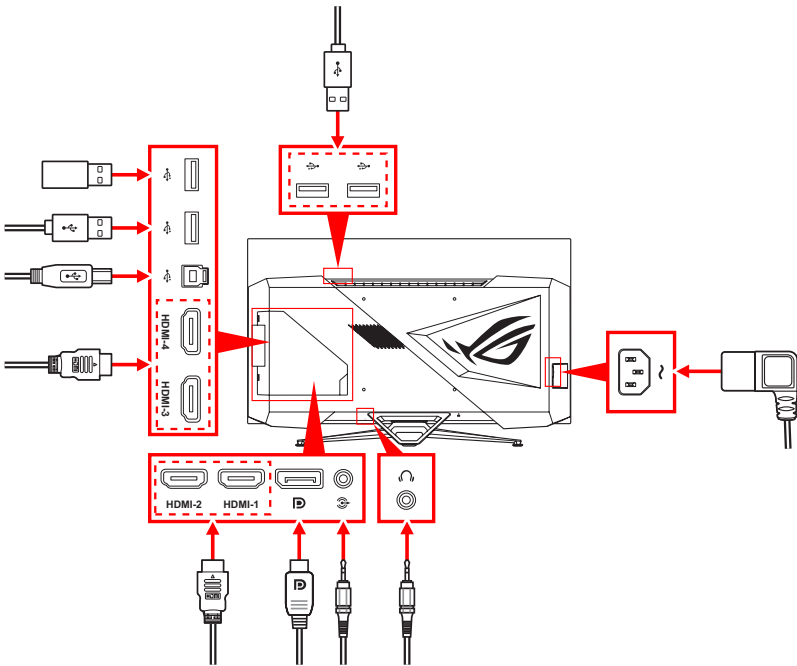

Connect the cables as the following instructions:



- **To connect the power cord:**
  - a. Connect the power adapter securely to the monitor's DC IN input.
  - b. Connect one end of the power cord to the power adapter and the other end to a power outlet.
- **To connect the DisplayPort/HDMI cable:**
  - a. Plug one end of the DisplayPort/HDMI cable to the monitor's DisplayPort/ HDMI port.
  - b. Connect the other end of the DisplayPort/HDMI cable to your computer's DisplayPort/HDMI port.
- **To connect the audio cable:** connect the speaker to the monitor's audio out port.
- **To use the earphone:** connect the end with plug type to the monitor's earphone jack.

- **To use the USB3.2 Gen 1 ports:** Take the supplied USB 3.0 cable, and plug the smaller end (type B) of the USB upstream cable to the monitor's USB upstream port, and the larger end (type A) to your computer's USB3.2 Gen 1 port. Make sure your computer is installed with the latest Windows 10/Windows 11 operating system. That will enable the USB ports on the monitor to work.
- **To use the USB3.2 Gen 1 port for firmware upgrade:** Save the new firmware to the disk drive. Then plug the disk drive to the monitor's upstream port. Follow the on-screen instructions to upgrade the firmware.

## 2.5 Turning On the Monitor

You can either press the  button on the remote control or the  button on the monitor to turn on the monitor.

If the Power Indicator function is enabled and an input source is detected, the power LED will light up red to indicate that the monitor is turned on.

The power LED will not light up in Power Saving mode.

## 3.1 OSD (On-Screen Display) Menu

### 3.1.1 How to Reconfigure

You can either use the remote control or the **Control** buttons on the monitor to navigate through the menu and make adjustments.

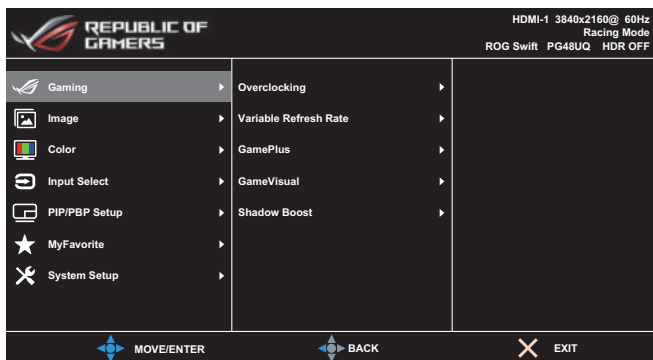

To navigate through the menu and make adjustments using the remote control, do the following:

1. Press the **Enter** button to activate the OSD menu.
2. Move the **Navigation** button up/down to navigate through the functions. Highlight the desired function and press the **Enter** button to activate it. If the function selected has a sub-menu, move the **Navigation** button up/down again to navigate through the sub-menu functions. Highlight the desired sub-menu function and press the **Enter** button or move the **Navigation** button right to activate it.
3. Move the **Navigation** button up/down to change the settings of the selected function.
4. To exit and save the OSD menu, move the **Navigation** button left repeatedly until the OSD menu disappears. To adjust other functions, repeat steps 1 to 3.

## 3.1.2 OSD Function Introduction

### 1. Gaming

Configure your gaming preferences.

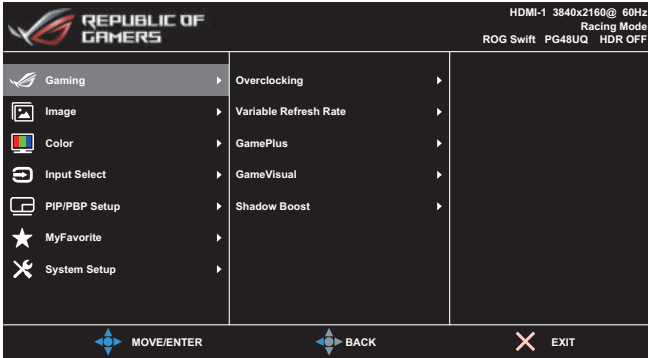

- **Overclocking:** Adjust the refresh rate.
  - **ON:** This function allows you to adjust the refresh rate.
  - **Max Refresh Rate:** Allow you to select a maximum refresh rate of 138Hz (Only for DisplayPort / HDMI1 / HDMI2 input).



Overclocking may cause screen flickering. To reduce such effects, disconnect the DisplayPort cable and use the monitor OSD menu to try again with a safer Max. Refresh rate.

- **Variable Refresh Rate:** Allow an Adaptive-Sync supported graphics source to dynamically adjust display refresh rate based on typical content frame rates for power efficient, virtually stutter free and low-latency display update.



- This function can only be activated within 48Hz~120Hz for HDMI1/HDMI2 and 48Hz~120Hz for DisplayPort.
- For supported GPUs, minimum PC system and driver requirements, please contact the GPU manufactures.

- **GamePlus:** Configure the gaming environment. See 1.3.4 GamePlus Function for details.
- **GameVisual:** Select the picture mode. See 1.3.5 GameVisual Function for details.
- **Shadow Boost:** Adjust the monitor gamma curve to enrich the dark tones in an image, making dark scenes and objects much easier to be seen.

## 2. Image

Configure the image settings.

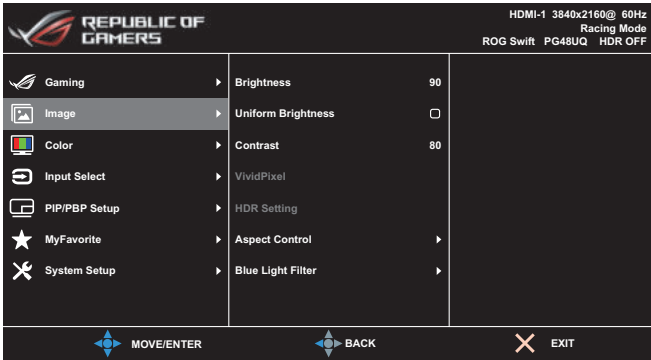

- **Brightness:** Adjust the brightness level.
- **Uniform Brightness:** With the feature enabled, the system will not adjust the maximum brightness of the screen when the screen is displayed in a different screen size.
- **Contrast:** Adjust the contrast level.
- **VividPixel:** Enhance the outline of the displayed picture and generates high-quality images on screen.
- **HDR Setting:** Set the HDR mode to ASUS Gaming HDR, ASUS Cinema HDR, or Console HDR. The HDR brightness can be adjusted when the Brightness Adjustable function is enabled.
- **Aspect Control:** Select the aspect ratio and adjust the screen position.
- **Blue Light Filter:** Reduce the energy level of blue light emitted from the LED backlight.
  - **Level 0:** No change.
  - **Level 1~4:** The higher the level, the less blue light is scattered. When Blue Light Filter is activated, the default settings of Racing Mode will be automatically imported. Between Level 1 to Level 3, the Brightness function is user-configurable. Level 4 is optimized setting. The Brightness function is not user-configurable.



The Monitor uses low blue light panel and compliance with TÜV Rheinland Low Blue Light Hardware Solution at factory reset/default setting mode (Brightness: 90%, Contrast: 80%, CCT: 6500K, Preset mode: Racing mode, Power Setting: YES).



Please refer to the following to alleviate eye strains:

- Users should take some time away from the display if working for long hours. It is advised to take short breaks (at least 5 mins) after around 1 hour of continuous working at the computer. Taking short and frequent breaks is more effective than a single longer break.
- To minimize eye strain and dryness in your eyes, users should rest the eye periodically by focusing on objects that are far away.
- Eye exercises can help to reduce eye strain. Repeat these exercises often. If eye strain continues please consult a physician. Eye exercises: (1) Repeating look up and down (2) Slowly roll your eyes (3) Move your eyes diagonal.
- High energy blue light may lead to eye strain and AMD (Age-Related Macular Degeneration). Blue light filter to reduce 70% (max.) harmful blue light to avoid CVS (Computer Vision Syndrome).

### 3. Color

Configure the image color settings.

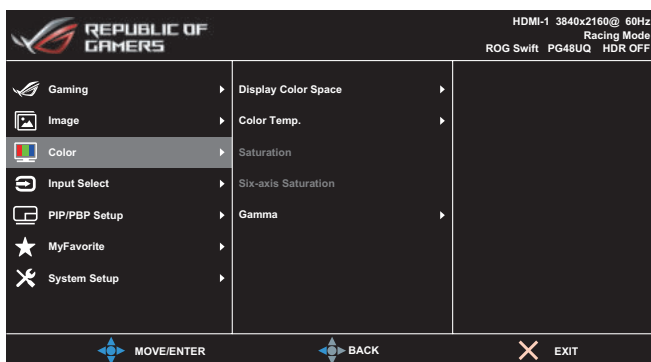

- **Display Color Space:** Select the color space for the monitor color output.
- **Color Temp.:** Select the desired color temperature.
- **Saturation:** Adjust the saturation level.
- **Six-axis Saturation:** Adjust the saturation for R, G, B, C, M, Y.
- **Gamma:** Set the color mode.

#### 4. Input Select

Select your desired input source and toggle the Auto Input Detection function between on and off. The monitor input source will not automatically switch when the Auto Input Detection function is disabled.

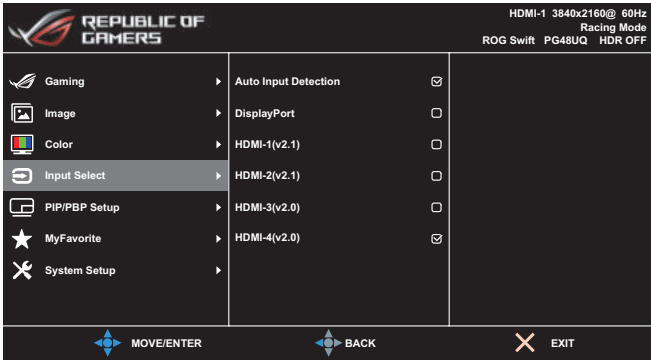

#### 5. PIP/PBP Setup

Configure the multi-picture related settings. The PBP mode cannot be enabled when the Variable Refresh Rate function is enabled.

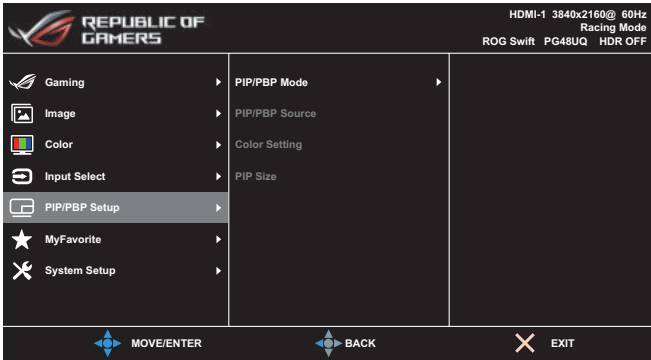

- **PIP/PBP Mode:** Enable the PIP/PBP function and select the split screen type.
- **PIP/PBP Source:** Select the video input source for the designated split screen.
- **Color Setting:** Set the GameVisual mode for the designated split screen.
- **PIP/PBP Size:** Adjust the inset window size.



This option is only available for PIP mode.



## 6. MyFavorite

Assign a function to the shortcut button, save the current system configurations, or restore the system configuration.

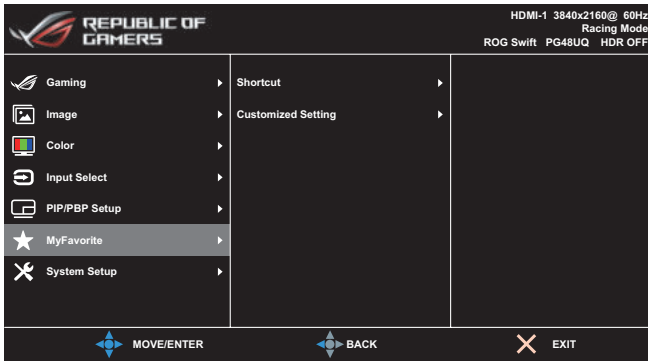

- **Shortcut:** Assign a function for the designated shortcut button.
- **Customize Setting:** Load/Save all settings on the monitor.

## 7. System Setup

Adjust the system configurations.

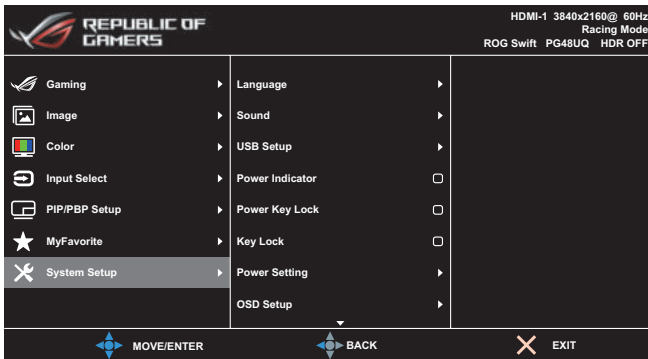

- **Language:** Select the OSD language.
- **Sound:** Configure the sound related settings.
  - **Volume:** Adjust the volume level.
  - **Mute:** Enable/Disable the mute function.
  - **Sound Source:** Select the monitor sound comes from which source.
  - **Sound Output:** Set the sound output setting to the speaker, line out, or headphone.

- **AudioWizard:** Select the sound mode.
- **USB Hub:** Sets the USB Hub availability during standby.
- **Power Indicator:** Turn the power LED indicator on/off.
- **Power Key Lock:** Disable/Enable the Power key.
- **Key Lock:** Enable this function to disable all function keys. Press the **Navigation** button down for more than five seconds to cancel the key lock function.
- **Power Setting:** Select the power setting mode. If the setting is set to **Standard Mode**, it may result in higher power consumption. On the other hand, if the setting is set to **Power Saving Mode**, it may cause limited luminance performance.

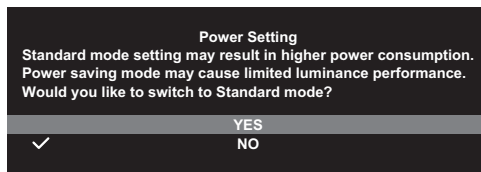

- **OSD Setup:** Configure the OSD menu related settings.
  - **OSD Position:** Set the OSD menu position.
  - **OSD Timeout:** Adjust the OSD timeout.
  - **Transparency:** Adjust the OSD background from opaque to transparent.
  - **Zoom By Remote Control:** Select the OSD menu size when using the remote control.
  - **Zoom by Hot Key:** Select the OSD menu size when using the **Control** buttons.
  - **DDC/CI:** Enable/Disable the DDC/CI function.
- **Screen Protection:** Configure the screen saver related set up. You can improve the image quality issues related to image retention when the screen is on for a certain amount of time.
  - **Screen Saver:** Enable/disable the screen saver function. The screen brightness will automatically decrease when there is no change on the screen.
  - **Pixel Cleaning:** It calibrates any issues that may arise on the screen when your monitor has been turned on for a long time. The process will take approximately 6 minutes. This function will automatically activate when the monitor is turned off. Do not unplug the power cord while it is in progress. If you power on the monitor, the Pixel Cleaning will stop operating.

- **Screen Move:** Select the screen movement level to prevent image sticking on the display panel.
- **Adjust Logo Brightness:** Enable this function to allow the system to automatically adjust the logo brightness to correct the potential picture quality issues.
- **DisplayPort Stream:** Select DisplayPort 1.2 or DisplayPort 1.4 according to the graphic card DP version.
- **DSC:** Enable/Disable the DSC (Display Stream Compression) function.
- **HDMI CEC:** Enable/Disable the HDMI CEC function. If the function is enabled, you can use the remote control to control the devices connected to the monitor through the HDMI ports.
- **Information:** Display the monitor information.
- **All Reset:** Select **YES** to revert all settings to the factory default mode.

## 3.2 Specifications

Panel type	OLED
Panel size	47.53"W (16:9, 120.7 cm) wide screen
Max. resolution	3840 x 2160
Pixel Pitch	0.274mm x 0.274mm
Brightness	135nits (Normal)(Full-White pattern) 900nits (HDR 3%)
Contrast ratio	1,500,000:1
Viewing angle (H/V)	178°/178°
Display colors	1.07 Billion colors
Response time	0.1ms
Color temperature selection	8 color temperatures
Analog input	No
Digital input	DisplayPort v1.4 x 1, HDMI v2.0 x 2, HDMI v2.1 x 2
Earphone jack	Yes
Audio output	Yes
Speaker (Built-in)	Yes
USB3.2 Gen 1 port	Upstream x 1, Downstream x 4 (5V/0.9A*2, 5V/2A*2)
Colors	Black
Power LED	Red (On) / Orange (Standby) / Blinking Orange (Pixel Cleaning)
Tilt	Forward: 5°; Backward: 4°
Swivel	No
Height adjustment	No
VESA wall mount	300 x 300 mm
Kensington lock	Yes
Voltage rating	AC 100-240V, 50/60Hz
Power consumption	Power On: < 300W Standby: < 0.5 W Power Off: < 0.3 W
Temperature (Operating)	0°C ~ 40°C
Temperature (Non-operating)	-20°C ~ +60°C
Dimensions (W x H x D)	1068 mm x 686 mm x 266 mm (With stand) 1068 mm x 612 mm x 40 mm (Without stand) 1230 mm x 180 mm x 880 mm (Package)
Weight (Esti.)	15 kg (without stand) 16.2 kg (Net) 22.7 kg (Gross)

Multi-languages	20 languages (English, French, German, Italian, Spanish, Dutch, Portuguese, Russian, Czech, Croatian, Polish, Romanian, Hungarian, Turkish, Simplified Chinese, Traditional Chinese, Japanese, Korean, Thai, Indonesian)
Accessories	DP cable, HDMI cable, USB cable, power cord, quick start guide, warranty card, input/output port cover, color calibration testing report, ROG sticker
Compliance and Standards	cTUVus, CB, CE, ErP, FCC, ICES-3, CCC, BSMI, CU, C-Tick, VCCI, PSE, J-MOSS, RoHS, WEEE, Windows 7 & 10 WHQL, KC, KCC, E-STANDBY, TUV-Flicker Free, TUV Low Blue Light, UkrSEPRO, PSB, MEPS, CE

**\*Specifications subject to change without notice.**

### 3.3 Outline Dimensions

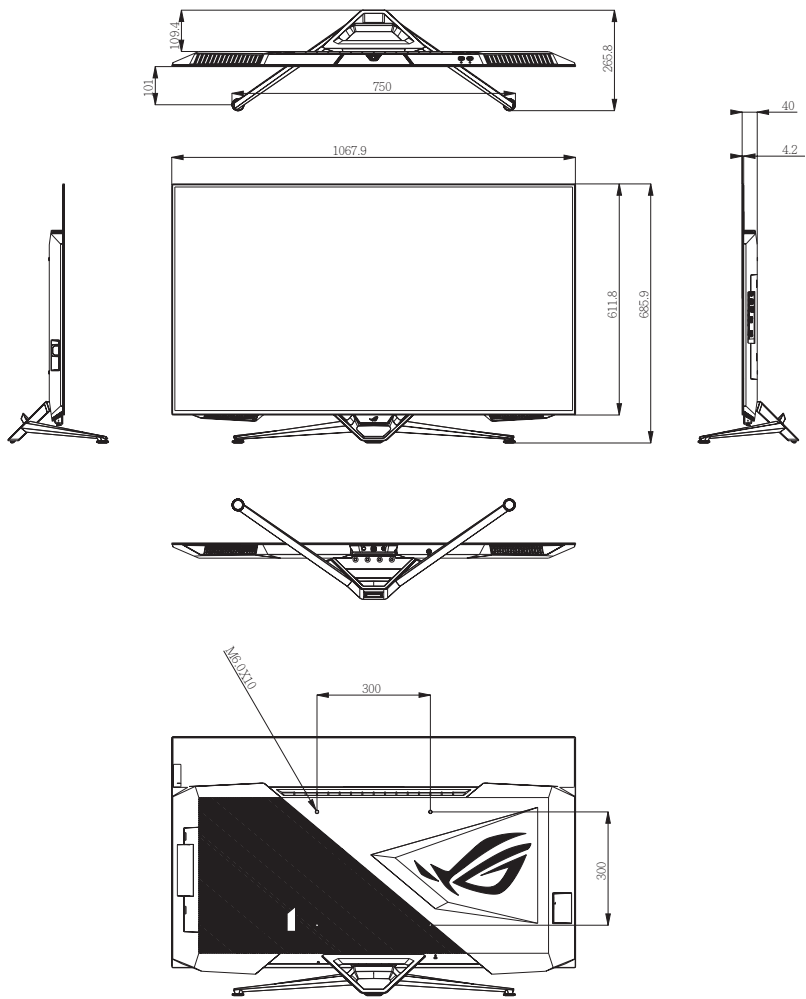

## 3.4 Troubleshooting (FAQ)

Problem	Possible Solution
Power LED is not ON	<ul style="list-style-type: none"><li>• Press the  button to check if the monitor is turned on.</li><li>• Check if the adapter and power cord are properly connected to the monitor and the power outlet.</li><li>• Check the <b>Power Indicator</b> function in the OSD menu. Select "ON" to turn on the power LED.</li></ul>
The power LED lights white and there is no screen image	<ul style="list-style-type: none"><li>• Check if the monitor and the computer are turned on.</li><li>• Make sure the signal cable is properly connected the monitor and the computer.</li><li>• Inspect the signal cable and make sure none of the pins are bent.</li><li>• Connect the computer with another available monitor to check if the computer is properly working.</li></ul>
Screen image is too light or dark	<ul style="list-style-type: none"><li>• Adjust the <b>Contrast</b> and <b>Brightness</b> settings via OSD.</li></ul>
Screen image bounces or a wave pattern is present in the image	<ul style="list-style-type: none"><li>• Make sure the signal cable is properly connected to the monitor and the computer.</li><li>• Move electrical devices that may cause electrical interference.</li></ul>
Screen image has color defects (white does not look white)	<ul style="list-style-type: none"><li>• Inspect the signal cable and make sure that none of the pins are bent.</li><li>• Perform <b>All Reset</b> via OSD.</li><li>• Select the appropriate color temperature (<b>Color Temp.</b>) via OSD.</li></ul>
HDR content is not played properly	<ul style="list-style-type: none"><li>• Make sure the input source supports HDR playback (with proper system settings and latest software).</li><li>• Make sure the content is HDR encoded.</li></ul>

### 3.5 Supported Timing List

HDMI 2.1 - HDMI1/2	HDMI 2.0 - HDMI3/4	DP
640x480@60Hz	640x480@60Hz	640x480@60Hz
640x480@75Hz	640x480@75Hz	640x480@75Hz
720x480@60Hz	720x480@60Hz	720x480@60Hz
720x576@50Hz	800x600@60Hz	720x576@50Hz
800x600@60Hz	800x600@75Hz	800x600@60Hz
800x600@75Hz	1024x768@60Hz	800x600@75Hz
1024x768@60Hz	1024x768@75Hz	1024x768@60Hz
1024x768@75Hz	1280x720@60Hz	1024x768@75Hz
1152x864@75Hz	1920x1080@60Hz	1280x720@50Hz
1280x720@60Hz	1920x1080@120Hz	1280x720@60Hz
1280x960@60Hz	1920x2160@60Hz	1280x1024@60Hz
1280x1024@60Hz	2560x1440@120Hz	1440x900@60Hz
1280x720@50Hz	3840x1600@60Hz	1680x1050@60Hz
1280x720@60Hz	3840x2160@24Hz	1920x1080@60Hz
1440x900@60Hz	3840x2160@60Hz	1920x1080@120Hz
1680x1050@60Hz		2560x1440@60Hz
1920x1080@50Hz		2560x1440@120Hz
1920x1080@60Hz		3440x1440@120Hz
1920x1080@120Hz		3840x1080@120Hz
1920x2160@60Hz		3840x1600@120Hz
2560x1440@60Hz		3840x2160@24Hz
2560x1440@120Hz		3840x2160@60Hz
3840x2160@60Hz		3840x2160@120Hz
3840x2160@120Hz		3840x2160@138Hz (overclock)
3440x1440@120Hz		
3840x1600@120Hz		
3840x2160@24Hz		
3840x1080@120Hz		
3840x2160@138Hz (overclock)		

\* Modes not listed in the table may not be supported. For optimal resolution, we recommend that you choose a mode listed in the table above.





REPUBLIC OF  
GAMERS

CE FC

