



User's Manual

FlexScan® EV3895 Color LCD Monitor

Important

Please read this "User's Manual", and "PRECAUTIONS" (separate volume) carefully to familiarize yourself with safe and effective usage.

-
- Refer to the "Setup Guide" for information on the installation / connection of the monitor.
 - For the latest product information including the "User's Manual", refer to our web site :
www.eizoglobal.com
-

Location of Caution Statement

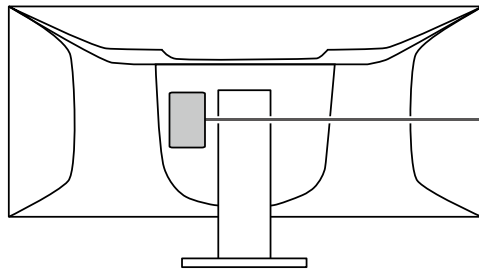

WARNING

RISK OF ELECTRIC SHOCK. DO NOT OPEN.

AVERTISSEMENT

RISQUE DE CHOC ELECTRIQUE. NE PAS OUVRIR.

WARNUNG

GEFAHR DES ELEKTRISCHEN SCHLAGES. RÜCKWAND NICHT ENTFERNEN.

警告

触电危険，请勿打开后盖。

警告

感電の恐れあり、カバーをあけないでください。

The equipment must be connected to a grounded main outlet.

L'appareil doit être relié à une prise avec terre.

Jordet stikkontakt skal benyttes når apparatet tilkobles datanett.

Apparaten skall anslutas till jordat nätuttag.

设备必须连接到接地的电源插座。

電源コードのアースは必ず接地してください。

This product has been adjusted specifically for use in the region to which it was originally shipped. If operated outside this region, the product may not perform as stated in the specifications.

No part of this manual may be reproduced, stored in a retrieval system, or transmitted, in any form or by any means, electronic, mechanical, or otherwise, without the prior written permission of EIZO Corporation. EIZO Corporation is under no obligation to hold any submitted material or information confidential unless prior arrangements are made pursuant to EIZO Corporation's receipt of said information. Although every effort has been made to ensure that this manual provides up-to-date information, please note that EIZO monitor specifications are subject to change without notice.

Notice for this monitor

About the Usage of This Product

This product is suited to general purposes like creating documents, viewing multimedia content (Assuming usage of approximately 12 hours per day).

If using this product for the following kinds of applications, where an extremely high degree of reliability and safety is required, then measures should be in place to maintain safety while using this product.

- Transportation equipment (ships, aircraft, trains, and automobiles)
 - Safety devices (Disaster prevention systems, security control systems, etc.)
 - Life-critical devices (medical devices, such as life-support devices and operating room devices)
 - Nuclear energy control devices (Nuclear energy control systems, security control systems of nuclear facilities, etc.)
 - Major system communication devices (operation control systems of transportation systems, air traffic control systems, etc.)
-

This product has been adjusted specifically for use in the region to which it was originally shipped. If the product is used outside the region, it may not operate as specified in the specifications.

This product may not be covered by warranty for uses other than those described in this manual.

The specifications noted in this manual are only applicable when the following are used:

- Power cords provided with the product
 - Signal cables specified by us
-

Only use optional products manufactured or specified by us with this product.

About the LCD Panel

It takes about 30 minutes (under our measurement conditions) for the monitor display to stabilize. Please wait 30 minutes or more after the monitor power has been turned on, and then adjust the monitor.

Monitors should be set to a lower brightness to prevent a loss in the screen quality caused by long-term use and to maintain stable use.

When the screen image is changed after displaying the same image for extended periods of time, an afterimage may appear. Use the screen saver or power save function to avoid displaying the same image for extended periods of time. Depending on the image, an afterimage may appear even if it was displayed for a short period of time. To remove such a phenomenon, change the image or keep the power turned off for several hours.

If the monitor displays continuously over a long period of time, dark smudges or burn-in may appear. To maximize the life of the monitor, we recommend the monitor be turned off periodically.

The LCD panel is manufactured using high-precision technology. Although, missing pixels or lit pixels may appear on the LCD panel, this is not a malfunction. Percentage of effective dots: 99.9994 % or higher.

The backlight of the LCD panel has a fixed lifetime. Depending on the usage pattern, such as usage for long continuous periods, the lifespan of the backlight may run out sooner, requiring replacement. When the screen becomes dark or begins to flicker, please contact your local EIZO representative.

Do not press on the LCD panel or edge of the frame strongly, as this may result in display malfunctions, such as interference patterns, etc. If pressure is continuously applied to the LCD panel surface, the liquid crystal may deteriorate or the LCD panel may be damaged. (If the pressure marks remain on the panel, leave the monitor with a black or white screen. The symptom may disappear.)

Do not scratch or press on the LCD panel with any sharp objects, at this may result in damage to the LCD panel. Do not attempt to brush with tissues as this may scratch the panel.

About the Installation

If you place this product on a lacquer-coated desk, the color may adhere to the bottom of the stand due to the composition of the rubber. Check the desk surface before use.

When the monitor is cold and brought into a room or the room temperature goes up quickly, dew condensation may occur on the interior and exterior surfaces of the monitor. In that case, do not turn the monitor on. Instead wait until the dew condensation disappears, otherwise it may cause some damage to the monitor.

About the Maintenance

Periodic cleaning is recommended to keep the monitor looking new and to prolong its operation lifetime (refer to [“Cleaning” \(page 4\)](#)).

Cleaning

The stains on the cabinet and LCD panel surface can be removed by moistening part of a soft cloth with water or by using ScreenCleaner (available as an option).

Attention

- Chemicals such as alcohol and antiseptic solution may cause gloss variation, tarnishing, and fading of the cabinet or LCD panel, and also quality deterioration of the image.
 - Never use thinner, benzine, wax, or abrasive cleaner as they may damage the cabinet or LCD panel surface.
-

To use the monitor comfortably

- An excessively dark or bright screen may affect your eyes. Adjust the brightness of the monitor according to the environmental conditions.
- Staring at the monitor for a long time tires your eyes. Take a 10-minute rest every hour.

CONTENTS

Notice for this monitor	3	Chapter 5 Administrator Settings.....	32
Cleaning	4	5-1. Basic Operation of the “Administrator Settings” Menu.....	32
To use the monitor comfortably	4	5-2. Functions of the “Administrator Settings” Menu.....	33
CONTENTS.....	5	Chapter 6 Troubleshooting.....	35
Chapter 1 Introduction.....	6	6-1. No Picture	35
1-1. Features	6	6-2. Imaging Problems.....	37
● Curved Monitor.....	6	6-3. Other Problems	38
● Free Layout	6	Chapter 7 Attaching/Removing the Stand	40
● Linking the Input Signal and USB Port	6	7-1. Removing the Stand	40
● Docking Station Function	6	7-2. Attaching the Optional Arm.....	41
● Support for DisplayPort Alt Mode / USB Power Delivery	7	7-3. Attaching the original stand.....	42
● Reduction of Power Consumption	7	Chapter 8 Reference	43
● Realizing More Convenient Operations Using Screen InStyle	8	8-1. Using the Docking Station Function	43
1-2. Controls and Functions	8	● Connection Procedure	43
● Front	8	8-2. Specifications	45
● Rear.....	9	● Accessories.....	46
1-3. Supported Resolutions	10	Appendix.....	47
● DisplayPort.....	10	Trademark	47
● HDMI	11	License	47
● USB-C.....	12		
Chapter 2 Basic Adjustment / Setting	13		
2-1. Switch Operation Method	13		
2-2. Switching Input Signals	14		
2-3. Switching Display Modes (Color Modes)...14			
● Display Modes.....	14		
2-4. Adjusting Brightness	15		
2-5. Adjusting Volume.....	15		
Chapter 3 Advanced Adjustment / Setting	16		
3-1. Basic Operation of the Setting Menu	16		
3-2. Setting Menu Functions	17		
● Color Adjustment.....	17		
● Signal Settings	20		
● Preference Settings	22		
● EcoView Settings	24		
● Language	25		
● Information	25		
Chapter 4 Connecting Multiple PCs	26		
4-1. Connecting Multiple PCs	26		
● Connection examples	26		
4-2. Using PbyP Display	27		
● PbyP Settings.....	27		
● Swapping the Main Window of Three Window Display.....	29		
4-3. Linking the Input Signal and USB Port	30		
● Connection Example.....	30		

Chapter 1 Introduction

Thank you very much for choosing an EIZO color LCD monitor.

1-1. Features

● Curved Monitor

This monitor comes equipped with a curved LCD panel with a resolution of 3840 x 1600. Two windows can be aligned side-by-side for seamless display.

● Free Layout

This monitor comes equipped with a PbyP (Picture by Picture) function that can display multiple input signals at the same time. Three window Picture by Picture (3 PbyP) display and two window Picture by Picture (2 PbyP) display are possible.

When using three window Picture by Picture (3 PbyP) display, you can swap the main window by selecting the operation switch () on the front of the monitor. (page 29)

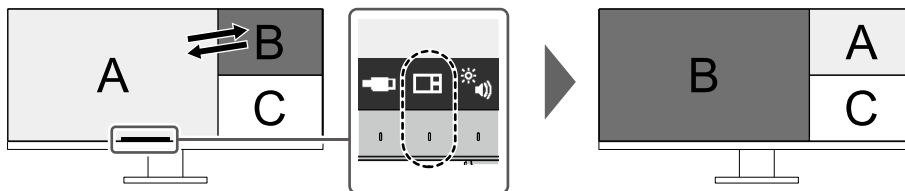

● Linking the Input Signal and USB Port

When two or three PCs are connected to one monitor, you can link the input signals with the USB upstream ports. This allows you to use a USB device connected to the monitor from multiple PCs by switching between them.

Select the operation switch () on the front of the monitor to swap to an enabled USB upstream port. (page 31)

● Docking Station Function

This product is equipped with a LAN port and USB hub so that it can be used as a docking station. By connecting a USB Type-C® (hereinafter USB-C®) cable, you can create a stable network environment even on notebook PCs or tablet devices that are not equipped with LAN ports. You can also use USB-compatible peripheral devices and charge smartphones. (page 43)

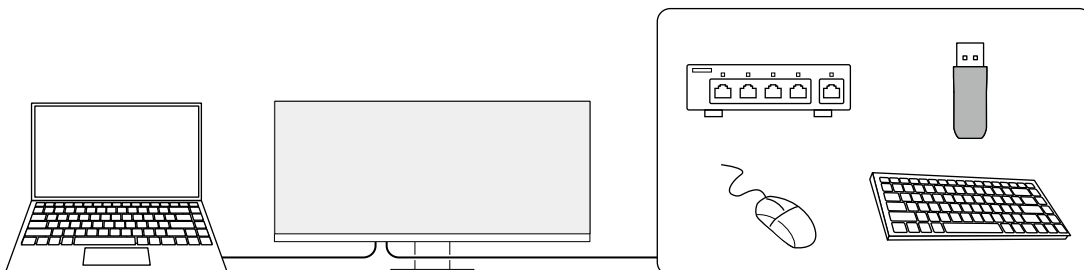

● Support for DisplayPort Alt Mode / USB Power Delivery

This product is equipped with a USB-C connector and supports the transmission of video signals (DisplayPort Alt Mode) as well as the charging of USB devices (USB Power Delivery). It supplies a maximum of 85 W of power to a connected notebook PC when used as an external monitor.

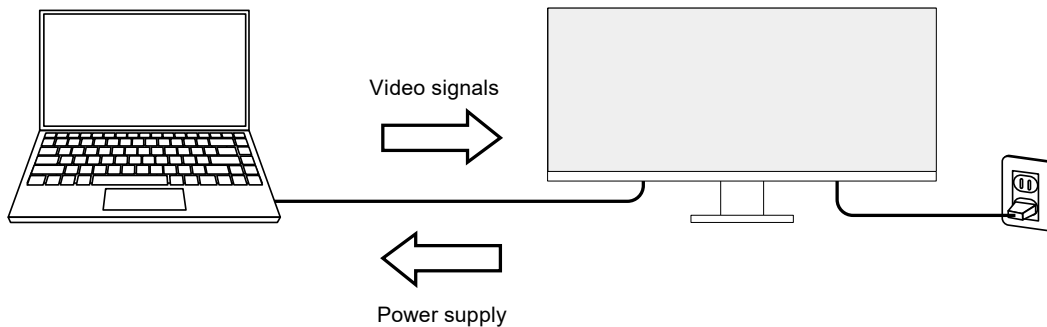

Note

- To use the charging function, the connected device must support device charging by using USB Power Delivery. Charging may not be possible depending on the connected external device.
- Only when one of the following USB-C cables is used, a maximum power of 85 W can be supplied.
 - CC200SS-5A or CC200SSW-5A (Included)
 - CC100 (Separately sold accessory)
- To display video signals, the connected device must support DisplayPort over USB Type-C (DisplayPort Alt Mode).
- Connected devices can be charged even when the monitor is in power saving mode.
- When "Compatibility Mode" is set to "On" in the "Administrator Settings" menu, connected devices can be charged even when the power of the monitor is turned off.

● Reduction of Power Consumption

This product provides a function that automatically adjusts the screen brightness to reduce power consumption ^{*1}. Power Reduction, CO₂ Reduction, and Eco Performance Level can be checked on the "EcoView Settings" menu. (page 24)

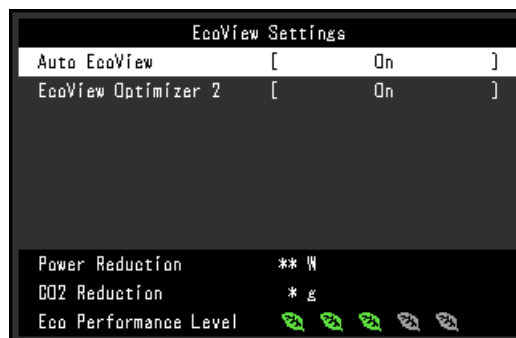

- Auto EcoView
The ambient light sensor on the front of the monitor detects the ambient brightness to automatically adjust the screen brightness to a comfortable level.
- EcoView Optimizer 2
The monitor automatically adjusts the screen brightness according to the white level of the input signal. This function can reduce power consumption while maintaining the brightness specified by the input signal.

*1 Reference values

Maximum power consumption: 194 W (when a USB device is connected and the speakers are working), standard power consumption: 28 W (brightness 120 cd/m², when no USB device is connected and the speakers are not working, at default settings)

● Realizing More Convenient Operations Using Screen InStyle

The "Screen InStyle" monitor control utility enables you to use the monitor more conveniently.

- The monitor color mode can be switched automatically to suit the software to be used.
- You can switch input signals using the shortcut keys on the keyboard.
- When multiple monitors are installed, you can turn the power on and off or change the color mode of all monitors at the same time.

Note

- Screen InStyle can be downloaded from our web site (www.eizoglobal.com).
 - The Windows operating systems are only supported.
-

1-2. Controls and Functions

● Front

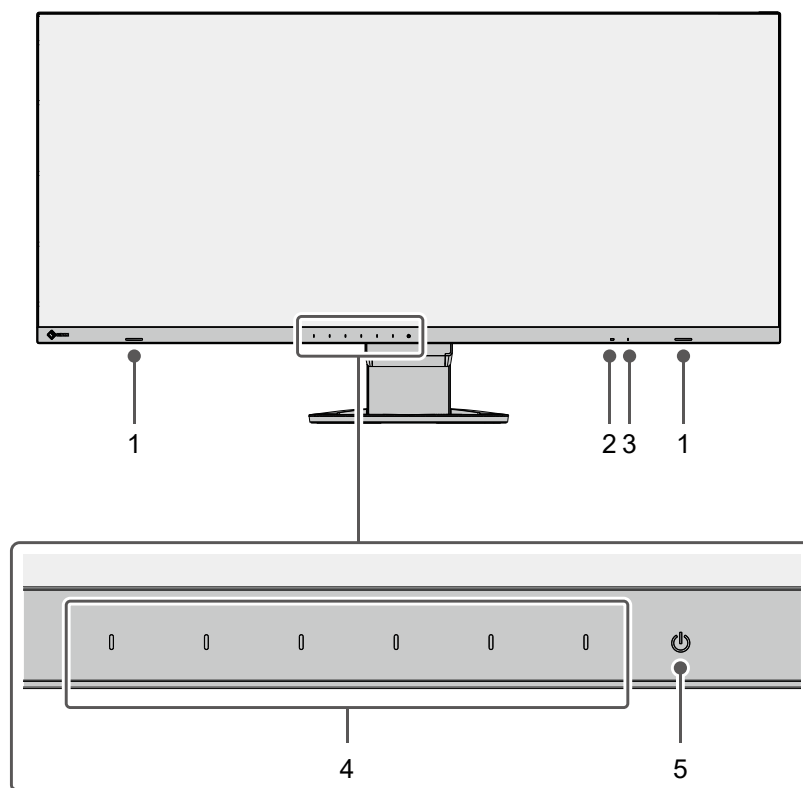

1. Speakers	Outputs audio.
2. Ambient light sensor	Detects ambient brightness. If you use Auto EcoView, the screen brightness is automatically adjusted according to the ambient brightness (page 24).
3. Power indicator	Indicates the monitor's operation status. White: Normal operation mode Orange: Power saving mode OFF: Main power / power off
4. Operation switches	Displays menus. Operate the switches according to the operation guide (page 16).
5. Power switch	Turns the power on or off.

● Rear

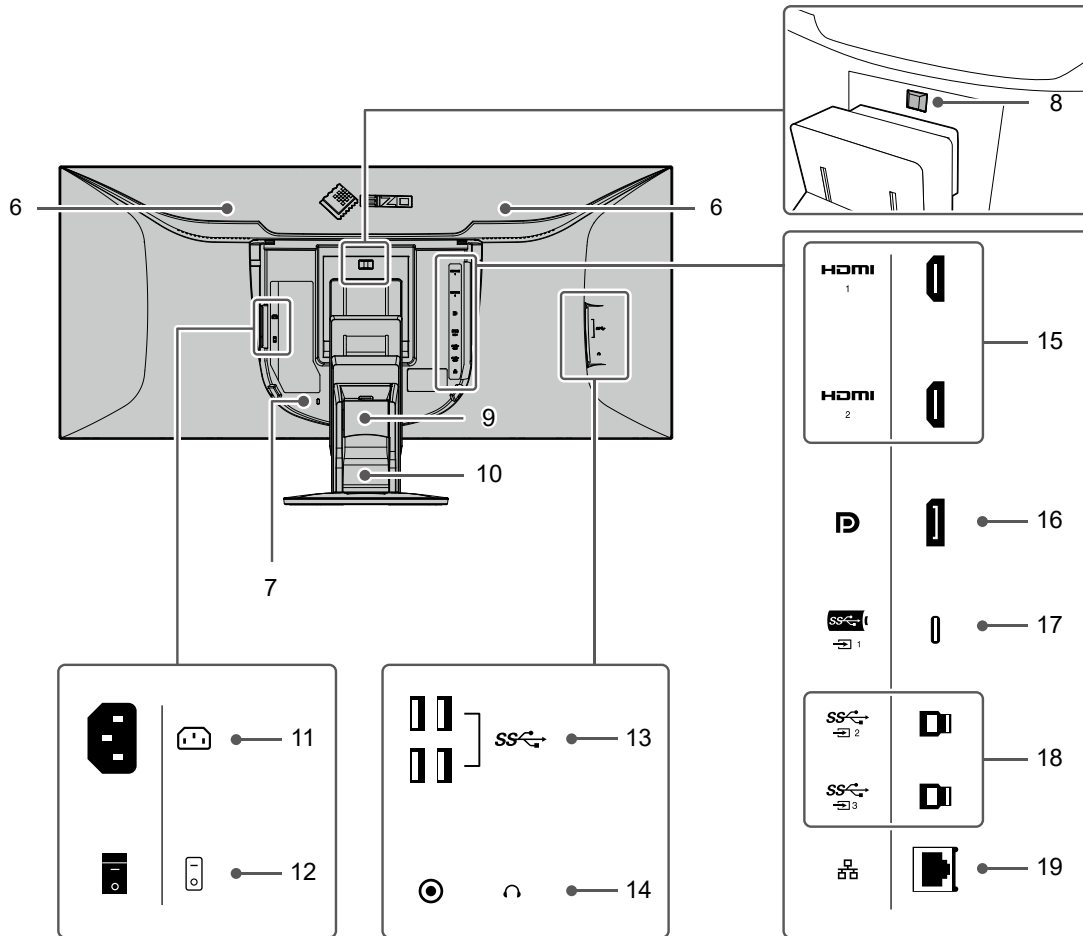

6. Handle	This handle is used for transportation.
7. Security lock slot	Complies with Kensington's MicroSaver security system.
8. Lock button	Use this button to remove the monitor from the stand.
9. Cable holder	Stores the cables.
10. Stand^{*1}	Adjusts the height and angle (tilt and swivel) of the monitor.
11. Power connector	Connects the power cord.
12. Main power switch	Turns the main power on or off. : On, ○ : Off
13. USB-A connector (downstream)	Connects to a peripheral USB device (page 43).
14. Headphone jack	Connects to headphones.
15. HDMI connector	Connects to a PC with HDMI output.
16. DisplayPort connector	Connects to a PC with DisplayPort output.
17. USB-C connector (upstream)	Connects to a PC with USB-C output. This also transmits the USB signal that is necessary for using software that requires USB connection or when using the docking station function (page 43).
18. USB-B connector (upstream)	Connect the USB cable when using software that requires USB connection. This makes it possible to connect USB devices such as a mouse or keyboard to the monitor and use them from multiple PCs.
19. LAN port (RJ-45)	When using a network connection with the docking station function (page 43), this connects to a network hub or router with a LAN cable.

^{*1} By removing the stand from the monitor, it is possible to attach the monitor to a different stand or arm.

1-3. Supported Resolutions

The monitor supports the following resolutions.

● DisplayPort

Two window display (2 PbyP)

Layout 1

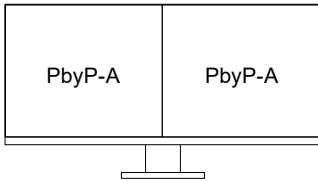

Layout 2

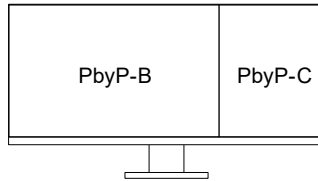

Layout 3

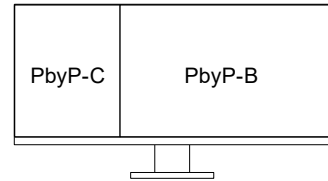

Three window display (3 PbyP)

Layout 1

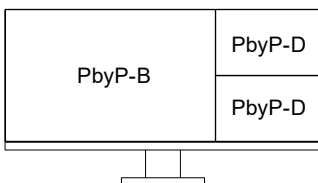

Layout 2

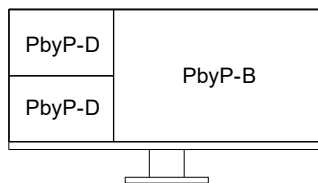

Layout 3

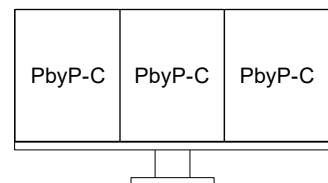

Resolution	Vertical Scan Frequency (Hz)	Scan Format	Single Window Display ^{*1}		PbyP Display			
			Version 1.1	Version 1.2	PbyP-A	PbyP-B	PbyP-C	PbyP-D
640 × 480	59.940	Progressive	√	√	√	√	√	√
640 × 480	60.000	Progressive	√	√	√	√	√	√
720 × 400	70.087	Progressive	√	√	√	√	√	√
720 × 480	59.940	Progressive	√	√	√	√	√	√
720 × 480	59.941	Progressive	√	√	√	√	√	√
720 × 480	60.000	Progressive	√	√	√	√	√	√
800 × 600	60.317	Progressive	√	√	√	√	√	√
1024 × 768	60.004	Progressive	√	√	√	√	√	√
1280 × 720	59.855	Progressive	√	√	√	√	√	√
1280 × 720	59.940	Progressive	√	√	√	√	√	√
1280 × 720	59.979	Progressive	√	√	√	√	√	√
1280 × 720	60.000	Progressive	√	√	√	√	√	√
1280 × 800	59.810	Progressive	√	√	√	√	√	√ ^{*4}
1280 × 800	59.910	Progressive	√	√	√	√	√	√ ^{*4}
1280 × 1024	60.020	Progressive	√	√	√	√	√	√ ^{*3}
1280 × 1600	59.910	Progressive	-	-	-	-	√ ^{*2}	-
1600 × 900	60.000	Progressive	√	√	√	-	-	-
1600 × 1200	60.000	Progressive	√	√	√	-	-	-
1680 × 1050	59.883	Progressive	√	√	√	-	-	-
1680 × 1050	59.954	Progressive	√	√	√	-	-	-
1920 × 1080	59.940	Progressive	√	√	√	√	-	√ ^{*3}
1920 × 1080	60.000	Progressive	√	√	√	√	-	√ ^{*3}
1920 × 1600	59.950	Progressive	-	-	√ ^{*2}	-	-	-
2560 × 1600	59.972	Progressive	√	√	-	√ ^{*2}	-	√ ^{*2 *3}
3840 × 1600	29.998	Progressive	√ ^{*2}	√	-	-	-	-
3840 × 1600	59.994	Progressive	-	√ ^{*2}	-	-	-	-

*1 The applicable signal varies depending on the "Signal Format" settings (refer to "Signal Format" (page 34))

*2 Recommended resolution

*3 Displayed at reduced size

*4 Native resolution of the display area

● HDMI

Two window display (2 PbyP)

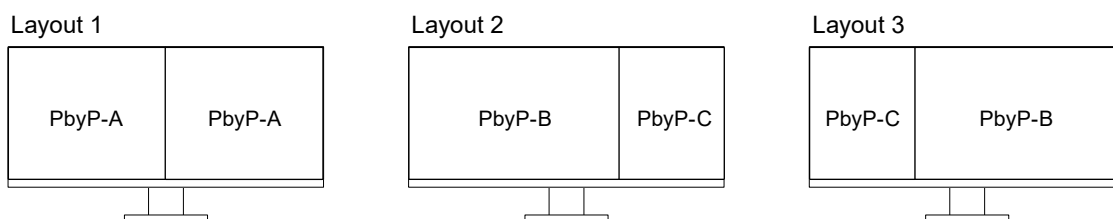

Three window display (3 PbyP)

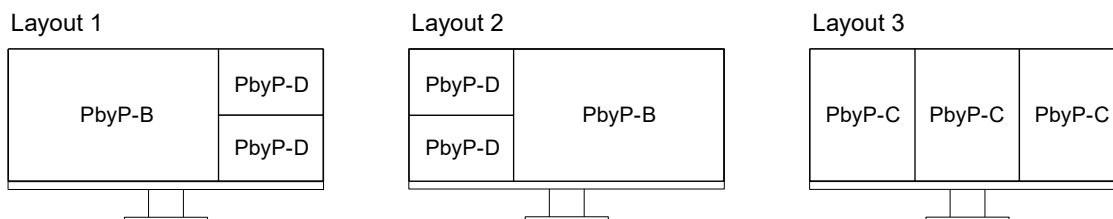

Resolution	Vertical Scan Frequency (Hz)	Scan Format	Single Window Display ^{*1}		PbyP Display			
			WQHD+ 60Hz	WQHD+ 30Hz	PbyP-A	PbyP-B	PbyP-C	PbyP-D
640 × 480	59.940	Progressive	√	√	√	√	√	√
640 × 480	60.000	Progressive	√	√	√	√	√	√
720 × 400	70.087	Progressive	√	√	√	√	√	√
720 × 480	59.940	Progressive	√	√	√	√	√	√
720 × 480	59.941	Progressive	√	√	√	√	√	√
720 × 480	60.000	Progressive	√	√	√	√	√	√
720 × 576	50.000	Progressive	√	√	√	√	√	√
800 × 600	60.317	Progressive	√	√	√	√	√	√
1024 × 768	60.004	Progressive	√	√	√	√	√	√
1280 × 720	50.000	Progressive	√	√	√	√	√	√
1280 × 720	59.855	Progressive	√	√	√	√	√	√
1280 × 720	59.940	Progressive	√	√	√	√	√	√
1280 × 720	59.979	Progressive	√	√	√	√	√	√
1280 × 720	60.000	Progressive	√	√	√	√	√	√
1280 × 800	59.810	Progressive	√	√	√	√	√	√ ^{*4}
1280 × 800	59.910	Progressive	√	√	√	√	√	√ ^{*4}
1280 × 1024	60.020	Progressive	√	√	√	√	√	√ ^{*3}
1280 × 1600	59.910	Progressive	-	-	-	-	√ ^{*2}	-
1600 × 900	60.000	Progressive	√	√	√	-	-	-
1600 × 1200	60.000	Progressive	√	√	√	-	-	-
1680 × 1050	59.883	Progressive	√	√	√	-	-	-
1680 × 1050	59.954	Progressive	√	√	√	-	-	-
1920 × 1080	50.000	Progressive	√	√	√	√	-	√ ^{*3}
1920 × 1080	59.940	Progressive	√	√	√	√	-	√ ^{*3}
1920 × 1080	59.940	Interlace	√	√	√	√	-	√ ^{*3}
1920 × 1080	60.000	Progressive	√	√	√	√	-	√ ^{*3}
1920 × 1080	60.000	Interlace	√	√	√	√	-	√ ^{*3}
1920 × 1600	59.950	Progressive	-	-	√ ^{*2}	-	-	-
2560 × 1600	59.972	Progressive	√	√	-	√ ^{*2}	-	√ ^{*2 *3}
3840 × 1600	29.998	Progressive	√	√ ^{*2}	-	-	-	-
3840 × 1600	59.994	Progressive	√ ^{*2}	-	-	-	-	-

*1 The applicable signal varies depending on the "Signal Format" settings (refer to "Signal Format" (page 34))

*2 Recommended resolution

*3 Displayed at reduced size

*4 Native resolution of the display area

● USB-C

Two window display (2 PbyP)

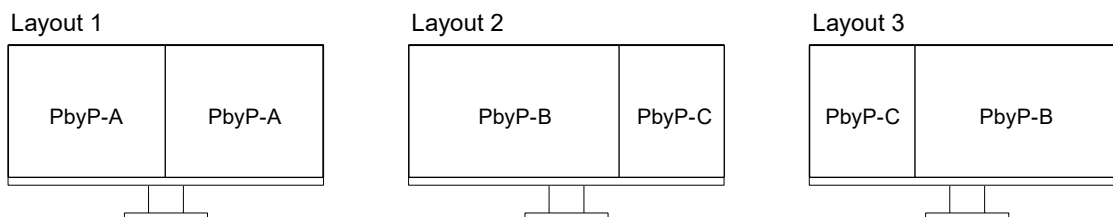

Three window display (3 PbyP)

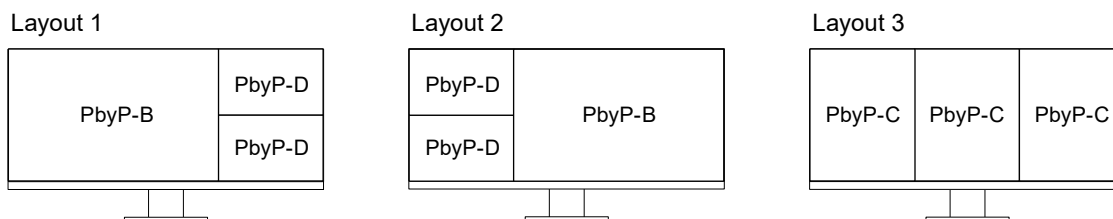

Resolution	Vertical Scan Frequency (Hz)	Scan Format	Single Window Display ^{*1}		PbyP Display			
			WQHD+ 60Hz / USB2.0	WQHD+ 30Hz / USB3.1	PbyP-A	PbyP-B	PbyP-C	PbyP-D
640 × 480	59.940	Progressive	√	√	√	√	√	√
640 × 480	60.000	Progressive	√	√	√	√	√	√
720 × 400	70.087	Progressive	√	√	√	√	√	√
720 × 480	59.940	Progressive	√	√	√	√	√	√
720 × 480	59.941	Progressive	√	√	√	√	√	√
720 × 480	60.000	Progressive	√	√	√	√	√	√
800 × 600	60.317	Progressive	√	√	√	√	√	√
1024 × 768	60.004	Progressive	√	√	√	√	√	√
1280 × 720	59.855	Progressive	√	√	√	√	√	√
1280 × 720	59.940	Progressive	√	√	√	√	√	√
1280 × 720	59.979	Progressive	√	√	√	√	√	√
1280 × 720	60.000	Progressive	√	√	√	√	√	√
1280 × 800	59.810	Progressive	√	√	√	√	√	√ ^{*4}
1280 × 800	59.910	Progressive	√	√	√	√	√	√ ^{*4}
1280 × 1024	60.020	Progressive	√	√	√	√	√	√ ^{*3}
1280 × 1600	59.910	Progressive	-	-	-	-	√ ^{*2}	-
1600 × 900	60.000	Progressive	√	√	√	-	-	-
1600 × 1200	60.000	Progressive	√	√	√	-	-	-
1680 × 1050	59.883	Progressive	√	√	√	-	-	-
1680 × 1050	59.954	Progressive	√	√	√	-	-	-
1920 × 1080	59.940	Progressive	√	√	√	√	-	√ ^{*3}
1920 × 1080	60.000	Progressive	√	√	√	√	-	√ ^{*3}
1920 × 1600	59.950	Progressive	-	-	√ ^{*2}	-	-	-
2560 × 1600	59.972	Progressive	√	√	-	√ ^{*2}	-	√ ^{*2} * ^{*3}
3840 × 1600	29.998	Progressive	√	√ ^{*2}	-	-	-	-
3840 × 1600	59.994	Progressive	√ ^{*2}	-	-	-	-	-

*1 The applicable signal varies depending on the "Signal Format" settings (refer to "Signal Format" (page 34))

*2 Recommended resolution

*3 Displayed at reduced size

*4 Native resolution of the display area

Chapter 2 Basic Adjustment / Setting

The input signals and display modes of this monitor can be switched according to your usage environment and preferences.

This chapter describes the basic functions that can be adjusted and set using the switches on the front of the monitor.

For advanced adjustment and setting procedures using the Setting menu, see “[Chapter 3 Advanced Adjustment / Setting](#)” (page 16).

2-1. Switch Operation Method

1. Displaying the operation guide

1. Touch any switch (except .

The operation guide appears on the screen.

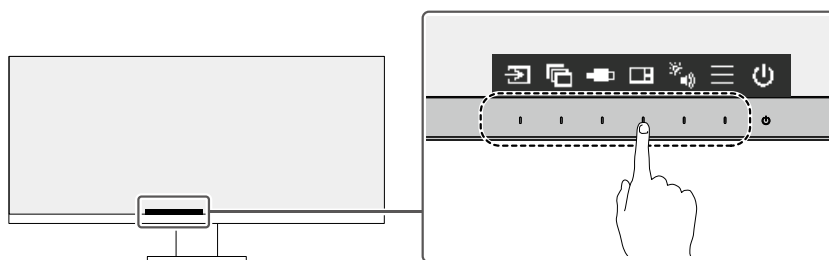



Note

- Do not directly touch the operation guide that appears on the screen. There are switches below the operation guide that can be touched to perform adjustment / setting.

2. Adjusting / setting

1. Touch a switch for adjustment / setting.

The Adjustment / Setting menu appears.

(A submenu may also be displayed. In this case, select the item for adjustment / setting using   and select .

2. Perform adjustment / setting with the switches and select  to accept the changes.

3. Exiting

1. Select  to exit the menu.

2-2. Switching Input Signals

When a monitor has multiple signal inputs, the signal to display on-screen can be changed.

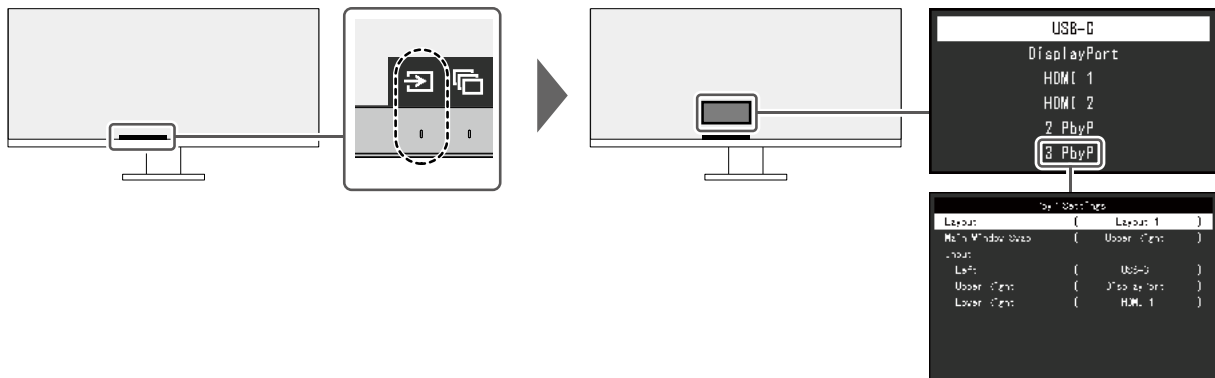

For details on PbyP, see “4-2. Using PbyP Display” (page 27).

Note

- "Screen InStyle" allows you to switch input signals using the shortcut keys on the keyboard.

2-3. Switching Display Modes (Color Modes)

This product is preinstalled with color modes for various display purposes.

By switching the mode according to the purpose and contents of the display, you can display images in an appropriate manner.

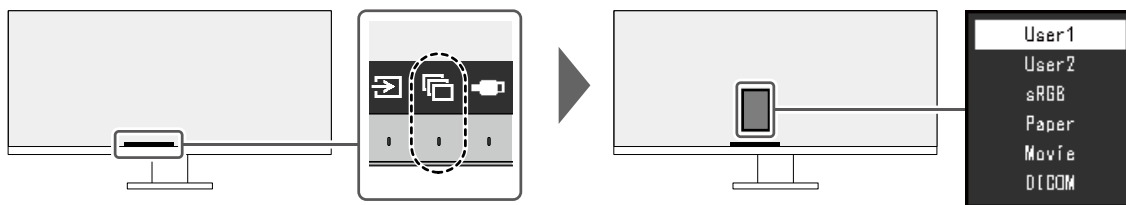

● Display Modes

Color Mode	Purpose
User1 User2	Select either of these modes to set a user-defined display mode.
sRGB	Select this mode to display colors in the sRGB color gamut on Windows (unnecessary for macOS). Note • This product is equipped with an LCD panel that has a wider color gamut than sRGB.
Paper	This mode uses color tones and contrast similar to that of paper to produce a printed paper effect. It is suitable for displaying images from media such as books and documents.
Movie	This mode displays moving images brightly and with a clear-cut three-dimensional appearance. It is suitable for playing back video content.
DICOM	Select this mode to simply display medical purpose digital images based on DICOM® Part 14. Attention • This is not intended to be used for diagnostic purposes.

Note

- "Screen InStyle" allows you to select the color mode automatically according to the software in use.
- In Paper mode, the amount of blue light emitted from the screen is reduced by changing the color tone and controlling the brightness.

2-4. Adjusting Brightness

The brightness of the screen can be adjusted to suit the installation environment or personal preference. The screen brightness is adjusted by changing the brightness of the backlight (light source from the LCD back panel).

Setting Value

0 to 100

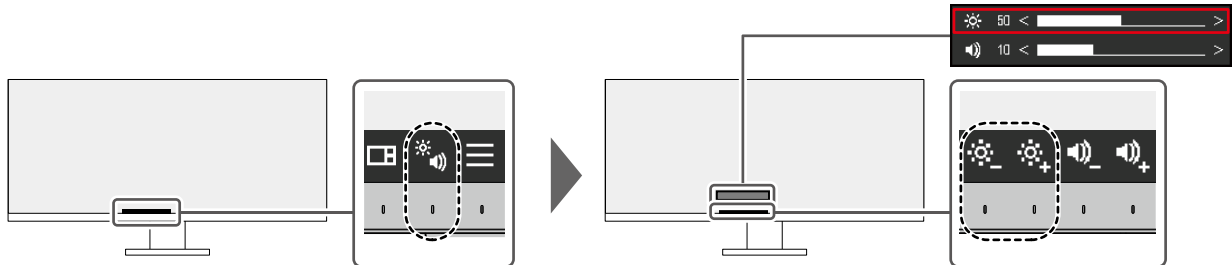

2-5. Adjusting Volume

The volume of the speakers and headphones can be set individually.

Setting Value

0 to 30

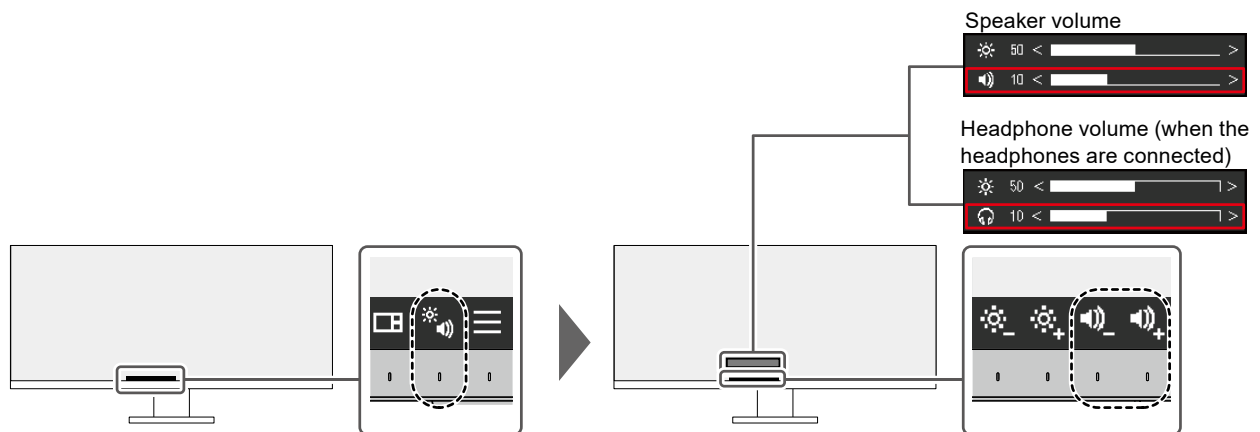



Chapter 3 Advanced Adjustment / Setting

This chapter describes the advanced monitor adjustment and setting procedures using the Setting menu. For basic functions, see “Chapter 2 Basic Adjustment / Setting” (page 13).



3-1. Basic Operation of the Setting Menu

1. Menu display

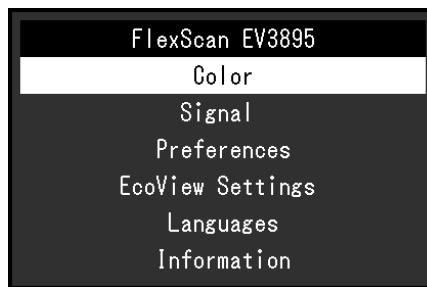

1. Touch any switch (except )
The operation guide appears.
2. Select 
The Setting menu appears.





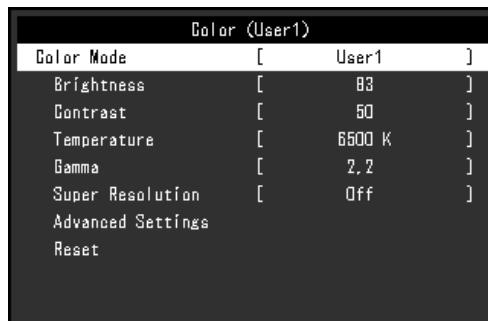



2. Adjusting / setting

1. Select a menu to adjust / set with   and select 
The Sub menu appears.



2. Select an item to adjust / set with   and select 
The Adjustment / Setting menu appears.



3. Perform adjustment / setting with   or   and select  to accept the changes.
The Sub menu appears.
Selecting  during adjustment / setting will cancel the adjustment / setting and restore the state prior to making changes.

3. Exiting

1. Selecting  several times will terminate the Setting menu.

3-2. Setting Menu Functions

● Color Adjustment

The color mode settings can be adjusted according to personal preference.

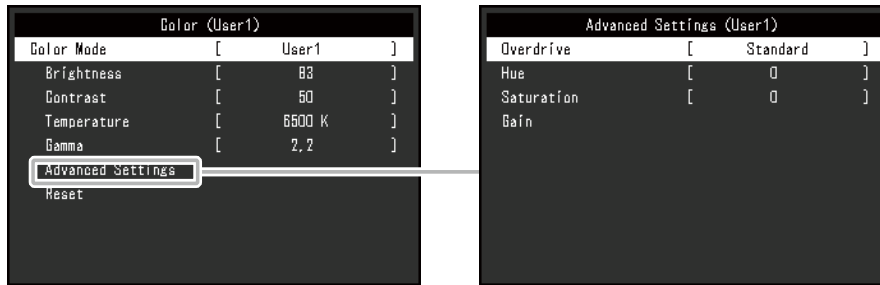

Functions that can be adjusted differ depending on the color mode.

√: Adjustable - : Not adjustable

Function	Color Mode				
	User1 User2	sRGB	Paper	Movie	DICOM
Brightness	√	√	√	√	-
Contrast	√	-	-	√	-
Temperature	√	-	√	√	-
Gamma	√	-	-	-	-
Super Resolution	√	-	√	√	-
Advanced Settings	Overdrive	√	-	-	-
	Hue	√	-	-	√
	Saturation	√	-	-	√
	Gain	√	-	-	-
Reset	√	√	√	√	-

Attention

- It takes about 30 minutes for the monitor display to stabilize. Please wait 30 minutes or more after power to the monitor has been turned on before adjusting the monitor.
- The same image may be observed in different colors on multiple monitors due to monitor-specific characteristics. Make fine color adjustments visually when matching colors across multiple monitors. Follow the procedure below to adjust and match colors across multiple monitors.
 1. Display a white screen on each monitor.
 2. Use one of the monitors as a visual reference point to make adjustments to the "Brightness", "Temperature", and "Gain" of the other monitors.
- When Auto EcoView is set to "On", the same brightness setting is shared by all of the color modes and cannot be set individually for each color mode.



Function	Setting Value	Description
Color Mode	User1 User2 sRGB Paper Movie DICOM	Select the desired mode according to the monitor application. The color mode settings can also be adjusted according to personal preference. Select the mode for adjustment and perform adjustment using the relevant functions. Note <ul style="list-style-type: none"> For details on the adjustment status of each mode, see “2-3. Switching Display Modes (Color Modes)” (page 14).
Brightness	0 to 100	The screen brightness is adjusted by changing the brightness of the backlight (light source from the LCD back panel). Note <ul style="list-style-type: none"> If the image is too dark even when the brightness is set to 100, adjust the contrast.
Contrast	0 to 100	The brightness of the screen is adjusted by varying the video signal level. Note <ul style="list-style-type: none"> A contrast of 50 displays every color gradation. When adjusting the monitor, it is recommended to perform brightness adjustment, which does not lose gradation characteristics, prior to contrast adjustment. Perform contrast adjustment in the following cases. <ul style="list-style-type: none"> If the image is too dark even when the brightness is set to 100 (Set the contrast to higher than 50.)
Temperature	Off 4000 K to 10000 K (in increments of 500 K. 9300 K is included.)	Adjust the color temperature. The color temperature is normally used to express the hue of “White” and/or “Black” with a numerical value. The value is expressed in degrees “K” (Kelvin). The screen becomes reddish at low color temperatures and bluish at high color temperatures, similar to the temperatures of a flame. A gain preset value is set for each color temperature setting value. Note <ul style="list-style-type: none"> The value shown in “K” is available only as a reference. “Gain” allows you to perform more advanced adjustment. If set to “Off”, the image is displayed in the preset color of the LCD panel (Gain: 100 for each RGB channel). When the gain is changed, the color temperature setting changes to “Off”.
Gamma	1.8 2.0 2.2 2.4	Adjust the gamma. While the brightness of the monitor varies depending on the video level of the input signal, the variation rate is not directly proportional to the input signal. Maintaining the balance between the input signal and brightness of the monitor is referred to as “Gamma correction”. Note <ul style="list-style-type: none"> If “sRGB” is selected for the color mode, “sRGB” is displayed for the gamma value. If “Paper” is selected for the color mode, “Paper” is displayed for the gamma value. If “DICOM” is selected for the color mode, “DICOM” is displayed for the gamma value.
Super Resolution	Off 1 2	Image blur can be reduced by enhancing its outline. Select “1” or “2” (outlines are more enhanced than “1”) according to personal preference.

Function		Setting Value	Description
Advanced Settings	Overdrive	Off On	<p>This function allows you to set the overdrive based on the use of the monitor. Image lag can be reduced by using the “On” setting when displaying moving images.</p> <p>Note</p> <ul style="list-style-type: none"> Depending on the display resolution and the setting of “Picture Expansion” (page 20), overdrive may be set to “Off”.
	Hue	-50 to 50	<p>Adjust the hue.</p> <p>Note</p> <ul style="list-style-type: none"> Using this function may prevent some color gradations from being able to be displayed.
	Saturation	-50 to 50	<p>Adjust the color saturation.</p> <p>Note</p> <ul style="list-style-type: none"> Using this function may prevent some color gradations from being able to be displayed. The minimum value (-50) changes the screen to monochrome.
	Gain	0 to 100	<p>The brightness of each red, green, and blue color component is referred to as “Gain”. The hue of “white” can be changed by adjusting the gain.</p> <p>Note</p> <ul style="list-style-type: none"> Using this function may prevent some color gradations from being able to be displayed. The gain value changes according to the color temperature. When the gain is changed, the color temperature setting changes to “Off”.
Reset	-	Reset any color adjustments for the currently selected color mode back to the default settings.	

● Signal Settings

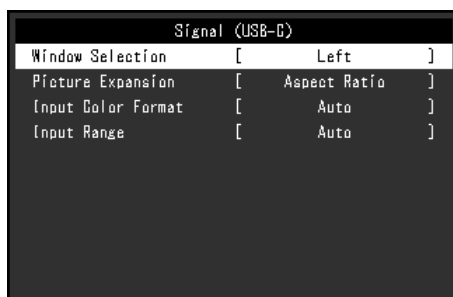
Set the details regarding input signal, such as the screen display size and color format.

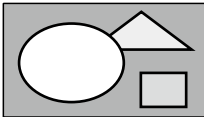
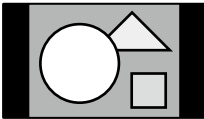

Function	Setting Value	Description
Window Selection	Left Right Center Upper Left Upper Right Lower Left Lower Right*1	Select the window to apply the “Signal Settings” to during PbyP display. For details on layouts for PbyP display, see “4-2. Using PbyP Display” (page 27). Note <ul style="list-style-type: none"> Enabled only during PbyP display. If an appropriate signal is not input, a setting value cannot be selected.
Picture Expansion	Auto *2 Full Screen Aspect Ratio Dot by Dot	The screen size of the monitor display can be changed. <ul style="list-style-type: none"> “Auto” The monitor automatically changes the screen size according to the aspect ratio and resolution information from the PC. “Full Screen” Images are stretched to full screen. Since aspect ratios are not maintained, images may be distorted in some cases. “Aspect Ratio” Images are enlarged to full screen without changing the aspect ratio. Since aspect ratios are maintained, blank horizontal or vertical borders may appear. “Dot by Dot” Displays the image at the set resolution or size specified by the input signal. Note <ul style="list-style-type: none"> Example settings <ul style="list-style-type: none"> - Full Screen  - Aspect Ratio  - Dot by Dot (input signal) 

*1 The selectable values depend on the layout

*2 Only enabled during HDMI input

Function	Setting Value	Description
Input Color Format	Auto YUV 4:2:2 *1 YUV 4:4:4 *1 YUV *2 RGB	The color format of the input signal can be specified. Try changing this setting if colors are not displayed correctly.
Input Range	Auto Full Limited	Depending on the video reproduction device, there may be a restriction on black and white video signal levels output to the monitor. This kind of signal is called "Limited range". On the other hand, unlimited signals are called "Full range". <ul style="list-style-type: none"> • "Auto" Input signal brightness range is automatically judged and is displayed appropriately (recommended setting). Depending on the video reproduction device, Limited range and Full range may not be able to be judged by the monitor. In such a case, selecting "Full" or "Limited" will allow it to be displayed appropriately. • "Full" To be selected in case of Full range signals. Appropriate display can be obtained when this is selected, in case both blacks and whites are corrupted. • "Limited" To be selected in case of Limited range signals. In case this is selected, the output signal range is expanded from 0 to 255 to obtain an appropriate display when black is pale and white is dull. <p>Note</p> <ul style="list-style-type: none"> • When "YUV" is selected in "Input Color Format", the setting is automatically set to "Limited". Additionally, when "Auto" is selected and the monitor determines the input color format to be YUV, the setting is automatically set to "Limited".

*1 Only enabled during HDMI input



*2 Only valid for DisplayPort or USB-C input

● Preference Settings

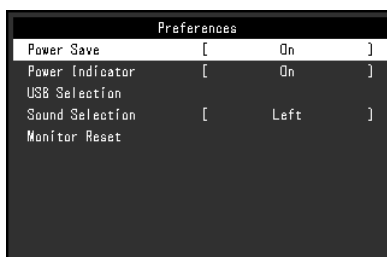
The monitor's settings can be configured to suit the usage environment or personal preference.

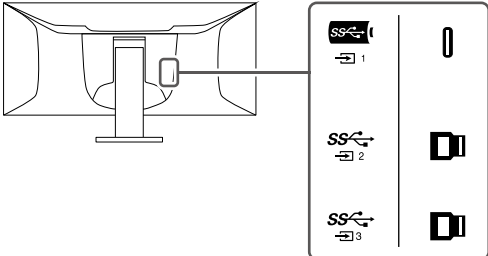
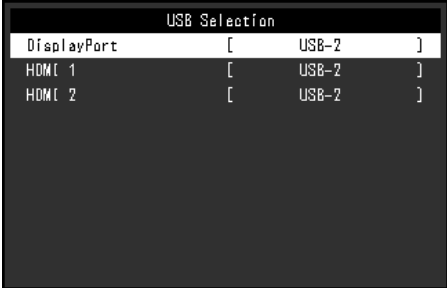

Function	Setting Value	Description
Power Save	On Off	<p>The monitor can be set to enter power saving mode according to the state of the PC.</p> <p>The monitor changes to power saving mode about 15 seconds after signal input ceases to be detected.</p> <p>When the monitor has shifted to power saving mode, images are not displayed on the screen and audio is not output.</p> <ul style="list-style-type: none"> • How to exit power saving mode <ul style="list-style-type: none"> - Press the operation switches (excluding ) on the front of the monitor - The monitor automatically exits power saving mode when the monitor receives input <p>Note</p> <ul style="list-style-type: none"> • At the time of shifting to power saving mode, a message that indicates the transition is displayed 5 seconds in advance. • For PbyP display, if there is no signal input for all connected PCs, the monitor shifts to power saving mode. • When not using the monitor, you can turn off the main power supply or disconnect the power plug so that the power is cut completely. • When “Compatibility Mode” (page 33) is set to “On”, even if the monitor shifts to power saving mode, devices connected to the USB downstream port are operational. Therefore, power consumption of the monitor varies with connected devices even in power saving mode.
Power Indicator	On Off	<p>The power indicator (white) can be turned off in normal operation mode.</p>

Function		Setting Value	Description
USB Selection	DisplayPort HDMI 1 HDMI 2	USB-1 (USB-C) USB-2 USB-3	<p>When two or three PCs are connected to one monitor, you can link the input signal with the USB upstream port. For details, see “4-3. Linking the Input Signal and USB Port” (page 30).</p> <p>The compatibility of setting values and USB connectors is as follows.</p> <p>USB-1 (USB-C) : USB-C connector (upstream) </p> <p>USB-2 : USB-B connector (upstream) </p> <p>USB-3 : USB-B connector (upstream) </p>  <p>Note</p> <ul style="list-style-type: none"> In the default settings, “USB-2” is set for all input signals. Change the settings so that they do not overlap.  <ul style="list-style-type: none"> When you want to change settings and there is a storage device such as USB memory connected to the monitor, change settings only after you have removed the storage device. In failing to do so, data may be lost or damaged. You cannot change the keyboard layout.
Sound Selection (PbyP)	Left Right Upper Right Lower Right Upper Left Lower Left Center*1		<p>Select the source of audio to output from the monitor during PbyP display. For details on layouts for PbyP display, see “4-2. Using PbyP Display” (page 27).</p> <p>Note</p> <ul style="list-style-type: none"> Enabled only during PbyP display.
Monitor Reset	-		<p>Restore all settings to their default values except for the following settings.</p> <ul style="list-style-type: none"> Settings on the “Administrator Settings” menu Settings for PbyP display “USB Selection” in the “Preferences” menu

*1 The selectable values depend on the layout

● EcoView Settings

This monitor is equipped with EcoView functions to enable users to conserve energy. If you use Auto EcoView, which is one of the EcoView functions, the screen brightness is automatically adjusted according to the ambient brightness.

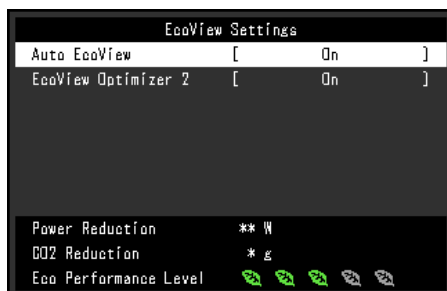

Function	Setting Value	Description
Auto EcoView	On Off	<p>The ambient light sensor on the front of the monitor detects the ambient brightness to automatically adjust the screen brightness to a comfortable level using Auto EcoView. The power consumption of the backlight can be curtailed by adjusting the brightness to an appropriate level.</p> <p>This function can also mitigate eye strain and tiredness caused by a screen that is too bright or too dark.</p> <p>Note</p> <ul style="list-style-type: none"> • Be careful not to block the ambient light sensor on the lower side of the monitor when using Auto EcoView. • Even if Auto EcoView is set to “On”, the “Brightness” can be changed in Color, according to your preferences. The manner in which Auto EcoView changes the brightness will also vary depending on the value you set. • When “DICOM” is selected for the color mode, the Auto EcoView setting is turned “Off”.
EcoView Optimizer 2	On Off	<p>The monitor automatically adjusts the screen brightness according to the white level of the input signal.</p> <p>This function can reduce power consumption while maintaining the brightness specified by the input signal.</p> <p>Note</p> <ul style="list-style-type: none"> • The setting is turned “Off” in the following cases: <ul style="list-style-type: none"> - When “Movie” or “DICOM” is selected for the color mode - When using PbyP display • When set to “On”, the appearance of pale colors may change. If this bothers you, set this function to “Off”.

Note

- The power saving level (Power Reduction, CO₂ Reduction, and Eco Performance Level) can be checked on the “EcoView Settings” menu. The more indicators that light up representing the Eco Performance Level, the higher the power saving level attained.
 - Power Reduction: the reduction in the backlight’s power consumption as a result of the adjusted brightness value.
 - CO₂ Reduction: converted from the “Power Reduction” value, this is an estimate of the quantity of CO₂ emissions reduced when using the monitor for 1 hour.
- The numeric value is a result of calculation based on a default setting (0.000555t-CO₂ / kWh) determined by a Japanese ministerial ordinance (2006, Ministry of Economy, Trade and Industry, Ministry of Environment, civil code article 3) and may differ depending on country and year.

● Language

The display language for menus and messages can be selected.

Setting Value

English, German, French, Spanish, Italian, Swedish, Japanese, Simplified Chinese, Traditional Chinese



Attention

- The display language of the "Administrator Settings" menu cannot be changed.

● Information

You can check the monitor information (model name, serial number (S/N), firmware version, usage time) and the input signal information.

Example: • Single window display

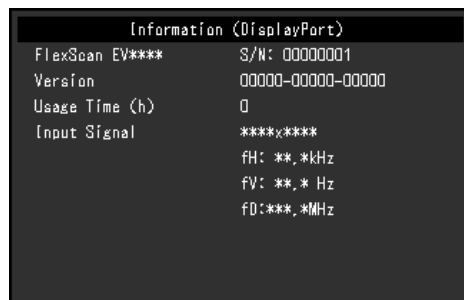

• PbyP display

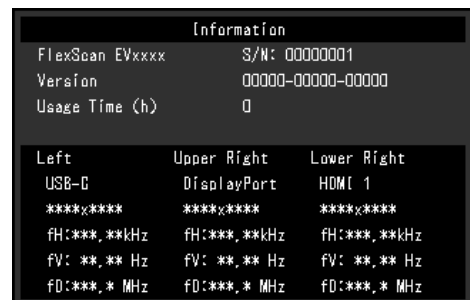

Chapter 4 Connecting Multiple PCs

4-1. Connecting Multiple PCs

This product can be connected to multiple PCs and allows you to switch between the connections for display.

● Connection examples

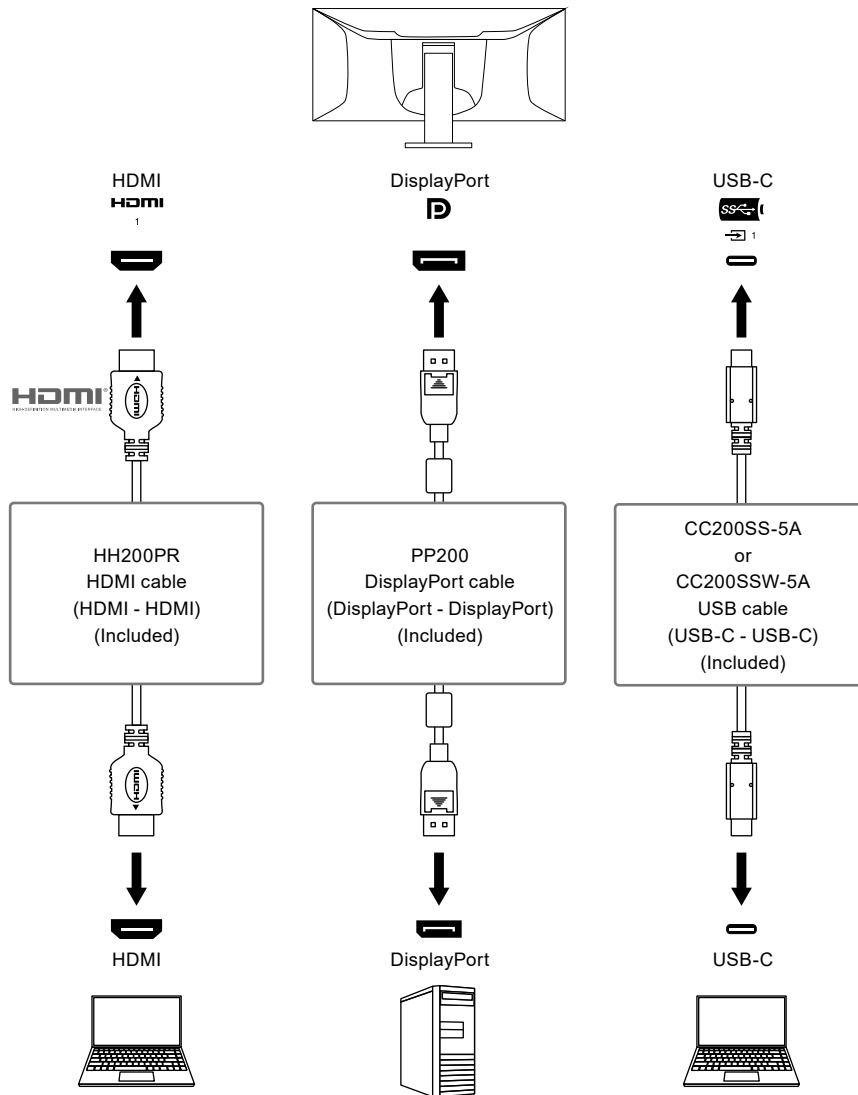

Note

- You can select the input signal to display using the operation switch () on the front of the monitor. For details, see “2-2. Switching Input Signals” (page 14).
- This product provides a function that automatically recognizes the connector through which PC signals are input, and displays images on the screen accordingly. For details, see “Auto Input Detection” (page 33).

4-2. Using PbyP Display

If you select PbyP display and input multiple signals to the monitor, you can display multiple windows side-by-side. Up to three windows can be displayed on one screen, so switching signals is no longer necessary and work productivity improves. The combination of signals can also be changed.

● PbyP Settings

Two window display (2 PbyP)

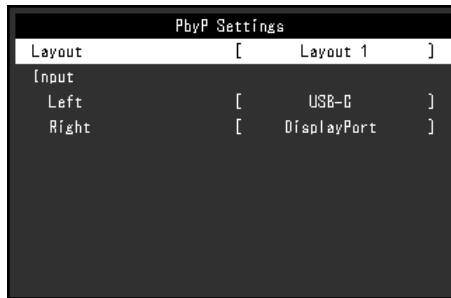

Layout 1

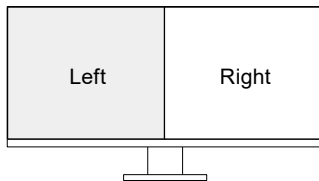

Layout 2

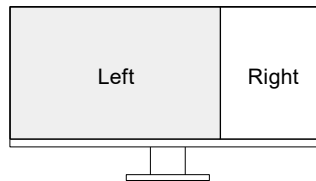

Layout 3

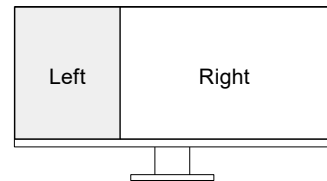

Function		Setting Value	Description
Layout		Layout 1 Layout 2 Layout 3	Select a layout.
Input	Left Right	USB-C DisplayPort HDMI 1 HDMI 2	Select an input signal for each window.

Three window display (3 PbyP)

PbyP Settings		
Layout	[Layout 1]
Main Window Swap	[Upper Right]
Input		
Left	[USB-C]
Upper Right	[DisplayPort]
Lower Right	[HDMI 1]

Layout 1

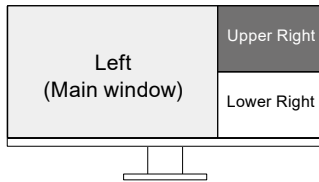

Layout 2

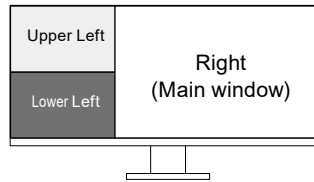

Layout 3

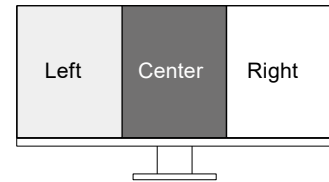

Function		Setting Value	Description
Layout		Layout 1 Layout 2 Layout 3	Select a layout.
Main Window Swap		Upper Left Upper Right Lower Left Lower Right*1	Select the window to use as the main window. For details, refer to “Swapping the Main Window of Three Window Display” (page 29) . Note • This cannot be set for Layout 3.
Input	Upper Left Upper Right Lower Left Lower Right Left Right Center*1	USB-C DisplayPort HDMI 1 HDMI 2	Select an input signal for each window.

*1 The item names displayed depend on the layout

● Swapping the Main Window of Three Window Display

When using three window PbyP display, select the operation switch () on the front of the monitor to swap the main window.

- When “Upper Right” is selected for “Main Window Swap”

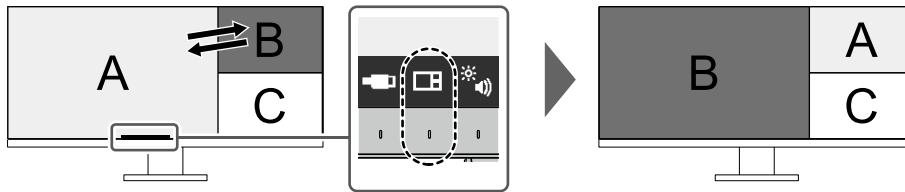

- When “Lower Right” is selected for “Main Window Swap”

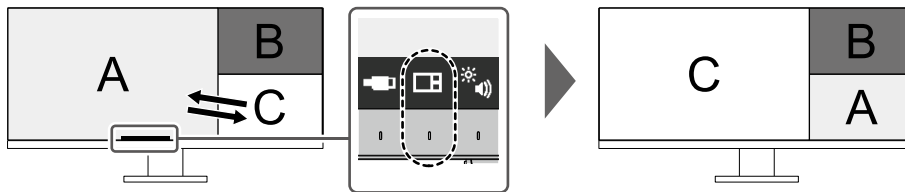

- When “Upper Left” is selected for “Main Window Swap”

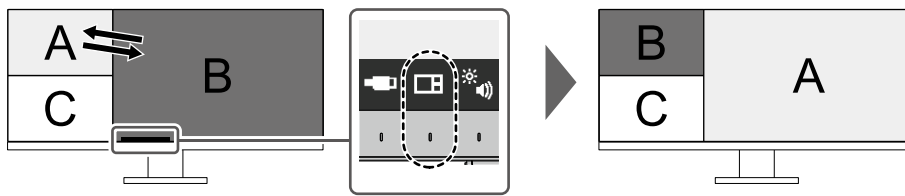

- When “Lower Left” is selected for “Main Window Swap”

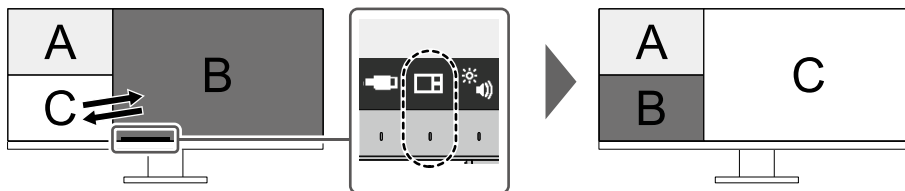

Note

- When USB-C connection and USB-B connection are used together, swapping the main window temporarily disconnects the USB signal. If there is a storage device such as USB memory connected to the monitor, swap the window only after you have removed the storage device. The wired LAN used via USB-C connection is also temporarily disconnected ([page 43](#)).
-

4-3. Linking the Input Signal and USB Port

When two or three PCs are connected to one monitor, you can link the input signal with the USB upstream port. This makes it possible to connect USB devices such as a mouse or keyboard to the monitor and use them from multiple PCs.

● Connection Example

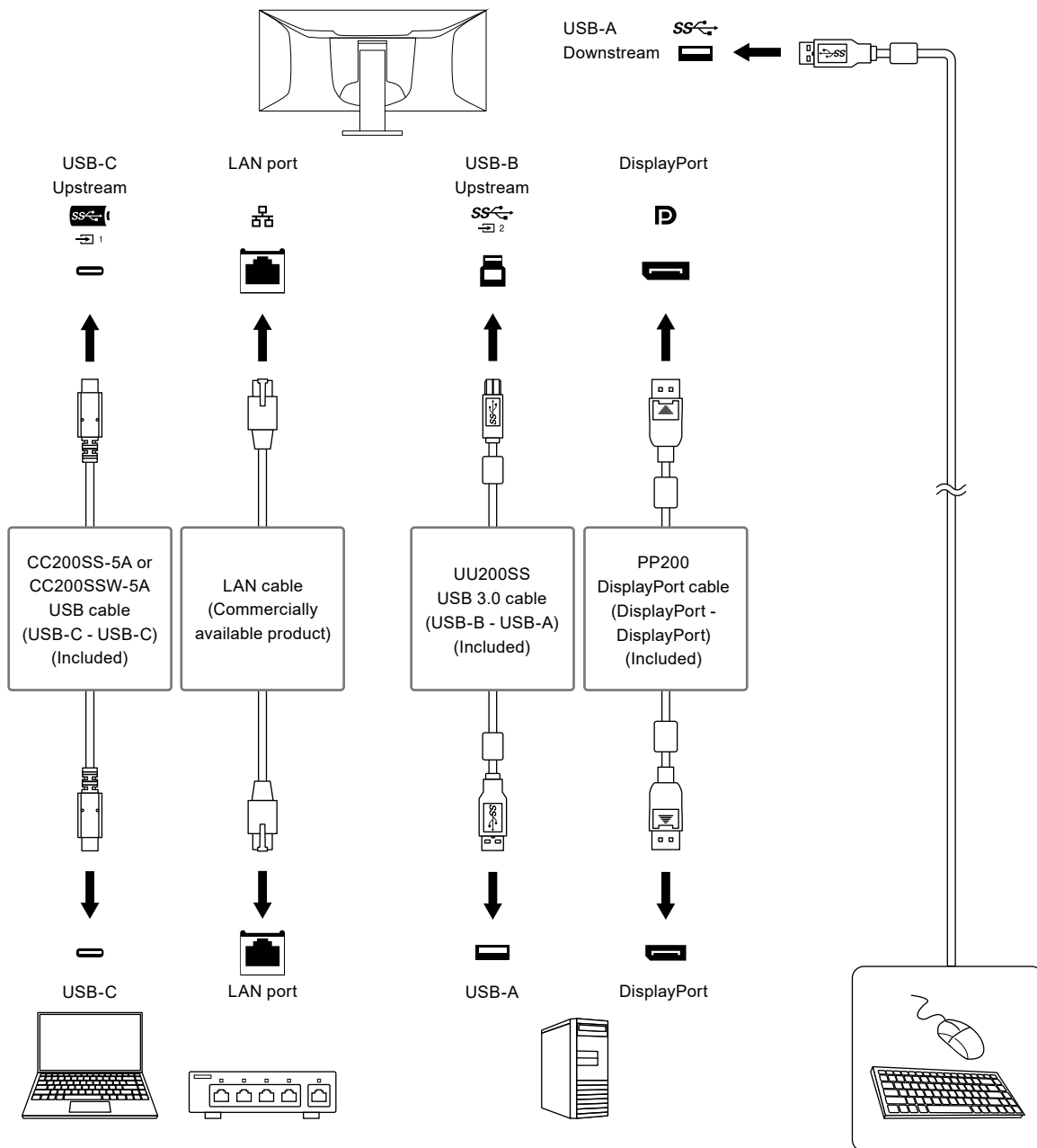

1. Linking

Refer to “[USB Selection](#)” (page 23) to link the USB upstream port to the input signal.

2. Switching USB Ports

Use either of the following methods to switch the USB upstream port.

- **Change the input signal.**

The USB upstream port switches automatically.

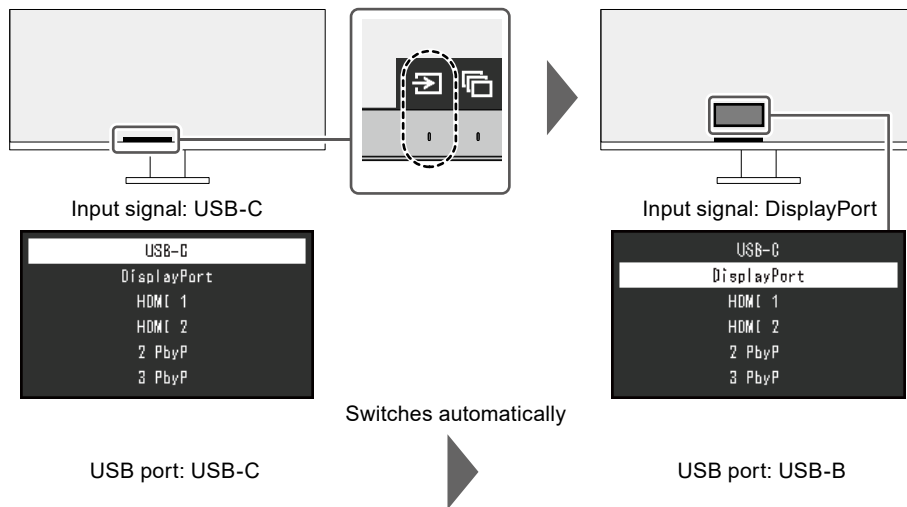

- **When multiple input signals are displayed with PbyP, use the operation switch (⏏) on the front of the monitor to switch USB upstream ports.**

1. When you touch the operation switch (⏏), a frame is displayed around one window. The USB port linked to the signal for this window is enabled.

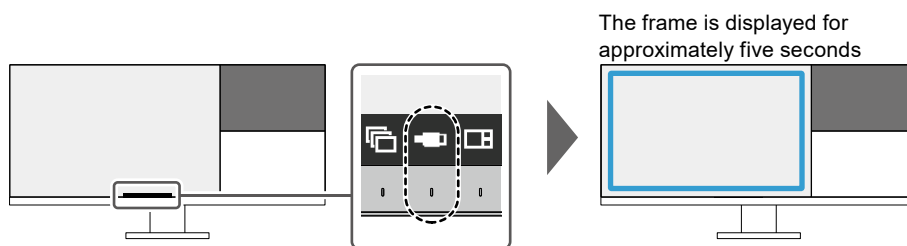

2. Each time you touch the operation switch (⏏), the frame moves clockwise.

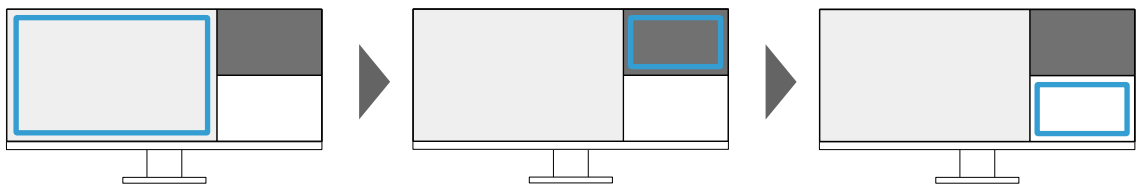

Note

- When only one USB port is connected, the connected port is enabled. The frame is also displayed on windows without USB connection, but the settings will not be applied.
- Even if main window swap is executed during three window PbyP display, the enabled USB port stays the main window.

Note



- When USB-C connection and USB-B connection are used together, switching the input signal or USB upstream port temporarily disconnects the USB signal. If there is a storage device such as USB memory connected to the monitor, switch the port only after you have removed the storage device. The wired LAN used via USB-C connection is also temporarily disconnected ([page 43](#)).

Chapter 5 Administrator Settings

This chapter describes how to configure monitor operation using the “Administrator Settings” menu.

5-1. Basic Operation of the “Administrator Settings” Menu

1. Menu display

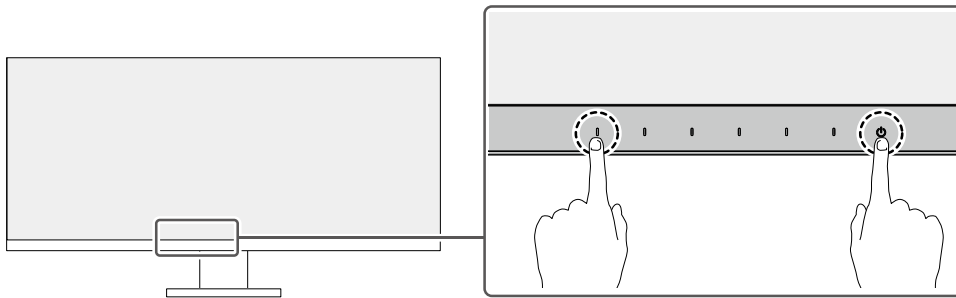

1. Touch  to turn off the monitor.
2. While touching the leftmost switch, touch  for more than 2 seconds to turn on the monitor.



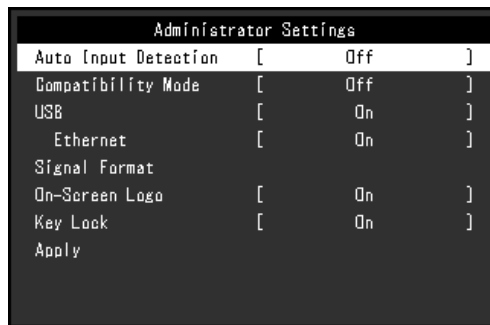



The “Administrator Settings” menu appears.

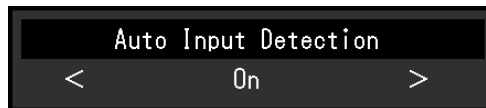

2. Setting

1. Select an item to set with   and select .
- The Adjustment / Setting menu appears.



2. Set with   and select .
- The “Administrator Settings” menu appears.

3. Applying and exiting

1. Select “Apply” and then .
- The settings are applied and the “Administrator Settings” menu exits.

Attention

- The language (English) of the “Administrator Settings” menu cannot be changed.

5-2. Functions of the “Administrator Settings” Menu

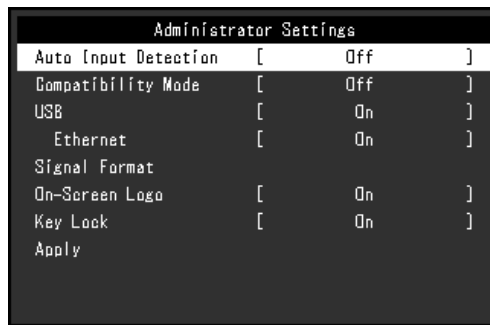

Function	Setting Value	Description
Auto Input Detection	On Off	<p>This function automatically recognizes the connector through which PC signals are input, and displays images on the screen accordingly.</p> <ul style="list-style-type: none"> • “On” When the monitor is connected to multiple PCs, if a specific PC enters power saving mode or no signals are input to the monitor, the connector is automatically changed to another one to which signals are input. • “Off” To be set to this when manually selecting input signals. In this case, you can select the input signal to display using the operation switch () on the front of the monitor. For details, see “2-2. Switching Input Signals” (page 14). <p>Note</p> <ul style="list-style-type: none"> • This does not function with PbyP display. • This product automatically recognizes the connector through which PC signals are input, and displays images on the screen accordingly regardless of whether this function is set to On or Off just after the main power switch on the rear side of the monitor has been turned on. • When this function is set to “On”, the monitor only enters the power saving mode when signals are not input from any PC.
Compatibility Mode	On Off	<p>If you want to avoid the following phenomena, set this function to “On”.</p> <ul style="list-style-type: none"> • The positions of windows and icons are shifted when the monitor is turned off / on or has returned from the power saving mode. • Even when the mouse or keyboard are used, the computer does not return from sleep. • When the power to the monitor is turned off, a device connected to the USB downstream port does not work, or power is not supplied to the connected device. • When the power to the monitor is turned off, power is not supplied to devices connected to the USB-C connector.

Function		Setting Value	Description
USB		On Off	<p>You can switch between enabling and disabling of the USB port of the monitor.</p> <ul style="list-style-type: none"> • "On" Enables the USB port. If you are using the following functions, set this function to "On". <ul style="list-style-type: none"> - Display of video signals using USB-C - Docking station function - USB Power Delivery - Screen InStyle (monitor control) • "Off" Disables the USB port so that USB peripheral devices cannot be used. <p>Note</p> <ul style="list-style-type: none"> • By pressing the switch on the far left for three seconds or more in the state where the power is turned on and the menu is not displayed, you can change the setting from "Off" to "On". The same operation cannot be used to change from "On" to "Off".
Ethernet		On Off	<p>You can switch between enabling and disabling of the LAN port of the monitor.</p> <ul style="list-style-type: none"> • "On" Enables the LAN port and allows network connections from PCs connected with USB-C. • "Off" Disables the LAN port. <p>Note</p> <ul style="list-style-type: none"> • When "USB" is set to "Off", this cannot be set.
Signal Format	USB-C	WQHD+ 60Hz / USB2.0 WQHD+ 30Hz / USB3.1	<p>You can switch the signal type that the monitor can display. Try changing this setting if the input signal is not displayed, or if the displayed image does not appear correctly.</p> <p>Note</p> <ul style="list-style-type: none"> • The "USB-C" settings switch between display signal priority "WQHD+ 60Hz / USB2.0" and USB speed priority "WQHD+ 30Hz / USB3.1". "WQHD+ 60Hz / USB2.0" is the default setting, with a maximum USB communication speed of 480 Mbps.
	DisplayPort	Version 1.1 Version 1.2	
	HDMI 1 HDMI 2	WQHD+ 60Hz WQHD+ 30Hz	
On-Screen Logo		On Off	<p>When the monitor is turned on, the EIZO logo appears on the screen.</p> <p>When this function is set to "Off", the EIZO logo does not appear.</p>
Key Lock		Off Menu All	<p>In order to prevent changes to settings, the operation switches on the front of the monitor can be locked.</p> <ul style="list-style-type: none"> • "Off" (default setting) Enables all switches. • "Menu" Locks the  switch. • "All" Locks all switches except the power switch.

Chapter 6 Troubleshooting

6-1. No Picture

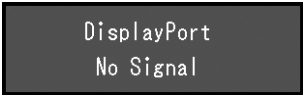
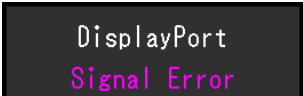
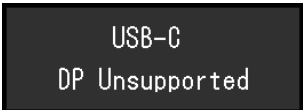
Problem	Possible cause and remedy
<p>1. No picture</p> <ul style="list-style-type: none"> Power indicator does not light up. Power indicator is lighting white. Power indicator is lighting orange. Power indicator is flashing orange and white. 	<ul style="list-style-type: none"> Check whether the power cord is connected properly. Turn on the main power switch on the rear side of the monitor. Touch . Turn off the main power switch on the rear side of the monitor, and then turn it on again a few minutes later. Increase “Brightness”, “Contrast”, or “Gain” in the Setting menu (see “Color Adjustment” (page 17)). Switch the input signal. Turn the setting “On” for “Compatibility Mode” on the “Administrator Settings” menu (see “Compatibility Mode” (page 33)). Move the mouse or press any key on the keyboard. Check whether the PC is turned on. Turn off the main power switch on the rear side of the monitor, and then turn it on again. This symptom may occur when the PC is connected to the DisplayPort connector. Use a signal cable recommended by us for the connection. Turn the monitor off and on. Check the connection and condition of the USB devices connected to the monitor.
<p>2. The message below appears.</p> <ul style="list-style-type: none"> This message appears when no signal is input. Example:  The message shows that the input signal is out of the specified frequency range. Example:  This message appears when the PC connected to the USB-C connector does not support video signal output. Example:  	<p>This message appears when the signal is not input correctly even though the monitor is functioning properly.</p> <ul style="list-style-type: none"> The message shown left may appear, because some PCs do not output the signal immediately after power-on. Check whether the PC is turned on. Check whether the signal cable is connected properly. Switch the input signal. Turn off the main power switch on the rear side of the monitor, and then turn it on again. Try changing “Signal Format” in the “Administrator Settings” menu (see “Signal Format” (page 34)). Try setting “Auto Input Detection” in the “Administrator Settings” menu to “Off” and switching the input signal manually (see “Auto Input Detection” (page 33)). Check whether the PC is configured to meet the resolution and vertical scan frequency requirements of the monitor (see “1-3. Supported Resolutions” (page 10)). Reboot the PC. Select an appropriate setting using the graphics board’s utility. See the User’s Manual of the graphics board for details. Check whether the connected cable is a signal cable recommended by us. Check whether the USB-C of the connected device supports video signal output (DisplayPort Alt Mode). For details, contact the manufacturer of the device. Connect a DisplayPort cable or an HDMI cable.

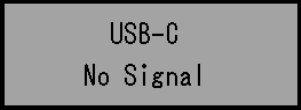
Problem	Possible cause and remedy
<ul style="list-style-type: none">This message appears when the USB port of the monitor is disabled. Example: 	<ul style="list-style-type: none">Check whether "USB" in the "Administrator Settings" menu is set to "On" (see "USB" (page 34)).

6-2. Imaging Problems

Problem	Possible cause and remedy
1. The screen is too bright or too dark.	<ul style="list-style-type: none"> • Use “Brightness” or “Contrast” in the Setting menu to adjust it (see “Color Adjustment” (page 17)). (The LCD monitor backlight has a limited life span. If the screen becomes dark or begins to flicker, contact your local EIZO representative.) • If the screen is too bright, try changing the Auto EcoView setting to “On”. The monitor detects the ambient brightness to adjust the screen brightness automatically (see “Auto EcoView” (page 24)).
2. The brightness changes on its own.	<ul style="list-style-type: none"> • Try changing the Auto EcoView setting to “Off” (see “Auto EcoView” (page 24)).
3. Text is blurred.	<ul style="list-style-type: none"> • Check whether the PC is configured to meet the resolution and vertical scan frequency requirements of the monitor (see “1-3. Supported Resolutions” (page 10)). For the method for changing PC settings, refer to our website (www.eizoglobal.com). • Try setting the magnification of display on the OS to “100%”. When using multiple monitors, try setting the magnification of display to “100%” on all monitors.
4. Afterimages appear.	<ul style="list-style-type: none"> • Afterimages are particular to LCD monitors. Avoid displaying the same image for a long time. • Use the screen saver or power saving function to avoid displaying the same image for extended periods of time. Depending on the image, an afterimage may appear even if it was displayed for a short period of time. To remove such a phenomenon, change the image or keep the power turned off for several hours.
5. Green / red / blue / white / dark dots remain on the screen.	<ul style="list-style-type: none"> • This is due to LCD panel characteristics and not a malfunction.
6. Interference patterns or pressure marks remain on the LCD panel.	<ul style="list-style-type: none"> • Leave the monitor with a white or black screen. The symptom may disappear.
7. Noise appears on the screen.	<ul style="list-style-type: none"> • In the Setting menu, set “Overdrive” to “Off” (see “Overdrive” (page 19)). • When inputting HDCP system signals, normal images may not be displayed immediately. • When inputting an HDMI signal, try changing “Signal Format” in the “Administrator Settings” menu (see “Signal Format” (page 34)).
8. The positions of windows and icons are shifted when the monitor is turned off / on or when restored from power saving mode.	<ul style="list-style-type: none"> • Turn the setting “On” for “Compatibility Mode” on the “Administrator Settings” menu (see “Compatibility Mode” (page 33)).
9. The color shown on the screen is not correct.	<ul style="list-style-type: none"> • Try changing “Input Color Format” in the Setting menu (see “Input Color Format” (page 21)).
10. Images are not displayed over the entire area of the screen.	<ul style="list-style-type: none"> • Try changing “Picture Expansion” in the Setting menu (see “Picture Expansion” (page 20)). • Try changing “Signal Format” in the “Administrator Settings” menu (see “Signal Format” (page 34)). • Check whether the setting for the resolution of the PC matches the resolution of the monitor.

6-3. Other Problems

Problem	Possible cause and remedy
1. The Setting menu does not appear.	<ul style="list-style-type: none"> • Check whether the switch operation lock function is active (see “Key Lock” (page 34)).
2. Cannot select items in the Setting menu.	<ul style="list-style-type: none"> • Items that are displayed with gray text cannot be changed.
3. No audio output.	<ul style="list-style-type: none"> • Check whether volume is set to 0. • Check the PC and audio playback software to see whether they are configured correctly. • When using PbyP display, check the settings for “Sound Selection (PbyP)” (see “Sound Selection (PbyP)” (page 23)).
4. USB devices connected to the monitor do not work / the docking station function cannot be used.	<ul style="list-style-type: none"> • Check whether the USB cable is correctly connected between the PC and the monitor. • When two or three PCs are connected to one monitor, check whether the correct USB upstream port is enabled (see “4-3. Linking the Input Signal and USB Port” (page 30)). • Check whether the USB cable is correctly connected between the peripheral and the monitor. • Try using a different USB port on the monitor. • Try using a different USB port on the PC. • Reboot the PC. • When “Compatibility Mode” is set to “Off” in the “Administrator Settings” menu and the power of the monitor is turned off, devices connected to the USB downstream port are not operational. Change the setting for “Compatibility Mode” to “On” (see “Compatibility Mode” (page 33)). • When “USB” is set to “Off” in the “Administrator Settings” menu, peripheral devices connected to the USB port cannot be used. Set “USB” to “On” (see “USB” (page 34)). • In the following cases, the LAN port cannot be used. <ul style="list-style-type: none"> - When “Ethernet” is set to “Off” in the “Administrator Settings” menu. Set “Ethernet” to “On” (see “Ethernet” (page 34)). - When USB-C connection is not used. - When the OS of the PC is not supported (see “8-2. Specifications” (page 45)). • If the peripheral devices work correctly when they are directly connected to the PC, contact your local EIZO representative. • Depending on the USB host controller you are using, the connected USB device may not be recognized properly. Update to the latest USB driver provided by the manufacturer, or connect the monitor to the USB 2.0 port. • Check the PC’s BIOS setting for USB when using Windows. (See the manual of the PC for details.)
5. Power indicator is flashing orange and white.	<ul style="list-style-type: none"> • This symptom may occur when the PC is connected to the DisplayPort connector. Use a signal cable recommended by us for the connection. Turn the monitor off and on. • Check the connection and condition of the USB devices connected to the monitor. • Turn off the main power switch on the rear side of the monitor, and then turn it on again.
6. Even when the mouse or keyboard are used, the computer does not return from sleep.	<ul style="list-style-type: none"> • Turn the setting “On” for “Compatibility Mode” on the “Administrator Settings” menu (see “Compatibility Mode” (page 33)).

Problem	Possible cause and remedy
7. The PC does not work when power is supplied from the monitor (USB Power Delivery)	<ul style="list-style-type: none">• Check whether the PC has the specifications to operate with 85 W of power supply.• Use the following USB cables for 85 W power supply.<ul style="list-style-type: none">- CC200SS-5A or CC200SSW-5A (Included)- CC100 (Separately sold accessory)

Chapter 7 Attaching/Removing the Stand

7-1. Removing the Stand

The stand section of this product can be removed.

Attention

- Do not move the stand up and down after removing it. If you move the stand up and down while it is not attached to the monitor, this may cause damage or injury.
- If you drop the monitor or stand, this may cause damage or injury due to the weight of the monitor and stand.

1. Remove the connector cover.

2. Raise the height of the monitor to the maximum height.

Attention

- If the monitor is not raised to the maximum height, there may be cases when the height of the monitor accidentally changes while removing the stand. This may be the cause of injury or damage.

3. Lay the LCD monitor on a cushion or a soft cloth spread over a stable and flat surface with the LCD panel surface facing down.

Attention

- The LCD panel is curved and may be damaged if placed on a hard surface.

4. Remove the stand.

As shown in the diagram, press the lock button (1) while holding firmly onto the support section of the stand, and slide the stand in the direction of the pedestal on the bottom (2). Next, pull the stand upwards to remove it (3).

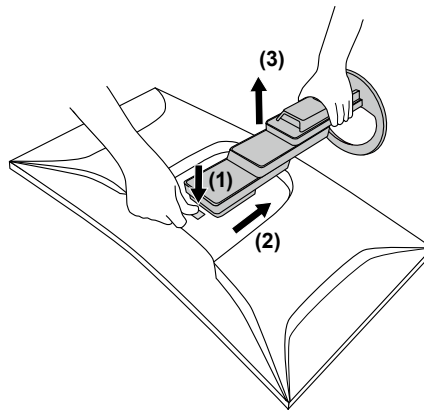

7-2. Attaching the Optional Arm

By removing the stand from the monitor, it is possible to attach the monitor to a different arm or stand.

Attention

- When attaching an arm or stand, follow the instructions of the respective User's Manual.
- When using another manufacturer's arm or stand, confirm the following in advance and select one conforming to the VESA standard. Use the VESA mounting screws supplied with this product when attaching the arm or stand.
 - Clearance between screw holes: 100 mm × 100 mm
 - VESA mount of the arm or stand, external dimensions: 122 mm x 122 mm or less (sizes larger than this cannot be attached without interfering with the product).
 - Plate thickness: 2.6 mm
 - Strong enough to support weight of the monitor unit (excluding the stand) and attachments such as cables.
- When attaching an arm or stand, the installable orientations and movement range (tilt angle) are as follows:

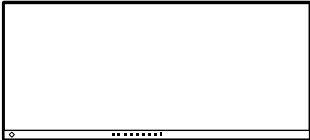
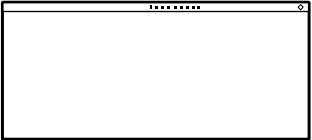
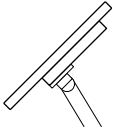
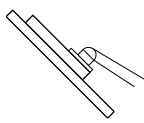
Orientation		
Movement range (tilt angle)	 <p>Up: 45°</p>	 <p>Down: 45°</p>

- Connect the cables after attaching an arm or stand.
- Do not move the removed stand up and down. Doing so may result in injury or device damage.
- The monitor, arm, and stand are heavy. Dropping them may result in injury or equipment damage.
- Check periodically that the screws are tight enough. If the screws are not tight enough, the monitor may come unattached. This may be the cause of injury or damage.

1. Attach the arm or stand to the monitor.

Use the VESA mounting screws supplied with this product when attaching the arm or stand.

7-3. Attaching the original stand

1. Lay the LCD monitor on a cushion or a soft cloth spread over a stable and flat surface with the LCD panel surface facing down.

Attention

- The LCD panel is curved and may be damaged if placed on a hard surface.
-

2. Remove the fixing screws on the optional arm (or optional stand), and detach the optional arm (or optional stand).

3. Attach the original stand.

Insert the four tabs on the stand into the four holes on the back panel (1), and slide the stand towards the upper portion of the monitor (2). The stand clicks when it is attached correctly.

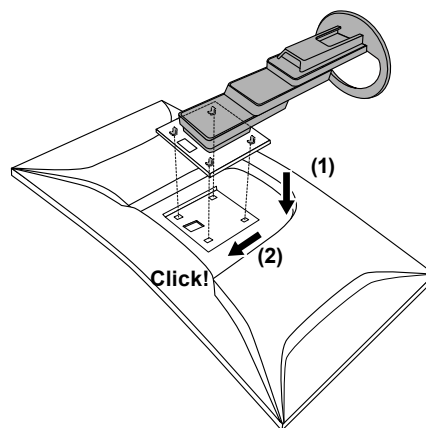

Chapter 8 Reference

8-1. Using the Docking Station Function

This product is equipped with a LAN port and USB hub so that it can be used as a docking station. By connecting a USB-C cable, you can create a stable network environment even on notebook PCs or tablet devices that are not equipped with LAN ports. You can also use USB-compatible peripheral devices and charge smartphones.

● Connection Procedure

1. Connect the USB-C cable (CC200SS-5A or CC200SSW-5A).
2. Connect a LAN cable to the LAN port of the monitor.
3. If necessary, connect a mouse, keyboard, or other device to the USB downstream port.

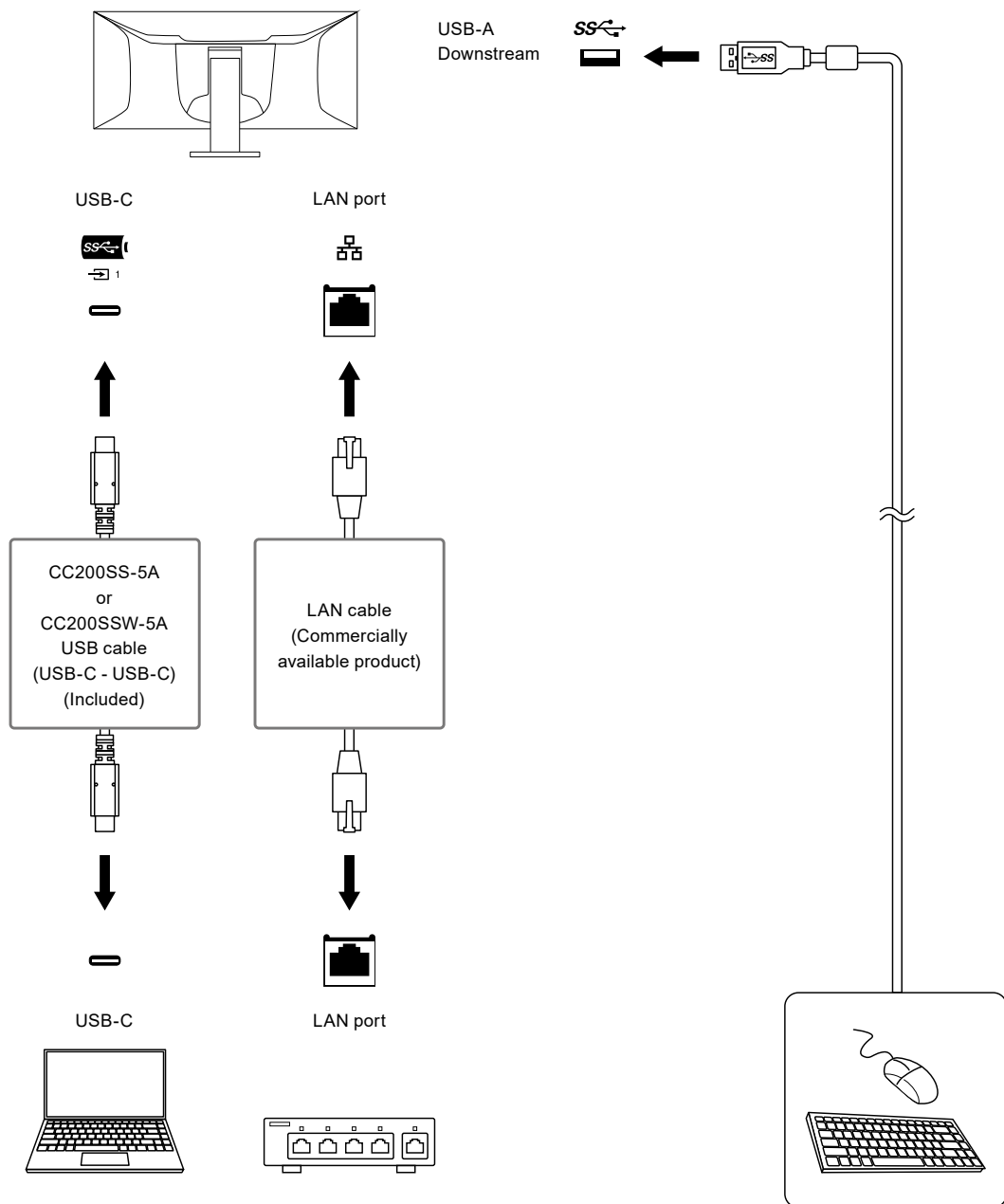

Attention

- When the OS of the PC you are using is Windows 8.1, it is necessary to install the driver to use the LAN port. The driver is stored in the monitor. If you connect the PC and the monitor with a USB cable, the installation screen appears. Install the driver following the instructions on the screen.
- This function may not work depending on the computer you are using, your OS and your peripheral devices. Contact the manufacturer of each device for information about USB compatibility.
- Even when the monitor is in power saving mode, devices connected to the USB downstream port are operational. Due to this, the power consumption of the monitor varies depending on the connected devices, even in power saving mode.
- When the main power of the monitor is off, a device connected to the USB downstream port will not operate.
- When “[Compatibility Mode](#)” ([page 33](#)) is set to “Off” and the power of the monitor is turned off, devices connected to the USB downstream port and the LAN port are not operational.

Note

- The MAC address is recorded on the label on the rear of the monitor. MAC address pass-through is not supported.
 - This product supports USB 3.1 Gen 1. When connecting to peripheral devices that support USB 3.1 Gen 1, high-speed data communication is possible.
For USB-C connection, you can switch between display signal priority “WQHD+ 60Hz / USB2.0” and USB speed priority “WQHD+ 30Hz / USB3.1” (see “[Signal Format](#)” ([page 34](#))). “WQHD+ 60Hz / USB2.0” is the default setting, with a maximum USB communication speed of 480 Mbps.
 - For USB-B connection, the LAN port cannot be used.
-

8-2. Specifications

LCD Panel	Type	IPS (Anti-Glare)	
	Backlight	LED	
	Size	95.3 cm (37.5 inch)	
	Resolution	3840 dots × 1600 lines	
	Display Size (H × V)	879.7 mm × 366.5 mm	
	Pixel Pitch	0.229 mm × 0.229 mm	
	Display Colors	8-bit colors:	16.77 million colors
	Viewing Angle (H / V, typical)	178° / 178°	
	Response Time (typical)	Gray-to-gray:	6 ms (overdrive setting: Off) 5 ms (overdrive setting: On)
Video Signals	Input Terminals	DisplayPort (HDCP 1.3 compatible) × 1, HDMI (HDCP 2.2 / 1.4 compatible) ^{*1} × 2, USB-C (DisplayPort Alt Mode, HDCP 1.3 compatible) × 1	
	Digital Scanning Frequency (H / V)	DisplayPort:	31 kHz to 99 kHz / 29 Hz to 61 Hz, 69 Hz to 71 Hz (at 720 × 400)
		HDMI:	31 kHz to 99 kHz / 29 Hz to 61 Hz, 69 Hz to 71 Hz (at 720 × 400)
		USB-C (DisplayPort Alt Mode):	31 kHz to 99 kHz / 29 Hz to 61 Hz, 69 Hz to 71 Hz (at 720 × 400)
	Frame Synchronization Mode	49.5 Hz to 61 Hz	
	Max. Dot Clock	395.0 MHz	
USB	Port	Upstream	USB-C (USB 3.1 Gen 1) ^{*2*3} × 1 USB-B (USB 3.1 Gen 1) × 2
		Downstream	USB-A (USB 3.1 Gen 1) × 4
	Standard	USB Specification Revision 3.1 Gen 1	
	Communication Speed ^{*4}	5 Gbps (super), 480 Mbps (high), 12 Mbps (full), 1.5 Mbps (low)	
	Power Supply	Upstream	USB-C (USB 3.1 Gen 1): Maximum 85 W (5V/3A, 9V/3A, 12V/3A, 15V/3A, 20V/4.25A)
		Downstream	USB-A (USB 3.1 Gen 1): Maximum 900 mA per port ^{*5}
Audio	Audio Input Format	DisplayPort:	2ch linear PCM (32 kHz / 44.1 kHz / 48 kHz / 88.2 kHz / 96 kHz / 176.4 kHz / 192 kHz)
		HDMI:	2ch linear PCM (32 kHz / 44.1 kHz / 48 kHz / 88.2 kHz / 96 kHz / 176.4 kHz / 192 kHz)
		USB-C (DisplayPort Alt Mode):	2ch linear PCM (32 kHz / 44.1 kHz / 48 kHz / 88.2 kHz / 96 kHz / 176.4 kHz / 192 kHz)
	Speakers	1 W + 1 W	
	Headphones	2 mW + 2 mW (32 Ω)	
	Input Terminals	DisplayPort × 1, HDMI × 2, USB-C (DisplayPort Alt Mode) × 1 (each shared with video signal)	
	Output Terminals	Headphone jack × 1	

Network	Port	RJ-45 (USB LAN Adapter)
	Supported OS* ⁶	Microsoft Windows 11 Microsoft Windows 10 (32-bit/64-bit) Microsoft Windows 8.1 (32-bit/64-bit) macOS Sierra (10.12) or later
	Wired LAN	IEEE802.3ab (1000BASE-T), IEEE802.3u (100BASE-TX), IEEE802.3 (10BASE-T)
Power	Input	100 - 240 VAC ±10 %, 50 / 60 Hz 1.95 A - 0.85 A
	Maximum Power Consumption	194 W or less
	Power Save Mode	0.5 W or less (no USB device connected, "USB" in the "Administrator Settings" menu: Off)
	Standby Mode	0.5 W or less (no USB device connected, default settings)
Physical Specifications	Dimensions	893.9 mm × 418.2 mm to 633.2 mm × 281.4 mm to 307.6 mm (W × H × D) (Tilt: 35°)
		893.9 mm × 411.0 mm to 603.7 mm × 240.0 mm (W × H × D) (Tilt: 0°)
	Dimensions (Without Stand)	893.9 mm × 398.2 mm × 109.8 mm (W × H × D)
	Net Weight	Approx. 13.2 kg
	Net Weight (Without Stand)	Approx. 9.5 kg
	Height Adjustment Range	215.0 mm (Tilt: 35°) / 192.7 mm (Tilt: 0°)
	Tilt	Up 35.0°, Down 5.0°
Swivel	70.0°	
Operating Environmental Requirements	Temperature	5 °C to 35 °C
	Humidity	20 % to 80 % R.H. (no condensation)
	Air Pressure	540 hPa to 1060 hPa
Transportation / Storage Environmental Requirements	Temperature	-20 °C to 60 °C
	Humidity	10 % to 90 % R.H. (no condensation)
	Air Pressure	200 hPa to 1060 hPa

*1 HDMI CEC (or mutual control) is not supported.

*2 You can switch between display signal priority "WQHD+ 60Hz / USB2.0" and USB speed priority "WQHD+ 30Hz / USB3.1" (see "Signal Format" (page 34)). "WQHD+ 60Hz / USB2.0" is the default setting, with a maximum USB communication speed of 480 Mbps.

*3 Supports Pin Assignment E. The separately sold accessory CP200 (USB-C - DisplayPort) can be connected to the DisplayPort connector of the PC.

*4 For USB-C connection, if you select display signal priority "WQHD+ 60Hz / USB2.0", the maximum communication speed is 480 Mbps (see "Signal Format" (page 34)).

*5 It is possible to supply power even if the PC and the monitor are not connected by USB.

*6 EIZO support will end when OS vendor support ends.

● Accessories

For the latest information about accessories, refer to our web site www.eizoglobal.com.

Appendix

Trademark

The terms HDMI and HDMI High-Definition Multimedia Interface, and the HDMI Logo are trademarks or registered trademarks of HDMI Licensing, LLC in the United States and other countries.

The DisplayPort Compliance Logo and VESA are registered trademarks of the Video Electronics Standards Association.

The SuperSpeed USB Trident Logo is a registered trademark of USB Implementers Forum, Inc.



The USB Power Delivery Trident Logos are trademarks of USB Implementers Forum, Inc.



USB Type-C is a registered trademark of USB Implementers Forum, Inc.

DICOM is the registered trademark of the National Electrical Manufacturers Association for its standards publications relating to digital communications of medical information.

Kensington and Microsaver are registered trademarks of ACCO Brands Corporation.

Thunderbolt is a trademark of Intel Corporation in the United States and/or other countries.

Microsoft and Windows are registered trademarks of Microsoft Corporation in the United States and other countries.

Adobe is a registered trademark of Adobe Systems Incorporated in the United States and other countries.

Apple, macOS, Mac OS, OS X, Macintosh and ColorSync are registered trademarks of Apple Inc.

ENERGY STAR is a registered trademark of the United States Environmental Protection Agency in the United States and other countries.

Ethernet is a registered trademark of Fuji Xerox Co., Ltd.

EIZO, the EIZO Logo, ColorEdge, CuratOR, DuraVision, FlexScan, FORIS, RadiCS, RadiForce, RadiNET, Raptor and ScreenManager are registered trademarks of EIZO Corporation in Japan and other countries.

ColorEdge Tablet Controller, ColorNavigator, EcoView NET, EIZO EasyPIX, EIZO Monitor Configurator, EIZO ScreenSlicer, G-Ignition, i•Sound, Quick Color Match, RadiLight, Re/Vue, SafeGuard, Screen Administrator, Screen InStyle, ScreenCleaner and UniColor Pro are trademarks of EIZO Corporation.

All other company names, product names, and logos are trademarks or registered trademarks of their respective owners.

License

The bitmap font used for this product is designed by Ricoh Industrial Solutions Inc.

