

# AOC

## LCD Monitor User Manual

**AG493UCX** LED backlight

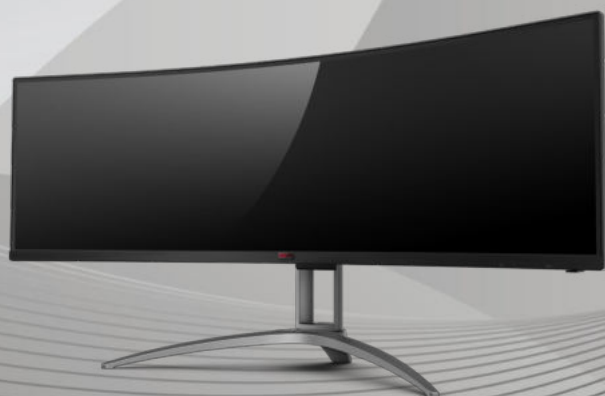

**HDMI**<sup>®</sup>

[www.aoc.com](http://www.aoc.com)

©2019 AOC. All Rights Reserved.

Safety .....	1
National Conventions .....	1
Power .....	2
Installation .....	3
Cleaning .....	4
Other .....	5
Setup .....	6
Contents in Box .....	6
Setup Stand & Base .....	7
Adjusting the monitor .....	8
Connecting the Monitor .....	9
Adaptive-Sync function .....	10
HDR .....	11
Adjusting .....	12
Hotkeys .....	12
Description of the remote control buttons .....	13
OSD Key Guide (Menu) .....	14
OSD Setting .....	16
Game Setting .....	17
Luminance .....	19
Image Setup .....	20
Color Setup .....	21
Extra .....	22
OSD Setup .....	23
LED Indicator .....	24
Troubleshoot .....	25
Specification .....	26
General Specification .....	26
Preset Display Modes .....	27
Pin Assignments .....	28
Plug and Play .....	29

# Safety

## National Conventions

The following subsections describe notational conventions used in this document.

### Notes, Cautions, and Warnings

Throughout this guide, blocks of text may be accompanied by an icon and printed in bold type or in italic type. These blocks are notes, cautions, and warnings, and they are used as follows:



**NOTE:** A NOTE indicates important information that helps you make better use of your computer system.





**CAUTION:** A CAUTION indicates either potential damage to hardware or loss of data and tells you how to avoid the problem.





**WARNING:** A WARNING indicates the potential for bodily harm and tells you how to avoid the problem. Some warnings may appear in alternate formats and may be unaccompanied by an icon. In such cases, the specific presentation of the warning is mandated by regulatory authority.

## Power

 The monitor should be operated only from the type of power source indicated on the label. If you are not sure of the type of power supplied to your home, consult your dealer or local power company.

 The monitor is equipped with a three-pronged grounded plug, a plug with a third (grounding) pin. This plug will fit only into a grounded power outlet as a safety feature. If your outlet does not accommodate the three-wire plug, have an electrician install the correct outlet, or use an adapter to ground the appliance safely. Do not defeat the safety purpose of the grounded plug.

 Unplug the unit during a lightning storm or when it will not be used for long periods of time. This will protect the monitor from damage due to power surges.

 Do not overload power strips and extension cords. Overloading can result in fire or electric shock.

 To ensure satisfactory operation, use the monitor only with UL listed computers which have appropriate configured receptacles marked between 100-240V AC, Min. 5A.

 The wall socket shall be installed near the equipment and shall be easily accessible.

# Installation

**!** Do not place the monitor on an unstable cart, stand, tripod, bracket, or table. If the monitor falls, it can injure a person and cause serious damage to this product. Use only a cart, stand, tripod, bracket, or table recommended by the manufacturer or sold with this product. Follow the manufacturer's instructions when installing the product and use mounting accessories recommended by the manufacturer. A product and cart combination should be moved with care.

**!** Never push any object into the slot on the monitor cabinet. It could damage circuit parts causing a fire or electric shock. Never spill liquids on the monitor.

**!** Do not place the front of the product on the floor.

**!** If you mount the monitor on a wall or shelf, use a mounting kit approved by the manufacturer and follow the kit instructions.

**!** Leave some space around the monitor as shown below. Otherwise, air-circulation may be inadequate hence overheating may cause a fire or damage to the monitor.

See below the recommended ventilation areas around the monitor when the monitor is installed on the wall or on the stand:

## Installed with stand

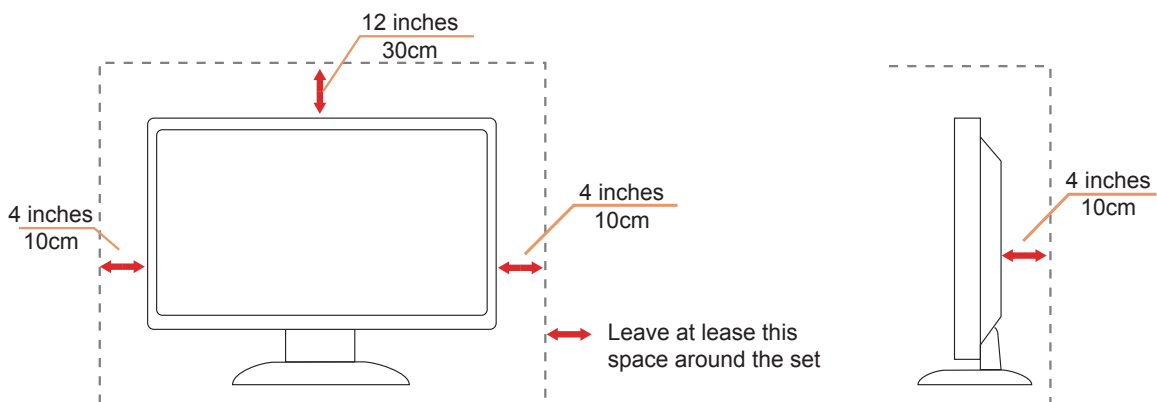

## Cleaning

⚠ Clean the cabinet regularly with cloth. You can use soft-detergent to wipe out the stain, instead of strong-detergent which will cauterize the product cabinet.

⚠ When cleaning, make sure no detergent is leaked into the product. The cleaning cloth should not be too rough as it will scratch the screen surface.

⚠ Please disconnect the power cord before cleaning the product.



## Other

 If the product is emitting a strange smell, sound or smoke, disconnect the power plug IMMEDIATELY and contact a Service Center.

 Make sure that the ventilating openings are not blocked by a table or curtain.

 Do not engage the LCD monitor in severe vibration or high impact conditions during operation.

 Do not knock or drop the monitor during operation or transportation.

# Setup

## Contents in Box

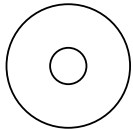
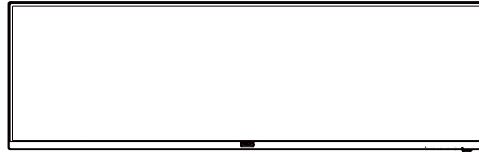

CD Manual



Warranty card

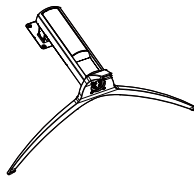

Stand / Base



Stand Screws



Remote control



Batteries



Power Cable



DP Cable



HDMI Cable



USB Cable



USB C-C

★ Not all signal cables will be provided for all countries and regions. Please check with the local dealer or AOC branch office for confirmation.



# Setup Stand & Base

Please setup or remove the base following the steps as below.

## Setup:

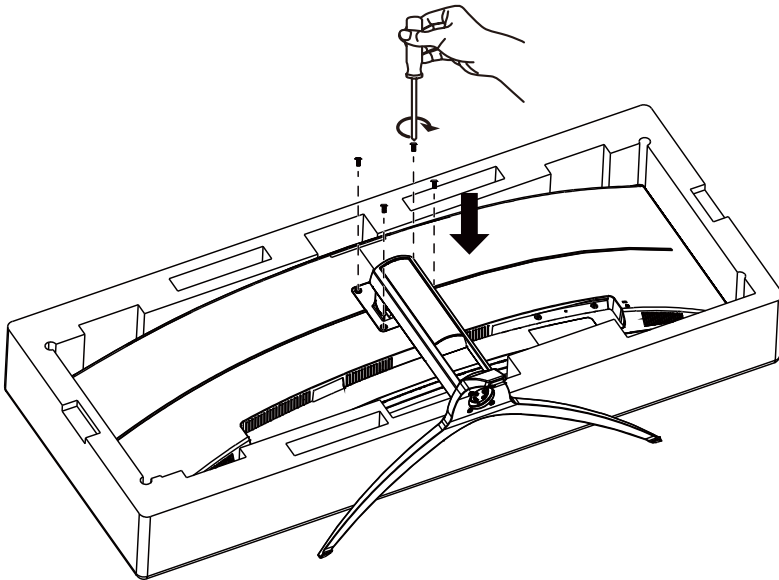

## Remove:

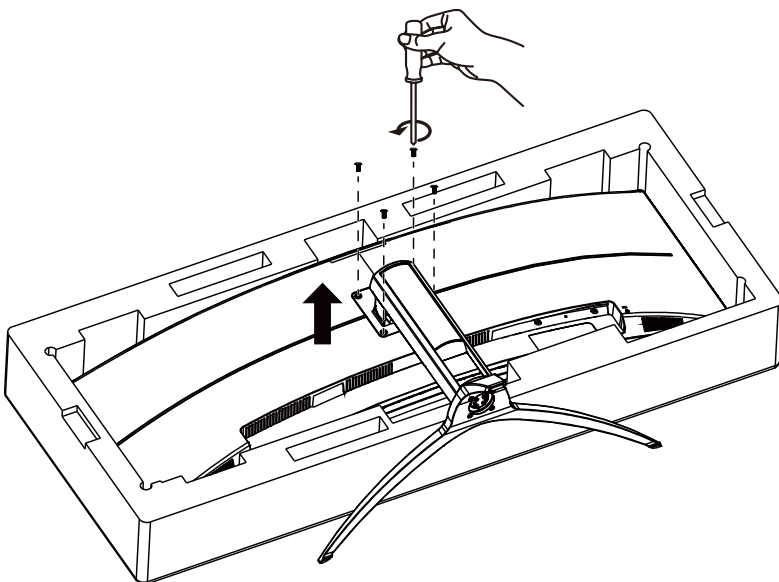

## Adjusting the monitor

For optimal viewing it is recommended to look at the full face of the monitor, then adjust the monitor's angle to your own preference.

Hold the stand so you will not topple the monitor when you change the monitor's angle.

You are able to adjust the monitor as below:

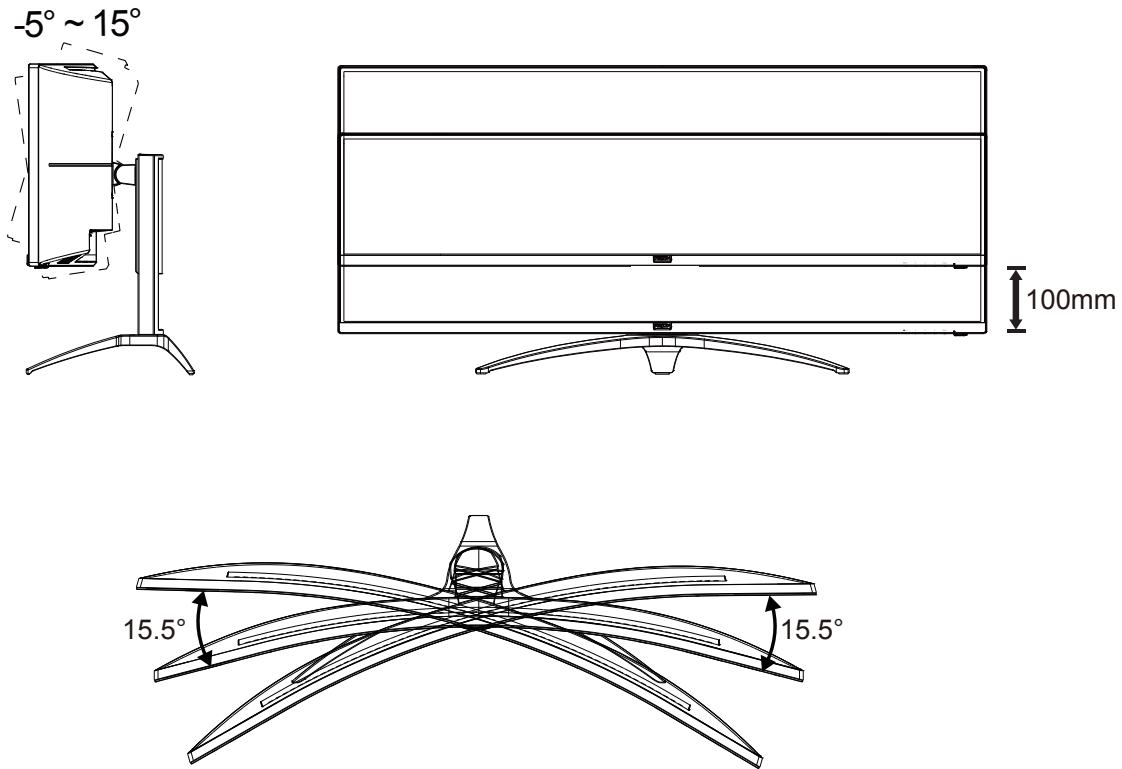

 **NOTE:**

Do not touch the LCD screen when you change the angle. It may cause damage or break the LCD screen.

# Connecting the Monitor

Cable Connections In Back of Monitor and Computer:

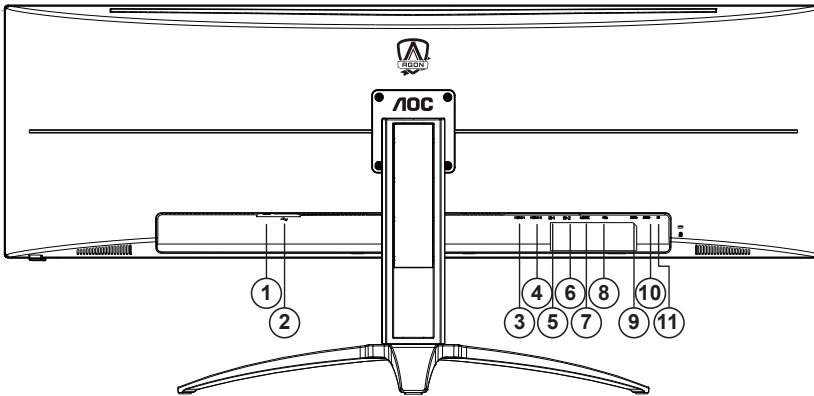

1. Power Switch
2. Power
3. HDMI-1
4. HDMI-2
5. DP-1
6. DP-2
7. USB C
8. USB upstream
9. USB3.2 Gen1 x2
10. USB3.2 Gen1 + fast charging x1
11. Earphone

## Connect to PC

1. Connect the power cord to the back of the display firmly.
2. Turn off your computer and unplug its power cable.
3. Connect the display signal cable to the video connector on the back of your computer.
4. Plug the power cord of your computer and your display into a nearby outlet.
5. Turn on your computer and display.

If your monitor displays an image, installation is complete. If it does not display an image, please refer Troubleshooting.

To protect equipment, always turn off the PC and LCD monitor before connecting.

# Adaptive-Sync function

1. Adaptive-Sync function is working with DP
2. Compatible Graphics Card: Recommend list is as the below, also could be checked by visiting [www.AMD.com](http://www.AMD.com)
  - Radeon™ RX Vega series
  - Radeon™ RX 500 series
  - Radeon™ RX 400 series
  - Radeon™ R9/R7 300 series (excluding R9 370/X)
  - Radeon™ Pro Duo (2016 edition)
  - Radeon™ R9 Nano
  - Radeon™ R9 Fury series
  - Radeon™ R9/R7 200 series (excluding R9 270/X, R9 280/X)

# HDR

It is compatible with input signals in HDR10 format.

The display may automatically activate the HDR function if the player and content are compatible. Please contact the device manufacturer and the content provider for information on the compatibility of your device and content. Please select "OFF" for the HDR function when you have no need for automatic activation function.

## Note:

1. Only the HDMI interface is available and the DisplayPort interface cannot function in WIN10 version V1703.
2. The USB C (DP Alt) interface does not support HDR.
3. The display resolution is set to DP:5120x1440@60Hz, HDMI:3840x1080@60Hz, and HDR is preset to ON. Under these conditions, the screen may slightly dim, indicating HDR has been activated.

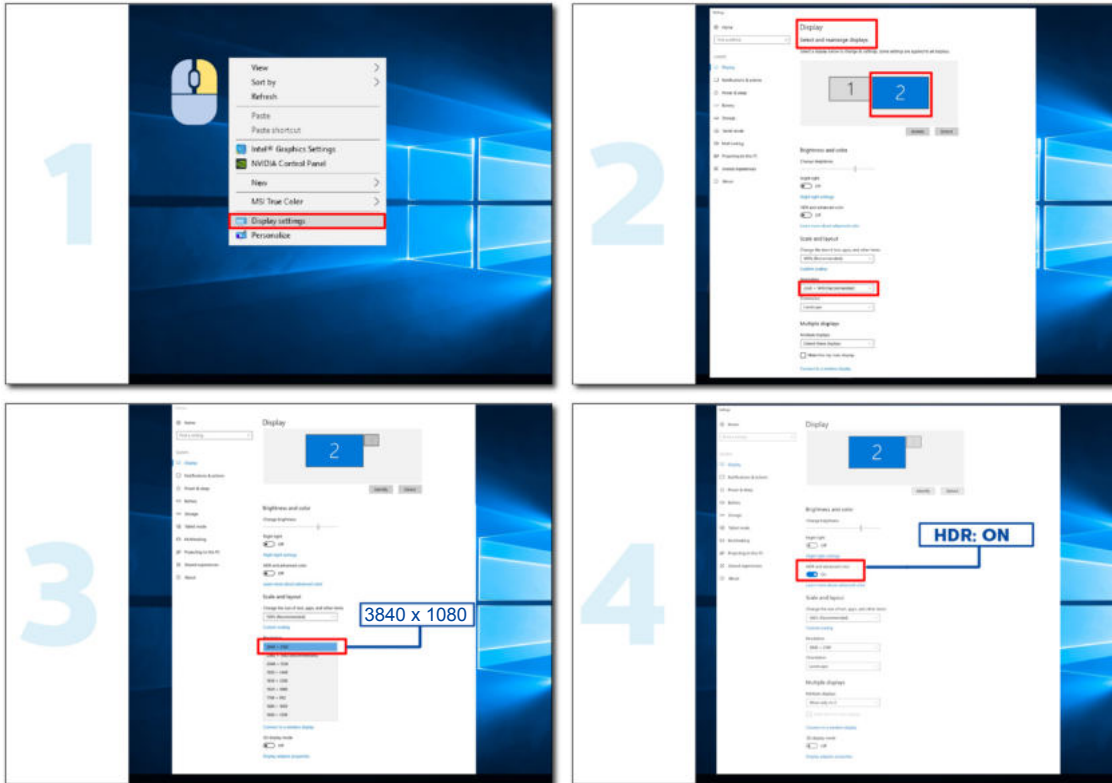

# Adjusting

## Hotkeys

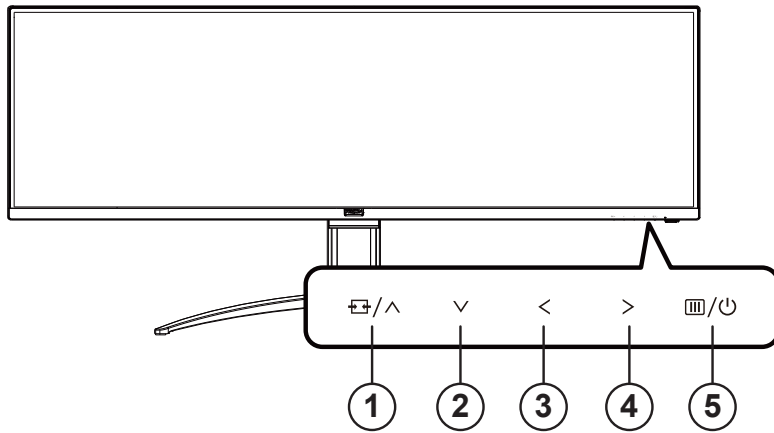

1	Source/Up
2	Dial Point/Down
3	Game Mode/Left
4	Shadow Control /Right
5	Power/ Menu/Enter

### Power/Menu/Enter

Press the Power button to turn on the monitor.

When there is no OSD, Press to display the OSD or confirm the selection. Press about 2 seconds to turn off the monitor.

### Dial Point/Down

When there is no OSD, press Dial Point button to show / hide Dial Point.

### Game Mode/Left

When there is no OSD, press " < Left" key to open game mode function, then press " < Left" or " > Right" key to select game mode (FPS, RTS, Racing, Gamer 1, Gamer 2 or Gamer 3) basing on the different game types.

### Shadow Control/Right

When there is no OSD, Press Shadow Control button to active Shadow Control adjustment bar, Press " > Right" to adjust contrast for clear picture.

### Source/Up

When the OSD is closed, press Source/Up button will be Source hot key function.

## Description of the remote control buttons

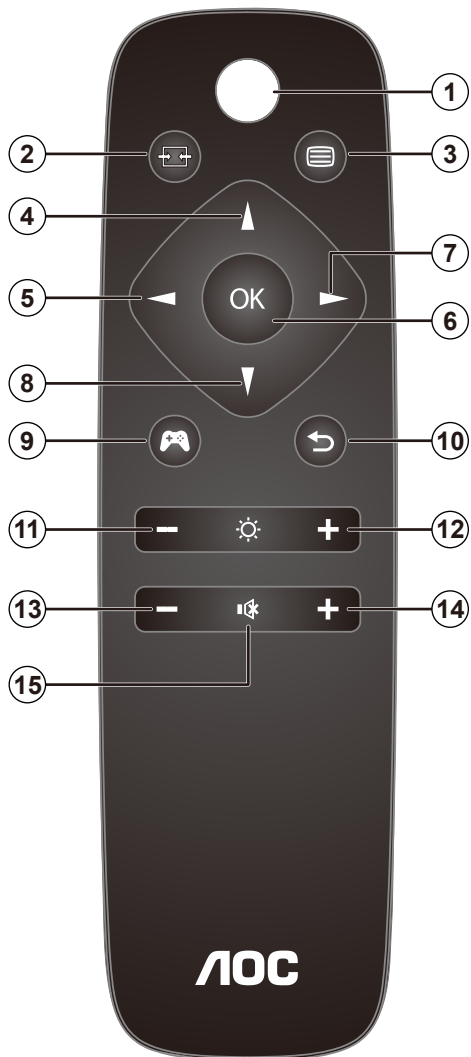

1		Press to switch power on and off.
2		Change the signal input source.
3		Access the OSD menu.
4		Adjust the OSD menu/ Turn up the values.
5		Return to previous OSD level.
6	OK	Confirm the OSD adjustment.
7		Access the OSD menu. Confirm the OSD adjustment.
8		Adjust the OSD menu / Turn down the values.
9		Game Mode.
10		Return to previous OSD level
11		Turn down the brightness
12		Turn up the brightness
13		Turn down the volume
14		Turn up the volume
15		Mute

## OSD Key Guide (Menu)



Enter : Use Enter key to enter the next OSD level  
Move : Use Left / Up / Down key to move OSD selection  
Exit : Use Right key to exit OSD

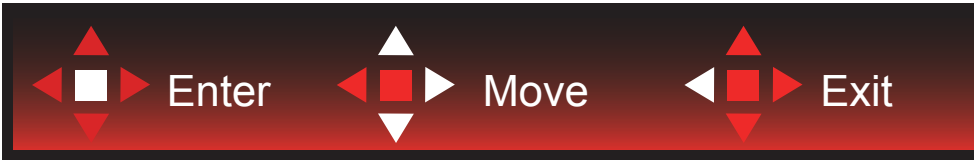

Enter : Use Enter key to enter the next OSD level  
Move : Use Right / Up / Down key to move OSD selection  
Exit : Use Left key to exit OSD

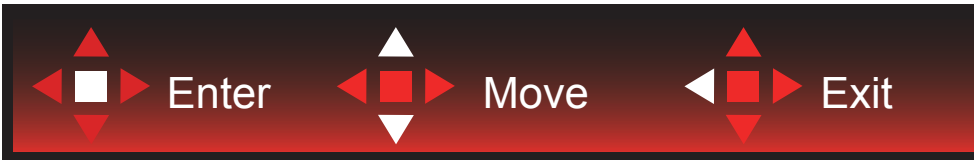

Enter : Use Enter key to enter the next OSD level  
Move : Use Up / Down key to move OSD selection  
Exit : Use Left key to exit OSD

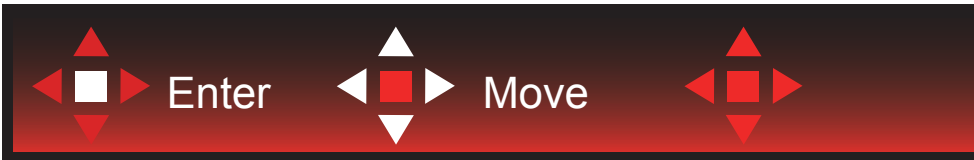

Move : Use Left / Right / Up / Down Key to move OSD selection



Exit : Use Left key to exit OSD to previous OSD level  
Enter : Use Right key to enter next OSD level  
Select : Use Up / Down key to move OSD selection



Enter : Use Enter key to apply the OSD setting and back to previous OSD level  
Select : Use Down key to adjust OSD setting





Select : Use Up / Down key to adjust OSD setting



Enter : Use Enter key to exit OSD to previous OSD level

Select : Use Left / Right key to adjust OSD setting

# OSD Setting

Basic and simple instruction on the control keys.

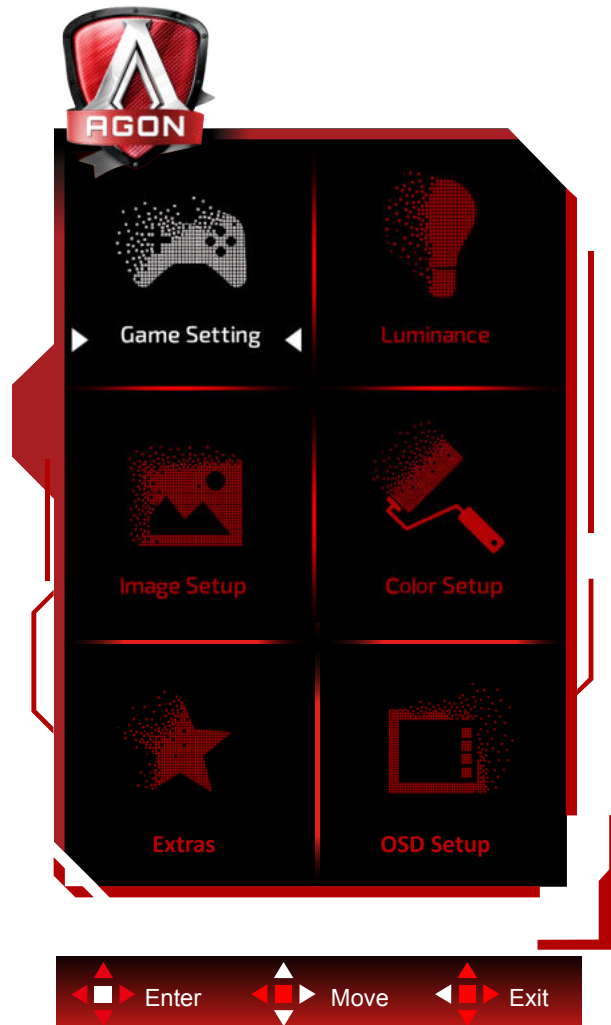

- 1). Press the MENU-button to activate the OSD window.
- 2). Follow Key Guide to move or select (adjust) OSD settings
- 3). OSD Lock/Unlock Function: To lock or unlock the OSD, press and hold the Down-button for 10s while OSD function is not active.

## Notes:

- 1). If the product has only one signal input, the item of "Input Select" is disable to adjust.
- 2). ECO modes (except Standard mode), DCR and DCB mode, for these three states that only one state can exist.

## Game Setting

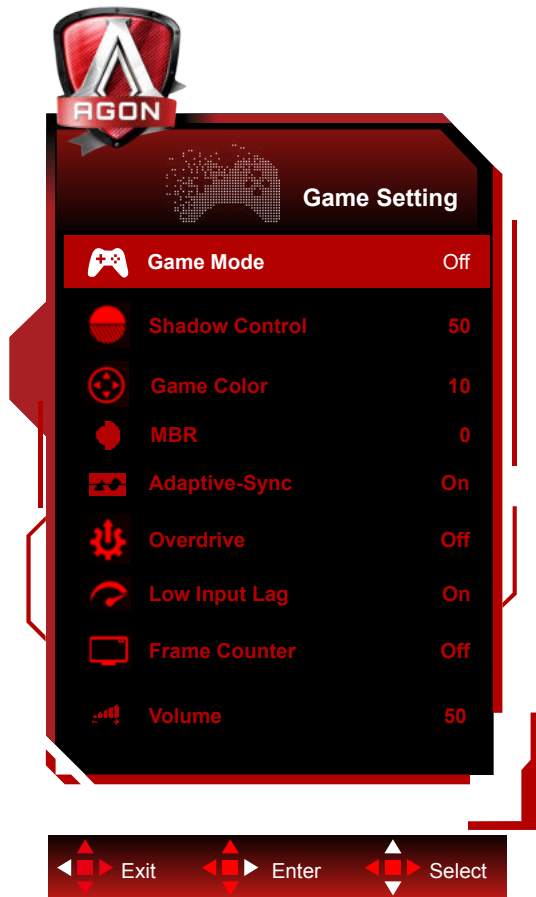

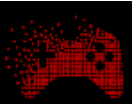
	Game Mode	FPS	For playing FPS (first Person Shooters) games. Improves dark theme black level details.
		RTS	For playing RTS (Real Time Strategy). Improves the image quality.
		Racing	For playing Racing games, Provides fastest response time and high color saturation.
		Gamer 1	User's preference settings saved as Gamer 1.
		Gamer 2	User's preference settings saved as Gamer 2.
		Gamer 3	User's preference settings saved as Gamer 3.
		off	No optimization by Smart image game
	Shadow Control	0-100	Shadow Control Default is 50, then end-user can adjust from 50 to 100 or 0 to increase contrast for clear picture. 1. If picture is too dark to be saw the detail clearly, adjusting from 50 to 100 for clear picture. 2. If picture is too white to be saw the detail clearly, adjusting from 50 to 0 for clear picture
	Game Color	0-20	Game Color will provide 0-20 level for adjusting saturation to get better picture.
	MBR	0-20	Adjust the Motion Blur Reduction.
Adaptive-Sync	On / Off	Disable or Enable Adaptive-Sync. Adaptive-Sync Run Reminder: When the Adaptive-Sync feature is enabled, there may be flashing in some game environments.	

	Overdrive	Weak/Medium/ Strong/Boost/Off	Adjust the response time. Notes: 1. If the user adjusts OverDrive to a “strong” rating, a blurred image may be displayed. Users can adjust the OverDrive rating or turn it off according to their preferences.
	Low Input lag	On / Off	Turn off frame buffer to decrease input lag
	Frame Counter	Off / Right-Up / Right-Down / Left- Down / Left-Up	Display V frequency on the corner selected (Frame counter feature only works with AMD graphic card.)
	Volume	0-100	Adjust volume setting

**Notes:**

- 1). The function MBR and Overdrive Boost are available only when Adaptive-Sync is off, Low Input lag is on and the vertical frequency is up to 5120x1440@100Hz/120Hz.
- 2). The screen brightness will be reduced when adjusting MBR or Over driver setting to Boost.
- 3). When “HDR Mode” is set to “non-off” under “Image Settings”, “Game Mode”, “Shadow Control”, “Game Color” items cannot be adjusted.
- 4). When “HDR” is set to “non-off” under “Image Settings”, “Game Mode”, “Shadow Control”, “Game Color”, “MBR” items cannot be adjusted under “Game Settings”. “Boost” under “Overdrive” is not available.

# Luminance

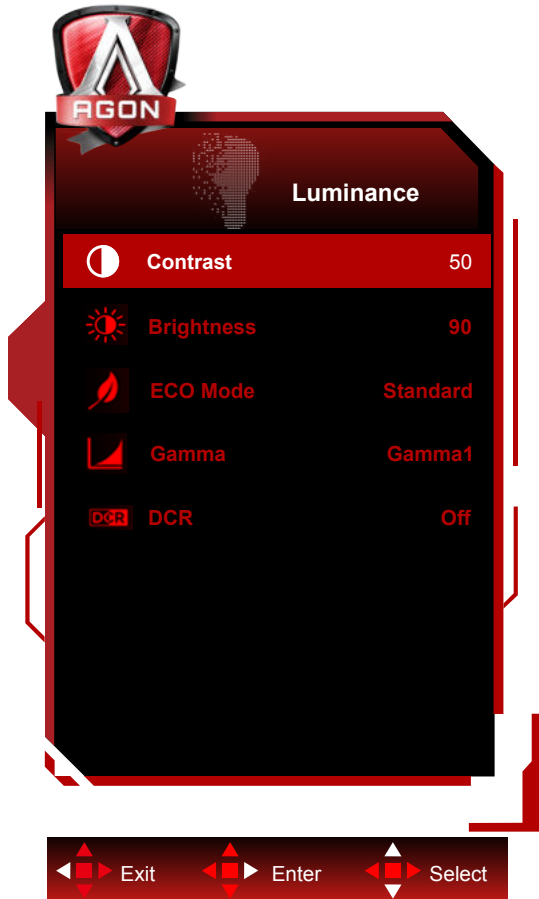

	Contrast	0-100	Contrast from Digital-register.	
	Brightness	0-100	Backlight Adjustment	
	Eco mode	Standard		Standard Mode
		Text		Text Mode
		Internet		Internet Mode
		Game		Game Mode
		Movie		Movie Mode
		Sports		Sports Mode
		Reading		Reading Mode
	Gamma	Uniformity		Uniformity Mode
		Gamma1		Adjust to Gamma 1
Gamma2			Adjust to Gamma 2	
Gamma3		Adjust to Gamma 3		
DCR	Off/On		Disable/ Enable dynamic contrast ratio	

**Note:**

- 1). When “HDR Mode” is set to “non-off” under “Image Settings”, “Contrast”, “Eco mode”, “Gamma” items cannot be adjusted.
- 2). When “HDR” is set to “non-off” under “Image Settings”, all items under “Luminance” cannot be adjusted.

# Image Setup

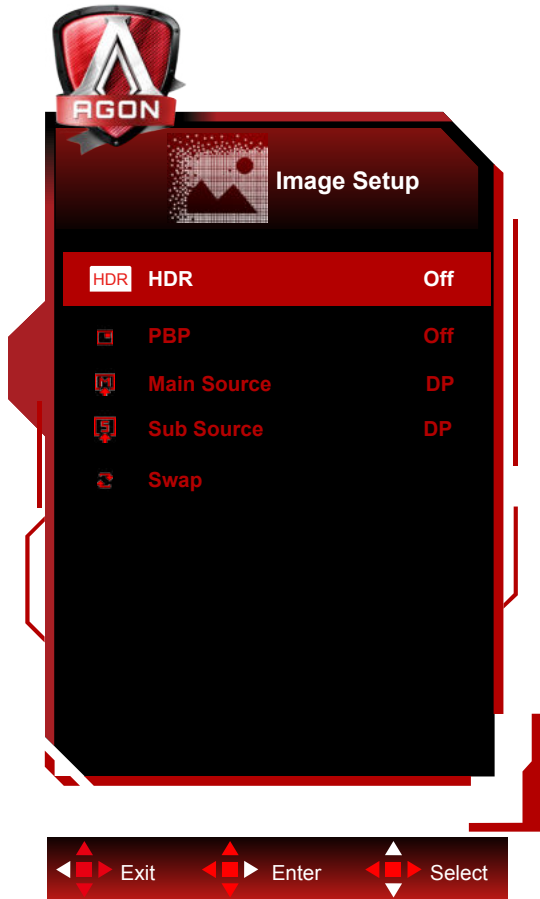

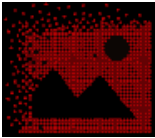
	HDR	Off	Adjust HDR Mode. Note: When HDR is detected, the HDR option is displayed for adjustment.
		DisplayHDR	
		HDR Picture	
		HDR Movie	
		HDR Game	
	HDR Mode	Off	Adjust HDR Mode. Note: When HDR is not detected, the HDR Mode option is displayed for adjustment.
		HDR Picture	
		HDR Movie	
		HDR Game	
	PBP	Off / PBP	Disable/ Enable the PBP function.
Main Source		Select the main source.	
Sub Source		Select the sub source.	
Swap		Swap the screen source.	

Note:  
When PBP is turned on, "HDR Mode" and "HDR" are not adjustable.

## Color Setup



	LowBlue Mode	Off / Multimedia / Internet / Office / Reading		Decrease blue light wave by controlling color temperature.
	Color Temp.	Warm		Recall Warm Color Temperature from EEPROM.
		Normal		Recall Normal Color Temperature from EEPROM.
		Cool		Recall Cool Color Temperature from EEPROM.
		sRGB		Recall SRGB Color Temperature from EEPROM.
		User		Restore User Color Temperature from EEPROM.
	DCB Mode	Full Enhance	On or Off	Disable or Enable Full Enhance Mode
		Nature Skin	On or Off	Disable or Enable Nature Skin Mode
		Green Field	On or Off	Disable or Enable Green Field Mode
		Sky-blue	On or Off	Disable or Enable Sky-blue Mode
		AutoDetect	On or Off	Disable or Enable AutoDetect Mode
	DCB Demo		On or Off	Disable or Enable Demo
	Red		0-100	Red gain from Digital-register.
Green		0-100	Green gain from Digital-register.	
Blue		0-100	Blue gain from Digital-register.	

### Note:

When the HDR/HDR Mode setting under “Image Setup” is set to “non-Off”, all items under “Color Setup” cannot be adjusted.

## Extra

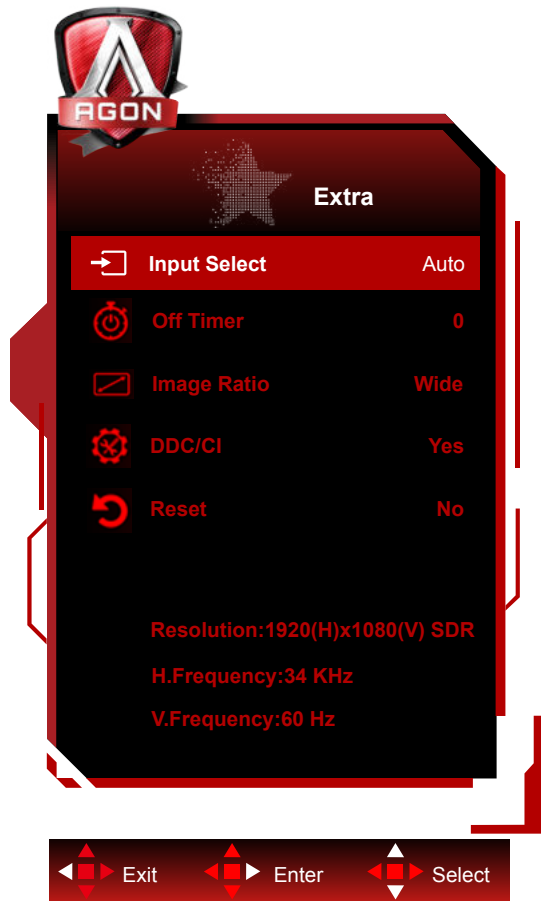

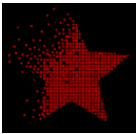
	Input Select	Auto / HDMI1 / HDMI2 / DP1 / DP2 / USB C*	Select Input Signal Source
	Off timer	0-24hrs	Select DC off time
	Image Ratio	Wide / 4:3 / 1:1 / 17"(4:3) / 19"(4:3) / 19"(5:4) / 19"W(16:10) / 21.5"W(16:9) / 22"W(16:10) / 23"W(16:9) / 23.6"W(16:9) / 24"W(16:9) / 27"W(16:9)	Select image ratio for display.
	DDC/CI	Yes or No	Turn ON/OFF DDC/CI Support
	Reset	Yes or No	Reset the menu to default

\*: The device needs to support USB C interface video transmission (DP Alt).



## OSD Setup

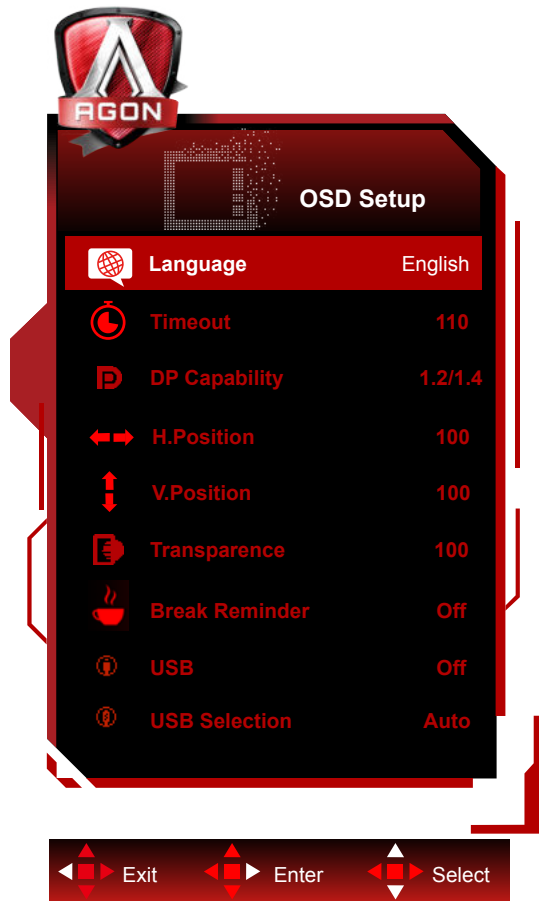

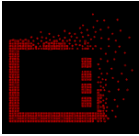
	Language		Select the OSD language
	Timeout	5-120	Adjust the OSD Timeout
	DP Capability	1.1/1.2/1.4	If the DP video content supports 1.2/1.4, please select 1.2/1.4 for DP Capability, otherwise, please select 1.1. Please be noted that only 1.2/1.4 support HDR function.
	H. Position	0-100	Adjust the horizontal position of OSD
	V. Position	0-100	Adjust the vertical position of OSD
	Transparence	0-100	Adjust the transparence of OSD
	Break Reminder	on /off	Break reminder if the user continuously work for more than 1hrs
	USB	3.2Gen1 / 2.0 / Off	Select USB type.
	USB Selection	Auto / USB C / USB up	Select USB input source.

### Notes:

When the USB is set to USB3.2 Gen1, the max resolution of USB C interface is 2560x1440@60Hz or 3840x1080@60Hz. When the USB is set to USB2.0 or off, the max resolution of USB C interface is 2560x1440@120Hz or 3840x1080@120Hz.

## LED Indicator

Status	LED Color
Full Power Mode	White
Active-off Mode	White (blinking)

# Troubleshoot

Problem & Question	Possible Solutions
<b>Power LED Is Not ON</b>	Make sure the power button is ON and the Power Cord is properly connected to a grounded power outlet and to the monitor.
<b>No images on the screen</b>	<ul style="list-style-type: none"> <li>• Is the power cord connected properly? Check the power cord connection and power supply.</li> <li>• Is the cable connected correctly? (Connected using the HDMI cable) Check the HDMI cable connection. (Connected using the DP cable) Check the DP cable connection. *HDMI/DP input is not available on every model.</li> <li>• If the power is on, reboot the computer to see the initial screen (the login screen), which can be seen. If the initial screen (the login screen) appears, boot the computer in the applicable mode (the safe mode for Windows 7/8/10) and then change the frequency of the video card. (Refer to the Setting the Optimal Resolution) If the initial screen (the login screen) does not appear, contact the Service Center or your dealer.</li> <li>• Can you see "Input Not Supported" on the screen? You can see this message when the signal from the video card exceeds the maximum resolution and frequency that the monitor can handle properly. Adjust the maximum resolution and frequency that the monitor can handle properly.</li> <li>• Make sure the AOC Monitor Drivers are installed.</li> </ul>
<b>Picture Is Fuzzy &amp; Has Ghosting Shadowing Problem</b>	Adjust the Contrast and Brightness Controls. Press to auto adjust. Make sure you are not using an extension cable or switch box. We recommend plugging the monitor directly to the video card output connector on the back.
<b>Picture Bounces, Flickers Or Wave Pattern Appears In The Picture</b>	Move electrical devices that may cause electrical interference as far away from the monitor as possible. Use the maximum refresh rate your monitor is capable of at the resolution you are using.
<b>Monitor Is Stuck In Active Off-Mode"</b>	The Computer Power Switch should be in the ON position. The Computer Video Card should be snugly fitted in its slot. Make sure the monitor's video cable is properly connected to the computer. Inspect the monitor's video cable and make sure no pin is bent. Make sure your computer is operational by hitting the CAPS LOCK key on the keyboard while observing the CAPS LOCK LED. The LED should either turn ON or OFF after hitting the CAPS LOCK key.
<b>Missing one of the primary colors (RED, GREEN, or BLUE)</b>	Inspect the monitor's video cable and make sure that no pin is damaged. Make sure the monitor's video cable is properly connected to the computer.
<b>Screen image is not centered or sized properly</b>	Adjust H-Position and V-Position or press hot-key (AUTO).
<b>Picture has color defects (white does not look white)</b>	Adjust RGB color or select desired color temperature.
<b>Horizontal or vertical disturbances on the screen</b>	Use Windows 7/8/10 shut-down mode to adjust CLOCK and FOCUS. Press to auto-adjust.

# Specification

## General Specification

Panel	Model name	AG493UCX		
	Driving system	TFT Color LCD		
	Viewable Image Size	124 cm diagonal		
	Pixel pitch	0.2331mm(H) x 0.2331mm(V)		
	Video	HDMI /DP/USB-C		
	Display Color	16.7M Colors		
Others	Horizontal scan range	30k-200kHz		
	Horizontal scan Size(Maximum)	1193.472mm		
	Vertical scan range	48-120Hz		
	Vertical Scan Size(Maximum)	335.664mm		
	Optimal preset resolution	2560x1440@60Hz (HDMI2.0/USB C) 3840x1080@60Hz (HDMI2.0/USB C) 5120x1440@60Hz (DP1.4)		
	Max resolution	2560x1440@120Hz (HDMI2.0/USB C) 3840x1080@120Hz (HDMI2.0/USB C) 5120x1440@120Hz (DP1.4) Notes: 1. Use 5120x 1440 for the best results. 2. When the USB is set to USB3.2 Gen1, the max resolution of USB C interface is 2560x1440@60Hz or 3840x1080@60Hz.		
	Plug & Play	VESA DDC2B/CI		
	Connector	HDMI(HDR)x2, DP(HDR)x2, USBx3, USB Up, USB C(DP Alt), Earphone out		
	Power Source	100-240V~, 50/60Hz, 3A		
	Power Consumption	Typical(default brightness and contrast)	60 W	
Max. (brightness = 100, contrast =100)		≤230W		
Power saving		≤ 0.5 W		
USB C	USB-C	Reversible plug connector		
	Super speed	Data and Video transfer		
	DP	Built-in DisplayPort Alt mode		
	Power Delivery	USB PD version 2.0		
	Max power delivery	Up to 65W (5V/3A, 7V/3A, 9V/3A, 10V/3A, 12V/3A, 15V/3A, 20V/3.25A)		
Environmental	Temperature	Operating	0° ~ 40°	
		Non-Operating	-25° ~ 55°	
	Humidity	Operating	10% ~ 85% (non-condensing)	
		Non-Operating	5% ~ 93% (non-condensing)	
	Altitude	Operating	0~ 5000 m (0~ 16404ft )	
		Non-Operating	0~ 12192m (0~ 40000ft )	

## Preset Display Modes

STANDARD	RESOLUTION	HORIZONTAL FREQUENCY(kHz)	VERTICAL FREQUENCY(Hz)
VGA	640x480@60Hz	31.469	59.94
VGA	640x480@67Hz	35	66.667
VGA	640x480@72Hz	37.861	72.809
VGA	640x480@75Hz	37.5	75
VGA	640x480@100Hz	51.08	99.769
VGA	640x480@120Hz	61.91	119.518
DOS MODE	720x400@70Hz	31.469	70.087
DOS MODE	720x480@60Hz	29.855	59.710
SD	720x576@50Hz	31.25	50
SVGA	800x600@56Hz	35.156	56.25
SVGA	800x600@60Hz	37.879	60.317
SVGA	800x600@72Hz	48.077	72.188
SVGA	800x600@75Hz	46.875	75
SVGA	800x600@100Hz	63.684	99.662
SVGA	800x600@120Hz	76.302	119.97
SVGA	832x624@75Hz	49.725	74.551
XGA	1024x768@60Hz	48.363	60.004
XGA	1024x768@70Hz	56.476	70.069
XGA	1024x768@75Hz	60.023	75.029
XGA	1024x768@100Hz	81.577	99.972
XGA	1024x768@120Hz	97.551	119.989
SXGA	1280x1024@60Hz	63.981	60.02
SXGA	1280x1024@75Hz	79.975	75.025
Full HD	1920x1080@60Hz	67.5	60
FHD	1920x1080@100Hz	113.221	99.93
FHD	1920x1080@120Hz	137.26	119.982
QHD	2560x1440@60Hz	88.787	59.951
QHD	2560x1440@75Hz	111.028	74.968
QHD	2560x1440@120Hz	182.817	119.880
Dual FHD	3840x1080@60Hz	66.625	59.968
Dual FHD	3840x1080@120Hz	133.32	120
Qual QHD	5120x1440@60Hz (DP)	88.826	59.977
Qual QHD	5120x1440@70Hz (DP)	104.119	70.303
Qual QHD	5120x1440@75Hz (DP)	111.075	75
Qual QHD	5120x1440@100Hz (DP)	148.1	100
Qual QHD	5120x1440@120Hz (DP)	177.72	120

# Pin Assignments

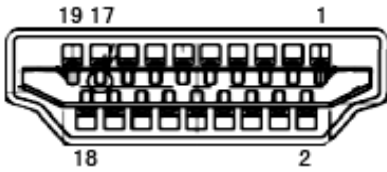

19-Pin Color Display Signal Cable

Pin No.	Signal Name	Pin No.	Signal Name	Pin No.	Signal Name
1.	TMDS Data 2+	9.	TMDS Data 0-	17.	DDC/CEC Ground
2.	TMDS Data 2 Shield	10.	TMDS Clock +	18.	+5V Power
3.	TMDS Data 2-	11.	TMDS Clock Shield	19.	Hot Plug Detect
4.	TMDS Data 1+	12.	TMDS Clock-		
5.	TMDS Data 1Shield	13.	CEC		
6.	TMDS Data 1-	14.	Reserved (N.C. on device)		
7.	TMDS Data 0+	15.	SCL		
8.	TMDS Data 0 Shield	16.	SDA		

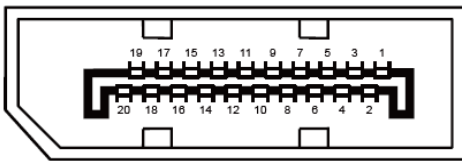

20-Pin Color Display Signal Cable

Pin No.	Signal Name	Pin No.	Signal Name
1	ML_Lane 3 (n)	11	GND
2	GND	12	ML_Lane 0 (p)
3	ML_Lane 3 (p)	13	CONFIG1
4	ML_Lane 2 (n)	14	CONFIG2
5	GND	15	AUX_CH(p)
6	ML_Lane 2 (p)	16	GND
7	ML_Lane 1 (n)	17	AUX_CH(n)
8	GND	18	Hot Plug Detect
9	ML_Lane 1 (p)	19	Return DP_PWR
10	ML_Lane 0 (n)	20	DP_PWR

# Plug and Play

## Plug & Play DDC2B Feature

This monitor is equipped with VESA DDC2B capabilities according to the VESA DDC STANDARD. It allows the monitor to inform the host system of its identity and, depending on the level of DDC used, communicate additional information about its display capabilities.

The DDC2B is a bi-directional data channel based on the I2C protocol. The host can request EDID information over the DDC2B channel.