



User's Manual

FlexScan® EV3240X

Color LCD Monitor

Important

Please read this "User's Manual", and "PRECAUTIONS" (separate volume) carefully to familiarize yourself with safe and effective usage.

- See the Setup Guide for monitor installation and connection.
- For the latest product information including the "User's Manual", refer to our web site:
www.eizoglobal.com

Location of Caution Statement

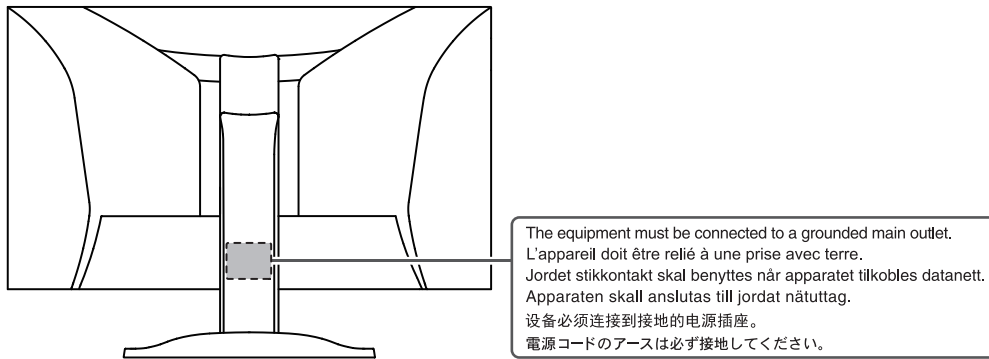

This product has been adjusted specifically for use in the region to which it was originally shipped.
If operated outside this region, the product may not perform as stated in the specifications.

No part of this manual may be reproduced, stored in a retrieval system, or transmitted, in any form or by any means, electronic, mechanical, or otherwise, without the prior written permission of EIZO Corporation.

EIZO Corporation is under no obligation to hold any submitted material or information confidential unless prior arrangements are made pursuant to EIZO Corporation's receipt of said information. Although every effort has been made to ensure that this manual provides up-to-date information, please note that EIZO product specifications are subject to change without notice.

About This Product

About the Usage of This Product

- Aside from creating documents, viewing multimedia content, and other general purposes, this product is also suited to applications such as creating CAD data and other drawings (Assuming usage of approximately 12 hours per day).
- If using this product for the following kinds of applications, where an extremely high degree of reliability and safety is required, then measures should be in place to maintain safety while using this product:
 - Transportation equipment (ships, aircraft, trains, and automobiles)
 - Safety devices (Disaster prevention systems, security control systems, etc.)
 - Life-critical devices (medical devices, such as life-support devices and operating room devices)
 - Nuclear energy control devices (Nuclear energy control systems, security control systems of nuclear facilities, etc.)
 - Major system communication devices (operation control systems of transportation systems, air traffic control systems, etc.)
- This product has been adjusted specifically for use in the region to which it was originally shipped. If the product is used outside the region, it may not operate as specified in the specifications.
- This product may not be covered by warranty for uses other than those described in this manual.
- The specifications noted in this manual are only applicable when the following are used:
 - Power cords provided with the product
 - Signal cables specified by us
- Only use optional products manufactured or specified by us with this product.

About the LCD Panel

- It takes about 30 minutes (under our measurement conditions) for the monitor display to stabilize. Please wait 30 minutes or more after the monitor power has been turned on, and then adjust the monitor.
- Monitors should be set to a lower brightness to prevent a loss in the screen quality caused by long-term use and to maintain stable use.
- When the screen image is changed after displaying the same image for extended periods of time, an afterimage may remain. Use the screensaver or power save function to avoid displaying the same image for extended periods of time. An afterimage may appear even after a short time period has elapsed depending on the displayed image. To remove such a phenomenon, change the image or keep the power turned off for several hours.
- If the monitor displays continuously over a long period of time, smudges or burn-in may appear. To maximize the life of the monitor, we recommend the monitor be turned off periodically.
- The LCD panel is manufactured using high-precision technology. Although, missing pixels or lit pixels may appear on the LCD panel, this is not a malfunction. Percentage of effective dots: 99.9994 % or higher.
- The backlight of the LCD panel has a fixed lifetime. Depending on the usage pattern, such as usage for long continuous periods, the lifespan of the backlight may run out

sooner, requiring replacement. When the screen becomes dark or begins to flicker, please contact your local EIZO representative.

- Do not press hard on the surface or outer frame of the LCD panel, as this may result in display malfunctions, such as interference patterns, etc. If pressure is continuously applied to the LCD panel surface, the liquid crystal may deteriorate or the LCD panel may be damaged. (If the pressure marks remain on the LCD panel, leave the monitor with a black or white screen. The symptom may disappear.)
- Do not scratch or press on the LCD panel with any sharp objects, at this may result in damage to the LCD panel. Do not attempt to brush with tissues as this may scratch the panel.

About the Installation

- If you place this product on a lacquer-coated desk, the color may adhere to the bottom of the stand due to the composition of the rubber. Check the desk surface before use.
- Dew condensation may form on the surface or interior of this product when it is brought into a cold room, when the temperature suddenly rises, or when it is moved from a cold room to a warm room. In that case, do not turn the product on. Instead wait until the dew condensation disappears, otherwise it may cause some damage to the product.

Cleaning

- Periodic cleaning is recommended to keep the product looking new and to prolong its operation lifetime.
- Stains on the product can be removed by moistening part of a soft cloth with water or by using our ScreenCleaner and gently wiping.

Attention
<ul style="list-style-type: none">• Do not let liquids come into direct contact with the product. If it does, wipe it off immediately.• Do not allow liquids to get into gaps or inside the product.• When using chemicals for cleaning or disinfection, chemicals such as alcohol and disinfectant may cause gloss variation, tarnishing, and fading of the product, and also quality deterioration of the displayed image. Do not use chemicals on a frequent basis.• Never use a thinner, benzene, wax, or abrasive cleaner as they may damage the product.• For more information on cleaning and disinfection, please refer to our web site. How to check: Access www.eizoglobal.com and type "disinfect" in the site search box to search.

To Use the Monitor Comfortably

- An excessively dark or bright screen may affect your eyes. Adjust the brightness of the monitor according to the environmental conditions.
- Staring at the monitor for a long time tires your eyes. Take a 10-minute rest every hour.
- Look at the screen from a proper distance and from a proper angle.

CONTENTS

Location of Caution Statement	2
About This Product	3
About the Usage of This Product	3
About the LCD Panel	3
About the Installation.....	4
Cleaning	4
To Use the Monitor Comfortably	4
1 Introduction	7
1.1 Features	7
1.1.1 Two Window Display.....	7
1.1.2 Supports Video Display and Power Supply with a Single USB Type-C® (hereinafter USB-C®) Cable	7
1.1.3 High Degree of Flexibility for Installation.....	7
1.1.4 Reduction of Power Consumption	8
1.1.5 Realizing More Convenient Operations Using Screen InStyle.....	8
1.1.6 Docking Station Function	9
1.2 Controls and Functions	10
1.2.1 Front.....	10
1.2.2 Rear	11
1.3 Supported Resolutions	13
2 Basic Adjustment/Setting	15
2.1 Switch Operation Method.....	15
2.2 Switching Input Signals	15
2.3 Switching Display Modes (Color Modes)	16
2.3.1 Color Modes.....	16
2.4 Conserving Energy.....	16
2.5 Adjusting Brightness	18
2.6 Adjusting Volume	18
3 Advanced Adjustments/Settings	19
3.1 Basic Operation of the Setting Menu	19
3.2 Setting Menu Functions	20
3.2.1 Color	20
3.2.2 Signal	23
3.2.3 Preferences.....	25
3.2.4 Languages	27
3.2.5 Information.....	28
4 Connecting Multiple PCs	29
4.1 Connecting Multiple PCs.....	29

CONTENTS

4.2	Using PbyP Display.....	30
4.3	Using PinP Display.....	31
4.4	Linking the Input Signal and USB Port.....	32
4.4.1	Linking.....	32
4.4.2	Switching USB Ports.....	33
5	Administrator Settings.....	34
5.1	Basic Operation of the "Administrator Settings" Menu.....	34
5.2	Functions of the "Administrator Settings" Menu.....	35
6	Troubleshooting.....	38
6.1	No Picture.....	38
6.2	Imaging Problems.....	39
6.3	Other Problems.....	40
7	Attaching/Removing the Stand.....	43
7.1	Removing the Stand.....	43
7.2	Attaching the Optional Arm.....	44
7.3	Attaching the Original Stand.....	46
8	Reference.....	47
8.1	Using the Docking Station Function.....	47
8.2	Specifications.....	49
8.2.1	LCD Panel.....	49
8.2.2	Video Signals.....	49
8.2.3	USB.....	49
8.2.4	Audio.....	50
8.2.5	Network.....	50
8.2.6	Power.....	50
8.2.7	Physical Specifications.....	50
8.2.8	Operating Environmental Requirements.....	51
8.2.9	Transportation / Storage Environmental Requirements.....	51
8.2.10	Accessories.....	51
	Appendix.....	52
	Trademark.....	52
	License.....	52

1 Introduction

Thank you very much for choosing an EIZO color LCD monitor.

1.1 Features

1.1.1 Two Window Display

PbyP (Picture by Picture) and PinP (Picture in Picture) functions are available to split the screen into left and right and display two input signals at the same time.

1.1.2 Supports Video Display and Power Supply with a Single USB Type-C® (hereinafter USB-C®) Cable

This product is equipped with a USB-C connector and supports the transmission of video signals (DisplayPort™ Alt Mode) as well as power supply (USB Power Delivery).

It supplies a maximum of 94 W of power to a connected notebook PC when used as an external monitor.

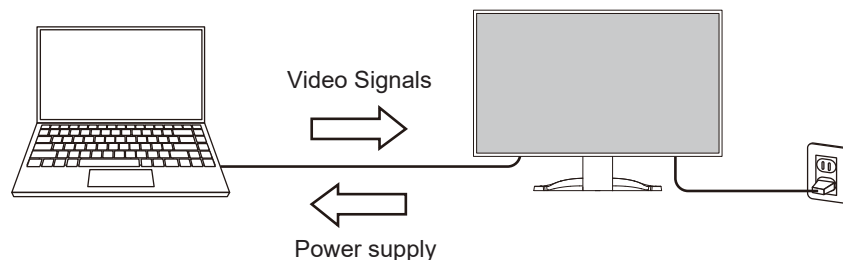

Note

- To display video signals, the connected device must support transmission of video signals (DisplayPort Alt Mode).
- To use the charging function, the connected device must support device charging by using USB Power Delivery.
- Only when the following USB cables are used, a maximum of 94 W of power can be supplied:
 - CC150SS81G-5A or CC150SS81GW-5A (Included)
 - CC100 (Optional accessory)
- Connected devices can be charged even when the monitor is in power saving mode.
- When "Compatibility Mode" is set to "On" in the "Administrator Settings" menu, connected devices can be charged even when the power of the monitor is turned off (except when the main power switch is off).

1.1.3 High Degree of Flexibility for Installation

- This product can be used as an external monitor for a notebook PC.



- By attaching the monitor to an arm, the screen can be used in a multi-monitor configuration benefiting from the feature of framelessness on all four sides (see [7.2 Attaching the Optional Arm](#) [▶ 44]).

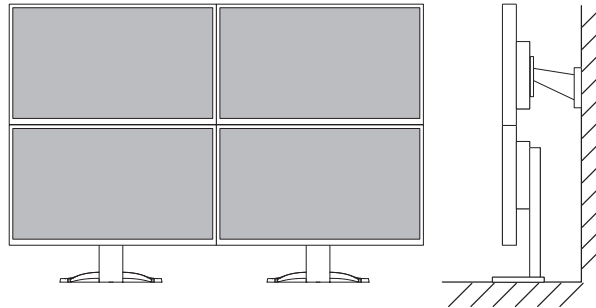

1.1.4 Reduction of Power Consumption

This product provides a function that automatically adjusts the screen brightness to reduce power consumption ^{*1}. Power Reduction, CO₂ Reduction, and Eco Performance Level can be checked on the "EcoView Settings" menu (see [2.4 Conserving Energy](#) [▶ 16]).

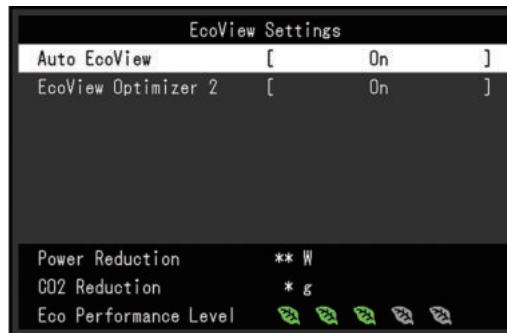

- Auto EcoView
The ambient light sensor on the front of the monitor detects the ambient brightness to automatically adjust the screen brightness to a comfortable level.
- EcoView Optimizer 2
The monitor automatically adjusts the screen brightness according to the white level of the input signal. This function can reduce power consumption while maintaining the brightness specified by the input signal.

^{*1} Reference values

Maximum power consumption: 196 W (when a USB device is connected and the speakers are working), standard power consumption: 18 W (brightness 120 cd/m², when no USB device is connected and the speakers are not working, at default settings)

1.1.5 Realizing More Convenient Operations Using Screen InStyle

The "Screen InStyle" monitor control utility enables you to use the monitor more conveniently.

- The monitor color mode can be switched automatically to suit the software to be used.
- You can switch input signals using the shortcut keys on the keyboard.
- When multiple monitors are installed, you can turn the power on and off or change the color mode of all monitors at the same time.

Note

- Screen InStyle can be downloaded from our web site (www.eizoglobal.com).
- The Windows operating systems are only supported.

1.1.6 Docking Station Function

This product is equipped with a LAN port and USB hub so that it can be used as a docking station. By connecting a USB-C cable, you can create a stable network environment even on notebook PCs or tablet devices that are not equipped with LAN ports. You can also use USB-compatible peripheral devices and charge smartphones (see [8.1 Using the Docking Station Function](#) [▶ 47]).

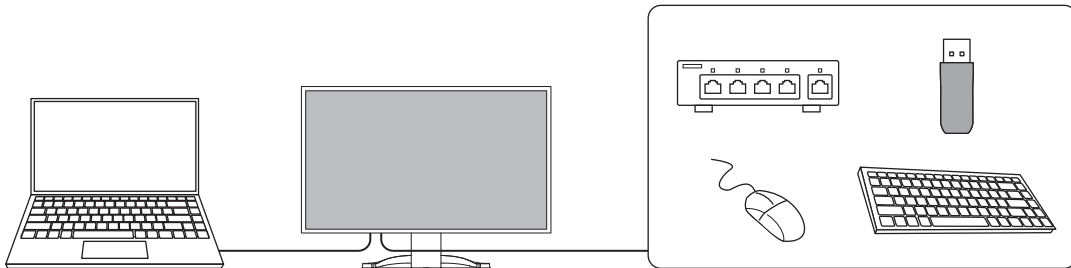

1.2 Controls and Functions

1.2.1 Front

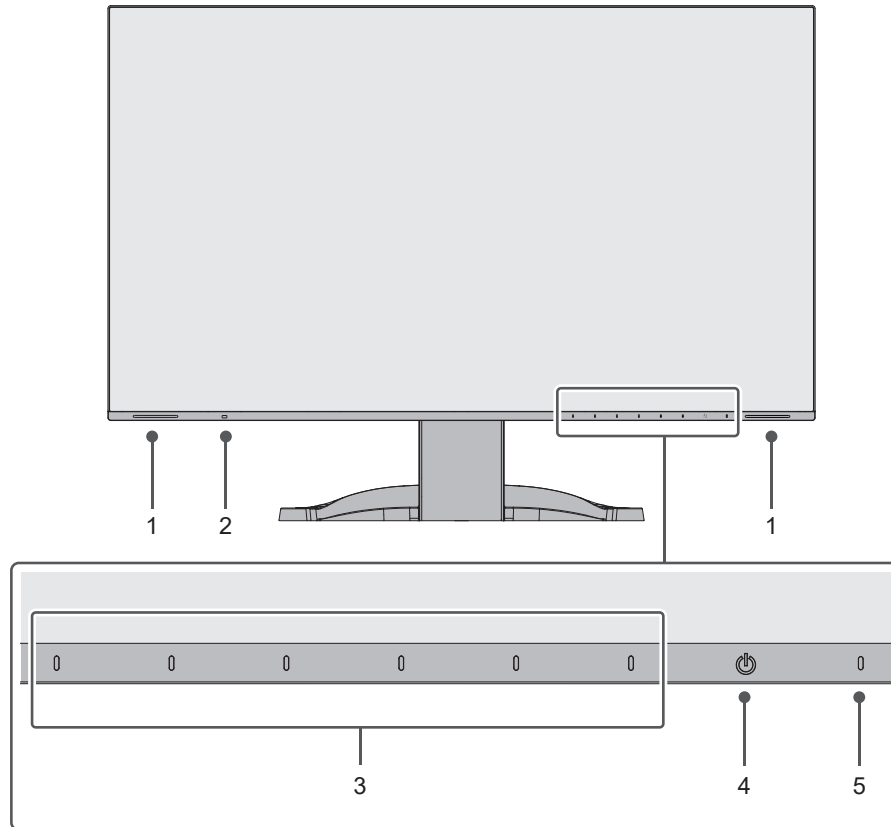

1. Speakers	Outputs audio.
2. Ambient light sensor	Detects ambient brightness. If you use Auto EcoView, the screen brightness is automatically adjusted according to the ambient brightness (see Auto EcoView [▶ 17]).
3. Operation switches	Displays menus. Operate the switches according to the operation guide (see 3.1 Basic Operation of the Setting Menu [▶ 19]).
4. Power switch	Turns the power on or off.
5. Power indicator	Indicates the monitor's operation status. White: Normal operation mode Orange: Power saving mode OFF: Main power/power off

1.2.2 Rear

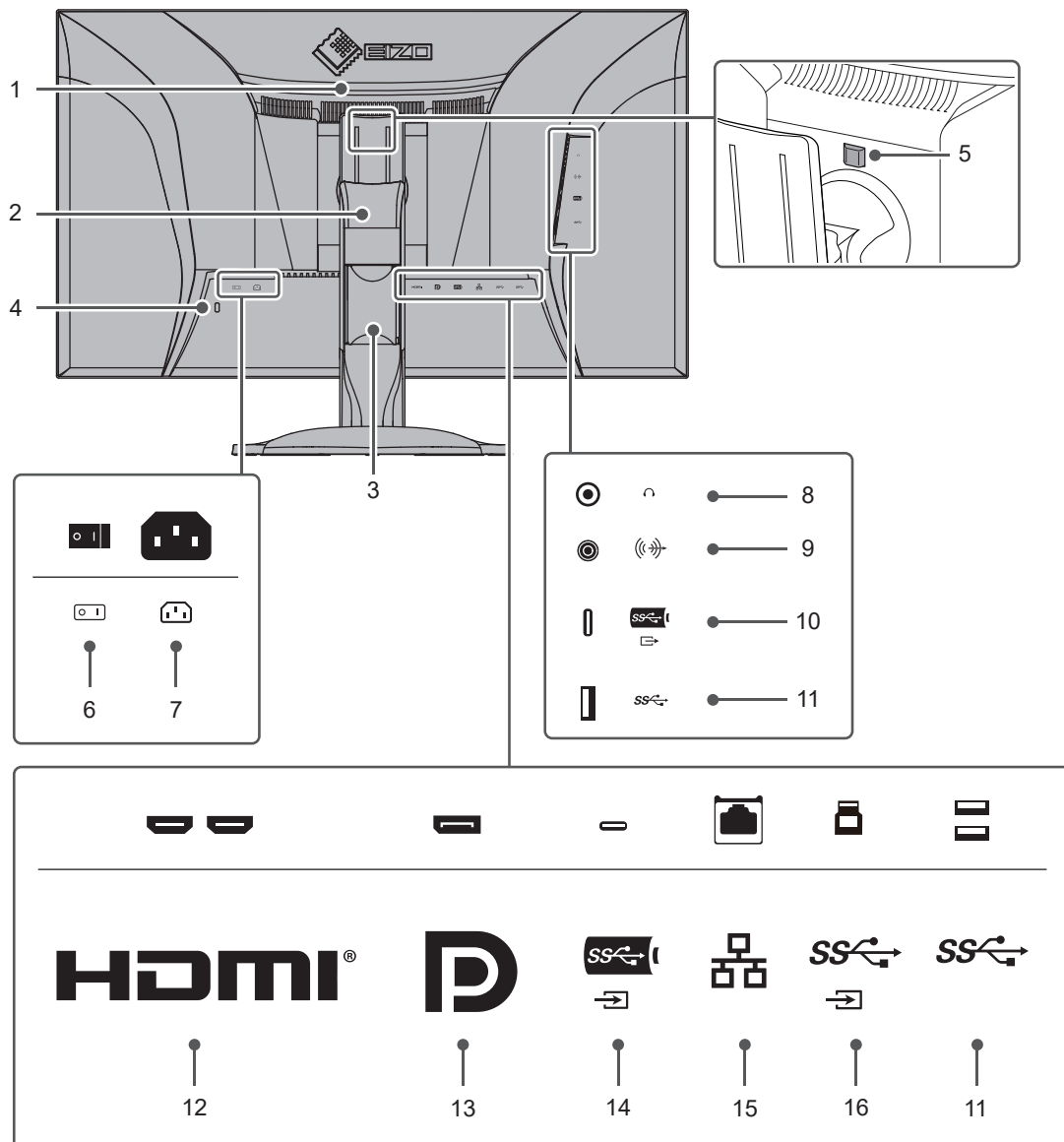

1. Handle	This handle is used for transportation.
2. Stand¹	Adjusts the height and angle (tilt and swivel) of the monitor. The monitor can also be rotated vertically.
3. Cable holder	Holds the monitor cables.
4. Security lock slot	Complies with Kensington's MicroSaver security system.
5. Lock button	Use this button to remove the monitor from the stand.
6. Main power switch	Turns the main power on or off. : On, ○ : Off
7. Power connector	Connects the power cord.
8. Headphone jack	Connects to headphones.
9. Stereo mini jack	External speakers can be connected to output sound from the connected speakers.
10. USB-C connector (downstream)	Connects to a peripheral USB device (see 8.1 Using the Docking Station Function [▶ 47]).

11. USB-A connector (downstream)	
12. HDMI connector	Connects to a PC with HDMI output.
13. DisplayPort connector	Connects to a PC with DisplayPort output.
14. USB-C connector (upstream)	Connects to a PC with USB-C output. This also transmits the USB signal that is necessary for using software that requires a USB connection or the docking station function (see 8.1 Using the Docking Station Function [▶ 47]).
15. LAN port	Connects to a network hub or router with a LAN cable in order to use the network connection of the docking station function (see 8.1 Using the Docking Station Function [▶ 47]).
16. USB-B connector (upstream)	Connect using USB cable when using software that requires a USB connection.

*1 An optional arm (or optional stand) can be attached by removing the stand section.

1.3 Supported Resolutions

The monitor supports the following resolutions:

PbyP display

Layout 1

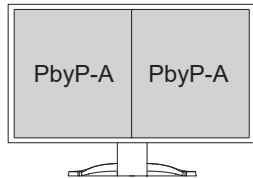

Layout 2

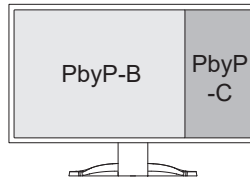

Layout 3

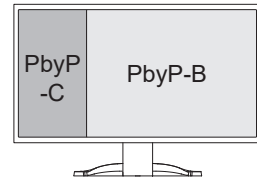

PinP display

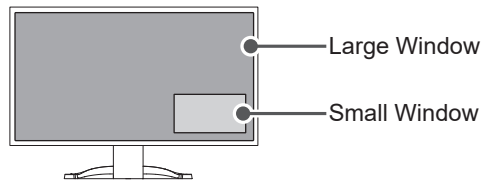

✓: Supported, -: Not supported

Resolution	Vertical scan frequency (Hz)	DisplayPort / USB-C				HDMI			
		Single window display / PinP display	PbyP display			Single window display / PinP display	PbyP display		
			PbyP-A	PbyP-B	PbyP-C		PbyP-A	PbyP-B	PbyP-C
640 x 480	59.940	✓	✓	✓	✓	✓	✓	✓	✓
640 x 480	60.000	✓	✓	✓	✓	✓	✓	✓	✓
720 x 400	70.087	✓	✓	✓	✓	✓	✓	✓	✓
720 x 480	59.940	✓	✓	✓	✓	✓	✓	✓	✓
720 x 480	59.941	✓	✓	✓	✓	✓	✓	✓	✓
720 x 480	60.000	✓	✓	✓	✓	✓	✓	✓	✓
720 x 576	50.000	-	-	-	-	✓	✓	✓	✓
800 x 600	60.317	✓	✓	✓	✓	✓	✓	✓	✓
1024 x 768	60.004	✓	✓	✓	✓	✓	✓	✓	✓
1280 x 720	50.000	-	-	-	-	✓	✓	✓	✓
1280 x 720	59.855	✓	✓	✓	✓	✓	✓	✓	✓
1280 x 720	59.940	✓	✓	✓	✓	✓	✓	✓	✓
1280 x 720	59.979	✓	✓	✓	✓	✓	✓	✓	✓
1280 x 720	60.000	✓	✓	✓	✓	✓	✓	✓	✓
1280 x 800	59.810	✓	✓	✓	✓	✓	✓	✓	✓
1280 x 800	59.910	✓	✓	✓	✓	✓	✓	✓	✓
1280 x 1024	60.020	✓	✓	✓	✓	✓	✓	✓	✓
1280 x 1600	59.910	-	✓	-	-	-	✓	-	-
1280 x 2160	29.952	-	-	-	-	-	-	-	✓
1280 x 2160	59.928	-	-	-	✓	-	-	-	✓
1600 x 900	60.000	✓	✓	✓	✓	✓	✓	✓	✓
1600 x 1200	60.000	✓	✓	✓	✓	✓	✓	✓	✓
1680 x 1050	59.883	✓	✓	✓	✓	✓	✓	✓	✓

Resolution	Vertical scan frequency (Hz)	DisplayPort / USB-C				HDMI			
		Single window display / PinP display	PbyP display			Single window display / PinP display	PbyP display		
			PbyP-A	PbyP-B	PbyP-C		PbyP-A	PbyP-B	PbyP-C
1680 x 1050	59.954	✓	✓	✓	✓	✓	✓	✓	✓
1920 x 1080	29.970	✓	✓	✓	✓	✓	✓	✓	✓
1920 x 1080	30.000	✓	✓	✓	✓	✓	✓	✓	✓
1920 x 1080	50.000	-	-	-	-	✓	✓	✓	✓
1920 x 1080	59.940	✓	✓	✓	✓	✓	✓	✓	✓
1920 x 1080	60.000	✓	✓	✓	✓	✓	✓	✓	✓
1920 x 1200	59.885	✓	✓	✓	✓	✓	✓	✓	✓
1920 x 1200	59.950	✓	✓	✓	✓	✓	✓	✓	✓
1920 x 2160	29.952	-	-	-	-	-	✓	-	-
1920 x 2160	59.988	-	✓	-	-	-	✓	-	-
2560 x 1440	59.951	✓	-	✓	-	✓	-	✓	-
2560 x 2160	29.994	-	-	✓ ^{*2}	-	-	-	✓	-
2560 x 2160	59.978	-	-	✓	-	-	-	✓	-
3840 x 2160	29.970	-	-	-	-	✓	-	-	-
3840 x 2160	29.981	✓	-	-	-	✓	-	-	-
3840 x 2160	30.000	-	-	-	-	✓	-	-	-
3840 x 2160	50.000	-	-	-	-	✓	-	-	-
3840 x 2160 ^{*1}	59.940	-	-	-	-	✓	-	-	-
3840 x 2160 ^{*1}	59.997	✓	-	-	-	✓	-	-	-
3840 x 2160	60.000	-	-	-	-	✓	-	-	-

*1 Recommended resolution

*2 DisplayPort is not supported

Note

- Only progressive is supported for the Scan Format.

2 Basic Adjustment/Setting

This product enables users to change the brightness according to personal preference or to suit the usage environment, and to reduce power consumption to conserve energy.

For advanced adjustment and setting procedures using the Setting menu, see [3 Advanced Adjustments/Settings](#) [▶ 19].



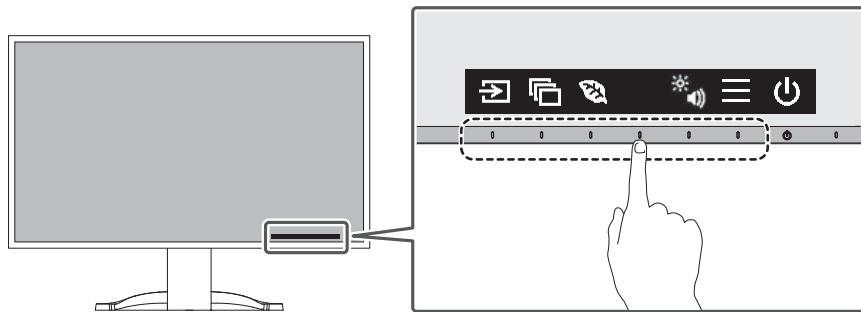

2.1 Switch Operation Method

1. Touch any switch (except )
The operation guide appears on the screen.



Note

- Do not directly touch the operation guide that appears on the screen. There are switches below the operation guide that can be touched to perform adjustment/setting.

2. Touch a switch for adjustment/setting.
The adjustment/setting menu appears.
(A sub menu may also be displayed. In this case, select the item for adjustment/setting using   and select .)
3. Perform adjustment/setting with the switches and select  to accept the changes.
4. Select  to exit the menu.

2.2 Switching Input Signals

When a monitor has multiple signal inputs, the signal to display on-screen can be changed.

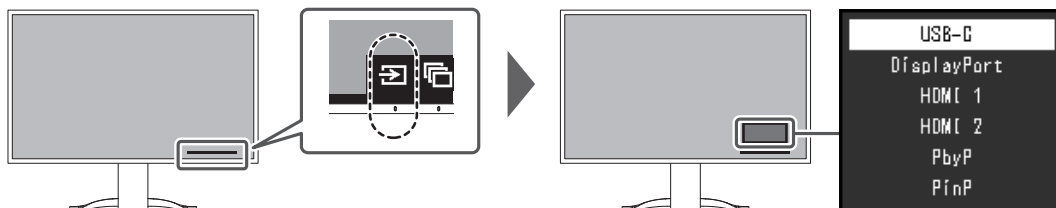

To switch to "PbyP" or "PinP", select "PbyP" or "PinP" and select .

For information on PbyP, see [4.2 Using PbyP Display](#) [▶ 30].

For information on PinP, see [4.3 Using PinP Display](#) [▶ 31].

Note

- "Screen InStyle" allows you to switch input signals using the shortcut keys on the keyboard.

2.3 Switching Display Modes (Color Modes)

This product is preinstalled with color modes for various display purposes.

By switching the color mode according to the purpose and contents of the display, you can display images in an appropriate manner.



2.3.1 Color Modes

Color Mode	Purpose
User 1 / User 2	Select either of these modes to set a user-defined display mode.
sRGB	This mode is suitable for matching color reproduction with peripheral devices that support sRGB, such as when printing photos taken using a digital camera.
Paper	This mode uses color tones and contrast similar to that of paper to produce a printed paper effect. It is suitable for displaying images from media such as books and documents.
Movie	This mode displays moving images brightly and with a clear-cut three-dimensional appearance. It is suitable for playing back video content.
DICOM	Select this mode to simply display digital imaging for medical based on DICOM® Part 14. "EcoView Settings" and "Color" become invalid, and cannot be adjusted or set. Note <ul style="list-style-type: none"> This is not intended to be used for diagnostic purposes.

Note
<ul style="list-style-type: none"> "Screen InStyle" allows you to select the color mode automatically according to the software in use. In Paper mode, the amount of blue light emitted from the screen is reduced by changing the color tone and controlling the brightness.

2.4 Conserving Energy

This monitor is equipped with EcoView functions to enable users to conserve energy.

If you use Auto EcoView, which is one of the EcoView functions, the screen brightness is automatically adjusted according to the ambient brightness.

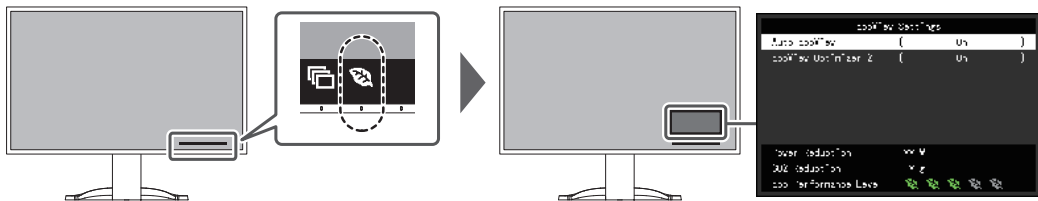

Note

- The power saving level (Power Reduction, CO₂ Reduction, and Eco Performance Level) can be checked on the "EcoView Settings" menu. The more indicators that light up representing the Eco Performance Level, the higher the power saving level attained.
 - Power Reduction: the reduction in the backlight's power consumption as a result of the adjusted brightness value.
 - CO₂ Reduction: converted from the "Power Reduction" value, this is an estimate of the quantity of CO₂ emissions reduced when using the monitor for one hour.
- The figures are calculated based on the Emission factors by electric power company (FY2020 results) - TEPCO Energy Partner "Menu J (residual)" published by the Ministry of the Environment of Japan.

Auto EcoView

Settings: "On" / "Off"

The ambient light sensor on the front of the monitor detects the ambient brightness to automatically adjust the screen brightness to a comfortable level using Auto EcoView.

The power consumption of the backlight can be curtailed by adjusting the brightness to an appropriate level.

This function can also mitigate eye strain and tiredness caused by a screen that is too bright or too dark.

Note

- Be careful not to block the ambient light sensor on the lower side of the monitor when using Auto EcoView.
- Even when Auto EcoView is set to "On", you can change the brightness of the monitor using the operation switches () on the front of the monitor or in the color adjustment settings. The manner in which Auto EcoView changes the brightness will also vary depending on the value you set.
- When "DICOM" is selected for the color mode, the Auto EcoView setting is turned "Off".

EcoView Optimizer 2

Settings: "On" / "Off"

The monitor automatically adjusts the screen brightness according to the white level of the input signal.

This function can reduce power consumption while maintaining the brightness specified by the input signal.

Note

- The EcoView Optimizer 2 setting becomes "Off" in the following cases:
 - When "Movie" or "DICOM" is selected for the color mode
 - When using PbyP/PinP display
- When set to "On", the appearance of pale colors may change. If this bothers you, set this function to "Off".

2.5 Adjusting Brightness

Settings: "0" to "100"

The brightness of the screen can be adjusted to suit the installation environment or personal preference.

The screen brightness is adjusted by changing the brightness of the backlight (light source from the LCD back panel).

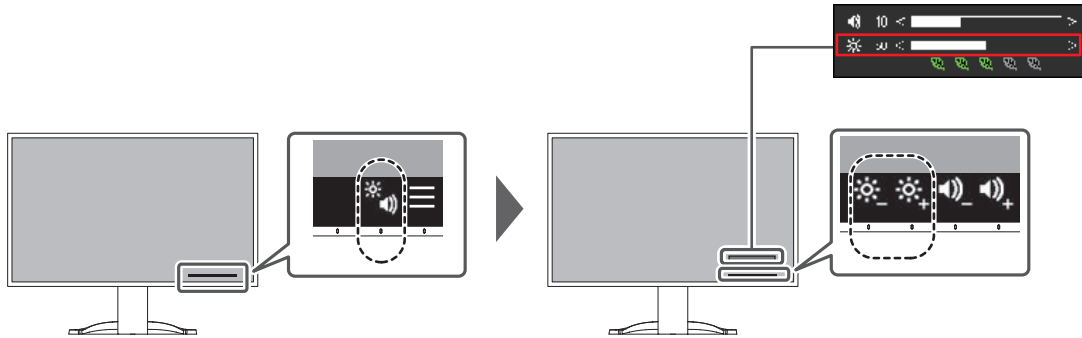

2.6 Adjusting Volume

Settings: "0" to "30"

The volume of the speakers and headphones can be set individually.

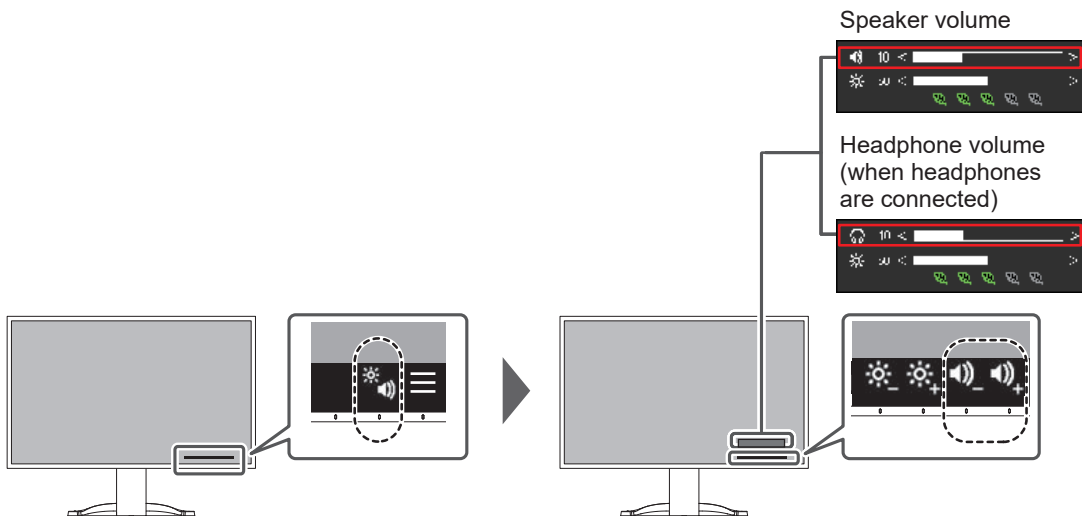



3 Advanced Adjustments/Settings



This chapter describes the advanced monitor adjustment and setting procedures using the Setting menu.

For basic functions, see [2 Basic Adjustment/Setting \[▶ 15\]](#).

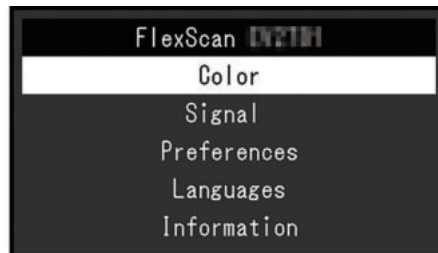

3.1 Basic Operation of the Setting Menu

1. Touch any switch (except )
The operation guide appears.
2. Select 
The Setting menu appears.









3. Select a menu to adjust/set with   and select 
The Sub menu appears.



4. Select a menu to adjust/set with   and select 
The adjustment/setting menu appears.



5. Perform adjustment/setting with   or   and select  to accept the changes.
The Sub menu appears.
Selecting  during adjustment/setting will cancel the adjustment/setting and restore the state prior to making changes.
6. Selecting  several times will terminate the Setting menu.

3.2 Setting Menu Functions

3.2.1 Color

The color mode settings can be adjusted according to personal preference. The adjusted settings are saved for each color mode.



Functions that can be adjusted differ depending on the color mode.

✓: Adjustable, -: Not adjustable

Function		Color Mode				
		User1 User2	sRGB	Paper	Movie	DICOM
Brightness		✓	✓	✓	✓	-
Contrast		✓	-	-	✓	-
Temperature		✓	-	✓	✓	-
Gamma		✓	-	-	-	-
Advanced Settings	Overdrive	✓	-	-	-	-
	Hue	✓	-	-	✓	-
	Saturation	✓	-	-	✓	-
	Gain	✓	-	-	-	-
Reset		✓	✓	✓	✓	-

Attention

- It takes about 30 minutes for the monitor display to stabilize. Please wait 30 minutes or more after power to the monitor has been turned on before adjusting the monitor.
- The same image may be observed in different colors on multiple monitors due to monitor-specific characteristics. Make fine color adjustments visually when matching colors across multiple monitors. Follow the procedure below to adjust and match colors across multiple monitors.
 1. Display a white screen on each monitor.
 2. Use one of the monitors as a visual reference point to make adjustments to "Brightness", "Temperature", and "Gain" on the other monitors.
- When Auto EcoView is set to "On", the same brightness setting is shared by all of the color modes and cannot be set individually for each color mode.

Color Mode

Settings: "User1" / "User2" / "sRGB" / "Paper" / "Movie" / "DICOM"

Select the desired mode according to the monitor application.

The color mode settings can also be adjusted according to personal preference. Select the color mode for adjustment and perform adjustment using the relevant functions.

Note

- For details on the adjustment status of each color mode, see [2.3 Switching Display Modes \(Color Modes\)](#) [▶ 16].

Brightness

Settings: "0" – "100"

The screen brightness is adjusted by changing the brightness of the backlight (light source from the LCD back panel).

Note

- If the image is too dark even when the brightness is set to 100, adjust the contrast.

Contrast

Settings: "0" – "100"

The brightness of the screen is adjusted by varying the video signal level.

Note

- A contrast of 50 displays every color gradation.
- When adjusting the monitor, it is recommended to perform brightness adjustment, which does not lose gradation characteristics, prior to contrast adjustment.
- Perform contrast adjustment in the following cases:
 - If the image is too dark even when the brightness is set to 100 (Set the contrast to higher than 50.)

Temperature

Settings: "Off" / "4000 K" – "10000 K" (in increments of 500 K. 9300 K is included.)

Adjusts the color temperature.

The color temperature is normally used to express the hue of "White" and/or "Black" with a numerical value. The value is expressed in degrees "K" (Kelvin).

The screen becomes reddish at low color temperatures and bluish at high color temperatures, similar to the temperatures of a flame. A gain preset value is set for each color temperature setting value.

Note

- The value shown in "K" is available only as a reference.
- "Gain" allows you to perform more advanced adjustment.
- If set to "Off", the image is displayed in the preset color of the LCD panel (Gain: 100 for each RGB channel).
- When the gain is changed, the color temperature setting changes to "Off".

Gamma

Settings: "1.8" / "2.0" / "2.2" / "2.4"

Adjusts the gamma.

While the brightness of the monitor varies depending on the video level of the input signal, the variation rate is not directly proportional to the input signal. Maintaining the balance between the input signal and brightness of the monitor is referred to as "Gamma correction".

Note

- If "Paper" is selected for the color mode, "Paper" is displayed for the gamma value.
- If "DICOM" is selected for the color mode, "DICOM" is displayed for the gamma value.

Advanced Settings - Overdrive

Settings: "Enhanced" / "Standard" / "Off"

This function allows you to set the overdrive intensity based on the use of the monitor. Image lag can be reduced by using the "Enhanced" setting when displaying moving images.

Note

- Depending on the display resolution and the setting of [Picture Expansion \[▶ 23\]](#), overdrive may be set to "Off".

Advanced Settings - Hue

Settings: "-50" – "50"

Adjusts the hue.

Note

- Using this function may prevent some color gradations from being able to be displayed.

Advanced Settings - Saturation

Settings: "-50" – "50"

Adjusts the color saturation.

Note

- Using this function may prevent some color gradations from being able to be displayed.
- The minimum value (-50) changes the screen to monochrome.

Advanced Settings - Gain

Settings: "0" – "100"

The brightness of each red, green, and blue color component is referred to as "Gain". The hue of "white" can be changed by adjusting the gain.

Note

- Using this function may prevent some color gradations from being able to be displayed.
- The gain value changes according to the color temperature.
- When the gain is changed, the color temperature setting changes to "Off".

Reset

Resets any color adjustments for the currently selected color mode back to the default settings.

3.2.2 Signal

Set the details regarding input signal, such as the screen size and color format.



Window Selection

Settings: "Left" / "Right" / "Large Window" / "Small Window"

Select the screen to apply "Signal" to when using PbyP/PinP display.

Please perform this selection when starting usage of PbyP/PinP display.

- "Left"
Applies settings to the left screen of PbyP display.
- "Right"
Applies settings to the right screen of PbyP display.
- "Large Window"
Applies settings to the large window of PinP display.
- "Small Window"
Applies settings to the small window of PinP display.

Note

- This can only be set when using PbyP/PinP display.
- For information on PbyP, see [4.2 Using PbyP Display \[▶ 30\]](#).
- For information on PinP, see [4.3 Using PinP Display \[▶ 31\]](#).

Picture Expansion

Settings: "Auto"^{*1} / "Full Screen" / "Aspect Ratio" / "Dot by Dot"

^{*1} Only enabled during HDMI input

The screen size of the monitor display can be changed.

- "Auto"
The monitor automatically changes the screen size according to the aspect ratio and resolution information from the PC.
- "Full Screen"
Displays images in full screen. Since aspect ratios are not maintained, images may be distorted in some cases.
- "Aspect Ratio"
Images are enlarged to full screen without changing the aspect ratio. Since aspect ratios are maintained, blank horizontal or vertical borders may appear.
- "Dot by Dot"
Displays the image at the set resolution or at the size specified by the input signal.

Note

- Setting example

Full-screen

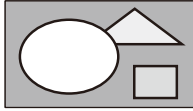

Fixed aspect ratio

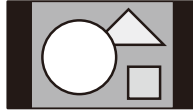

Actual size (input signal)



- During PinP display, the small window is displayed in a fixed aspect ratio and the display size of the window cannot be changed.

Sharpness

Settings: "-2" – "2"

When a low-resolution image is displayed using picture expansion mode ("Full Screen" or "Aspect Ratio"), the text and lines of the image may appear blurry. This blurriness can be reduced by configuring the settings for sharpness.

Note

- For some display resolutions, it is not necessary to configure the settings for sharpness. ("Sharpness" is not a value that can be selected.)

Input Color Format

Settings: "Auto" / "YUV 4:2:2^{*1}" / "YUV 4:4:4^{*1}" / "YUV^{*2}" / "RGB"

The color format of the input signal can be specified.

Try changing this setting if colors are not displayed correctly.

*1 Only enabled during HDMI input

*2 Only valid for DisplayPort or USB-C input

Input Range

Settings: "Auto" / "Full" / "Limited"

Depending on the video reproduction device, there may be a restriction on black and white video signal levels output to the monitor. This kind of signal is called "Limited range". On the other hand, unlimited signals are called "Full range".

- "Auto"

Input signal brightness range is automatically judged and is displayed appropriately (recommended setting). Depending on the video reproduction device, Limited range and Full range may not be able to be judged by the monitor. In such a case, selecting "Full" or "Limited" will allow it to be displayed appropriately.
- "Full"

To be selected in case of Full range signals. Appropriate display can be obtained when this is selected, in case both blacks and whites are corrupted.
- "Limited"

To be selected in case of Limited range signals. In case this is selected, the output signal range is expanded from 0 to 255 to obtain an appropriate display when black is pale and white is dull.

Note

- When "YUV" is selected in "Input Color Format", the setting is automatically set to "Limited". Additionally, when "Auto" is selected and the monitor determines the input color format to be YUV, the setting is automatically set to "Limited".

3.2.3 Preferences

The monitor's settings can be configured to suit the usage environment or personal preference.

**Menu Rotation**

Settings: "0°" / "90°"

When the monitor is used in a portrait position, the direction of the Setting menu can also be changed.

Note

- Check whether the cables are connected properly.
- It is necessary to configure the settings of the PC to use the monitor in a portrait position. For details, refer to our web site (www.eizoglobal.com).
- The menu cannot be rotated 180°. When rotating a monitor 180°, perform the adjustments/settings for the monitor before rotating it.

Power Save

Settings: "On" / "Off"

The monitor can be set to enter power saving mode according to the state of the PC.

The monitor changes to power saving mode about 15 seconds after signal input ceases to be detected.

When the monitor has shifted to power saving mode, images are not displayed on the screen and audio is not output.

- How to exit power saving mode
 - Press the operation switches (excluding ) on the front of the monitor
 - The monitor automatically exits power saving mode when the monitor receives input

Note

- At the time of shifting to power saving mode, a message that indicates the transition is displayed five seconds in advance.
- When using PbyP/PinP display, the monitor will revert to power saving mode only when both PCs are in power saving mode.
- When not using the monitor, you can turn off the main power supply or disconnect the power plug so that the power is cut completely.
- When [Compatibility Mode \[▶ 35\]](#) is set to "On", even if the monitor shifts to power saving mode, devices connected to the USB downstream port are operational. Therefore, power consumption of the monitor varies with connected devices even in power saving mode.

Power Indicator

Settings: "On" / "Off"

The power indicator (white) can be turned off in normal operation mode.

USB Selection - DisplayPort / HDMI 1 / HDMI 2

Settings: "USB-C" / "USB-B"

When two PCs are connected to one monitor, you can link the input signal with the USB upstream port. For details, see [4.4 Linking the Input Signal and USB Port \[▶ 32\]](#).

The compatibility of setting values and USB connectors is as follows.

"USB-C": USB-C connector (upstream) 

"USB-B": USB-B connector (upstream) 

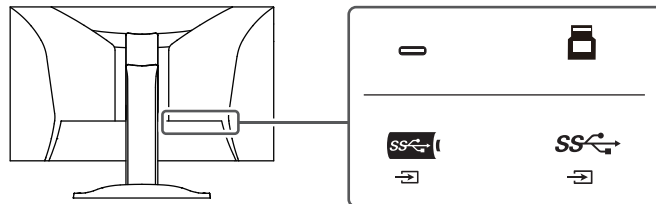
**Note**

- In the default settings, "USB-B" is set for all input signals. Change the settings so that they do not overlap.
- Before changing the setting, remove all connected USB memory devices from the monitor. Otherwise, data may be lost or damaged.
- The keyboard layout cannot be changed.

Sound Selection (PbyP/PinP)

Settings: "Left" / "Right" / "Large Window" / "Small Window"

Select the audio to be output from the monitor during PbyP/PinP display.

- "Left"
Outputs audio of the left screen of PbyP display.
- "Right"
Outputs audio of the right screen of PbyP display.
- "Large Window"
Outputs audio of the large window of PinP display.

- "Small Window"
Outputs audio of the small window of PinP display.

Note

- This can only be set when using PbyP/PinP display.
- For information on PbyP, see [4.2 Using PbyP Display \[▶ 30\]](#).
- For information on PinP, see [4.3 Using PinP Display \[▶ 31\]](#).

Monitor Reset

Restores all settings to their default settings except for the following settings:

- PbyP/PinP display settings
- Settings on the "Administrator Settings" menu

3.2.4 Languages

Settings: "English" / "German" / "French" / "Spanish" / "Italian" / "Swedish" / "Japanese" / "Simplified Chinese" / "Traditional Chinese"

The display language for menus and messages can be selected.

**Attention**

- The display language of the "Administrator Settings" menu (English) cannot be changed.

3.2.5 Information

You can check the monitor information (model name, serial number (S/N), firmware version, usage time) and the input signal information.

Example:

- Single window display

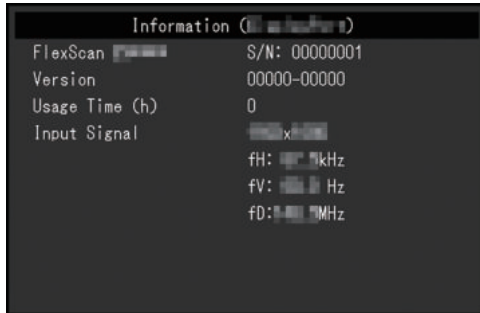

- PbyP display

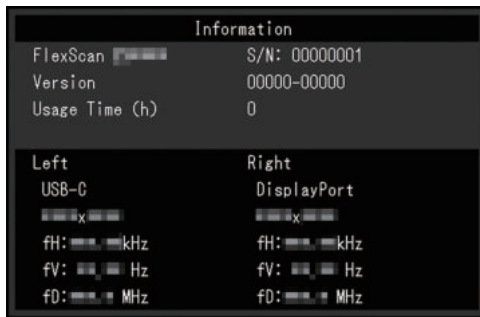

- PinP display

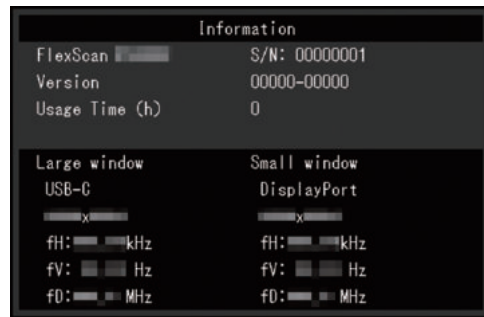

When  is selected, the certification standard logo appears on the screen.



4 Connecting Multiple PCs

4.1 Connecting Multiple PCs

This product can be connected to multiple PCs and allows you to switch between the connections for display.

Connection Examples

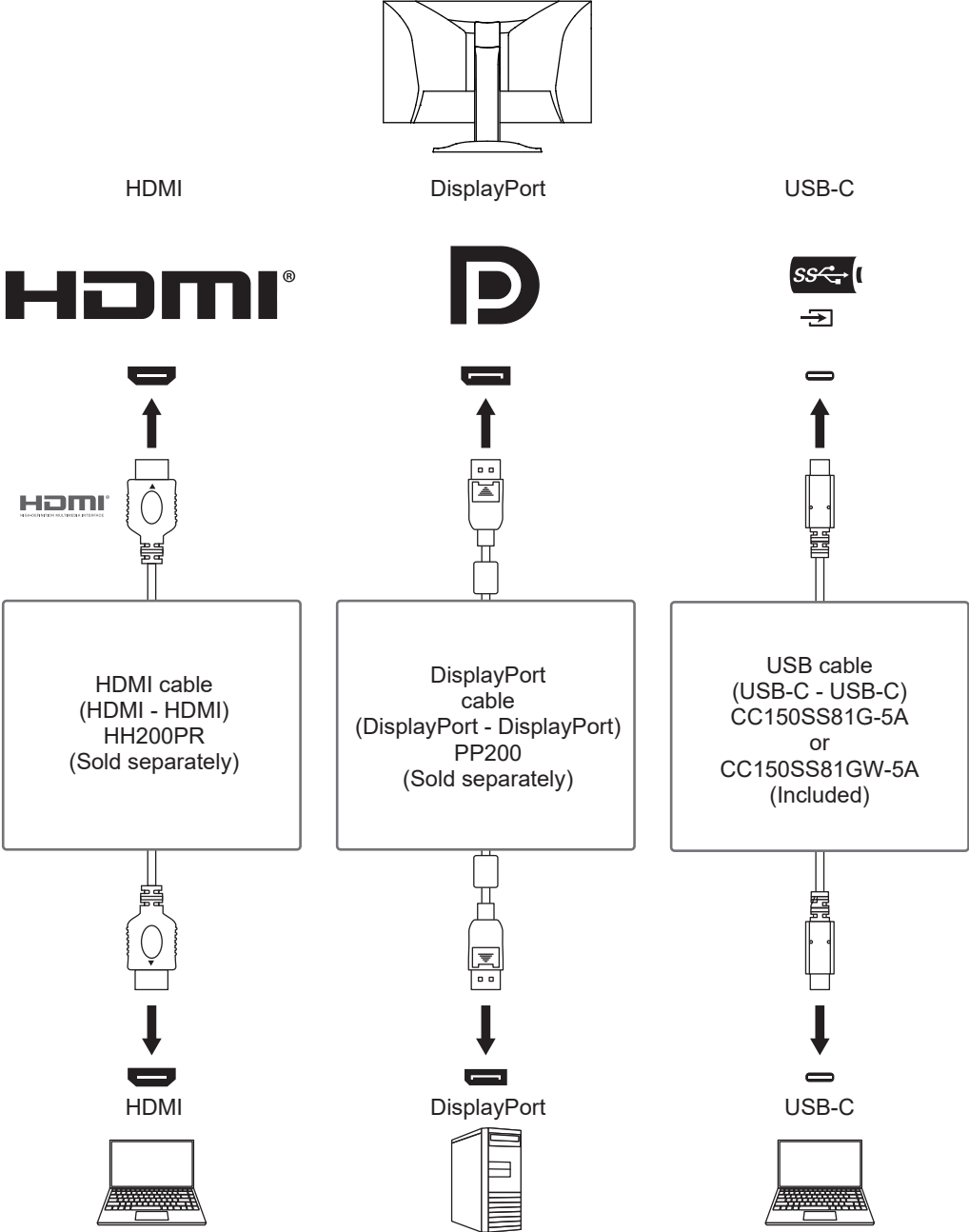

Note

- You can select the input signal to display using the operation switch () on the front of the monitor. For details, see [2.2 Switching Input Signals \[▶ 15\]](#).
- This product provides a function that automatically recognizes the connector through which PC signals are input, and displays images on the screen accordingly. For details, see [Auto Input Detection \[▶ 35\]](#).

4.2 Using PbyP Display

If you select PbyP display and input multiple signals to the monitor, you can display multiple windows side-by-side. Two screens can be displayed on one screen, so switching signals is no longer necessary and work productivity improves. The combination of signals can also be changed.

PbyP Settings

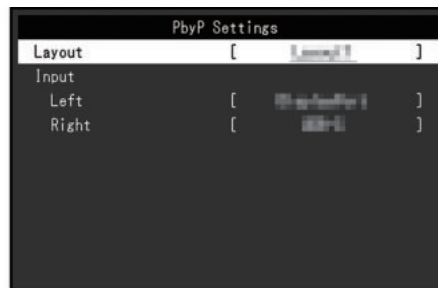

Layout 1

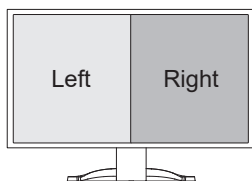

Layout 2

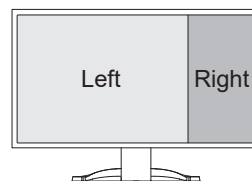

Layout 3

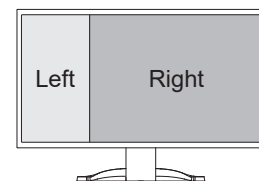

Layout

Settings: "Layout 1" / "Layout 2" / "Layout 3"

Selects the layout.

Input - Left

Settings: "USB-C" / "DisplayPort" / "HDMI 1" / "HDMI 2"

Selects the input signal for each screen.

Note

The same input signal cannot be set for the left and right screens. When changing the input signal on one of the screens, selecting an input signal already set on another screen will automatically switch the signal.

Input - Right

Settings: "USB-C" / "DisplayPort" / "HDMI 1" / "HDMI 2"

Selects the input signal for each screen.

4.3 Using PinP Display

If you select PinP display and input multiple signals to the monitor, you can display them in the large window and small window. Multiple screens can be displayed on one screen, so switching signals is no longer necessary and work productivity improves. The signal combination of the large window and small window can be switched.

PinP Settings

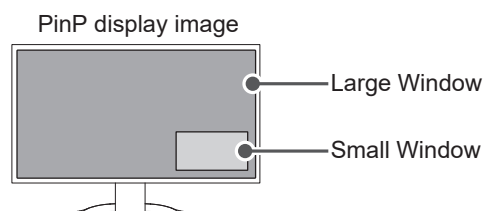
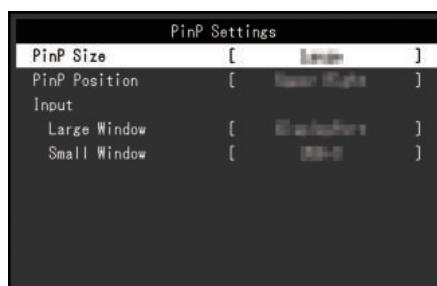

PinP Size

Settings: "Large" / "Small"

Select the size of the small window.

PinP Position

Settings: "Upper Left" / "Lower Left" / "Upper Right" / "Lower Right"

Select the display position of the small window.

Input - Large Window

Settings: "USB-C" / "DisplayPort" / "HDMI 1" / "HDMI 2"

Selects the input signal for the large window.

Note

The same input signal cannot be set for the large window and small window. For this reason, when changing the input signal of the large window, selecting an input signal already set on the small window will automatically switch the signal between the large window and small window.

Input - Small Window

Settings: "USB-C" / "DisplayPort" / "HDMI 1" / "HDMI 2"

Selects the input signal for the small window.

4.4 Linking the Input Signal and USB Port

When two PCs are connected to one monitor, you can link the input signal with the USB upstream port. This makes it possible to connect USB devices such as a mouse or keyboard to the monitor and use them from multiple PCs.

Connection Examples

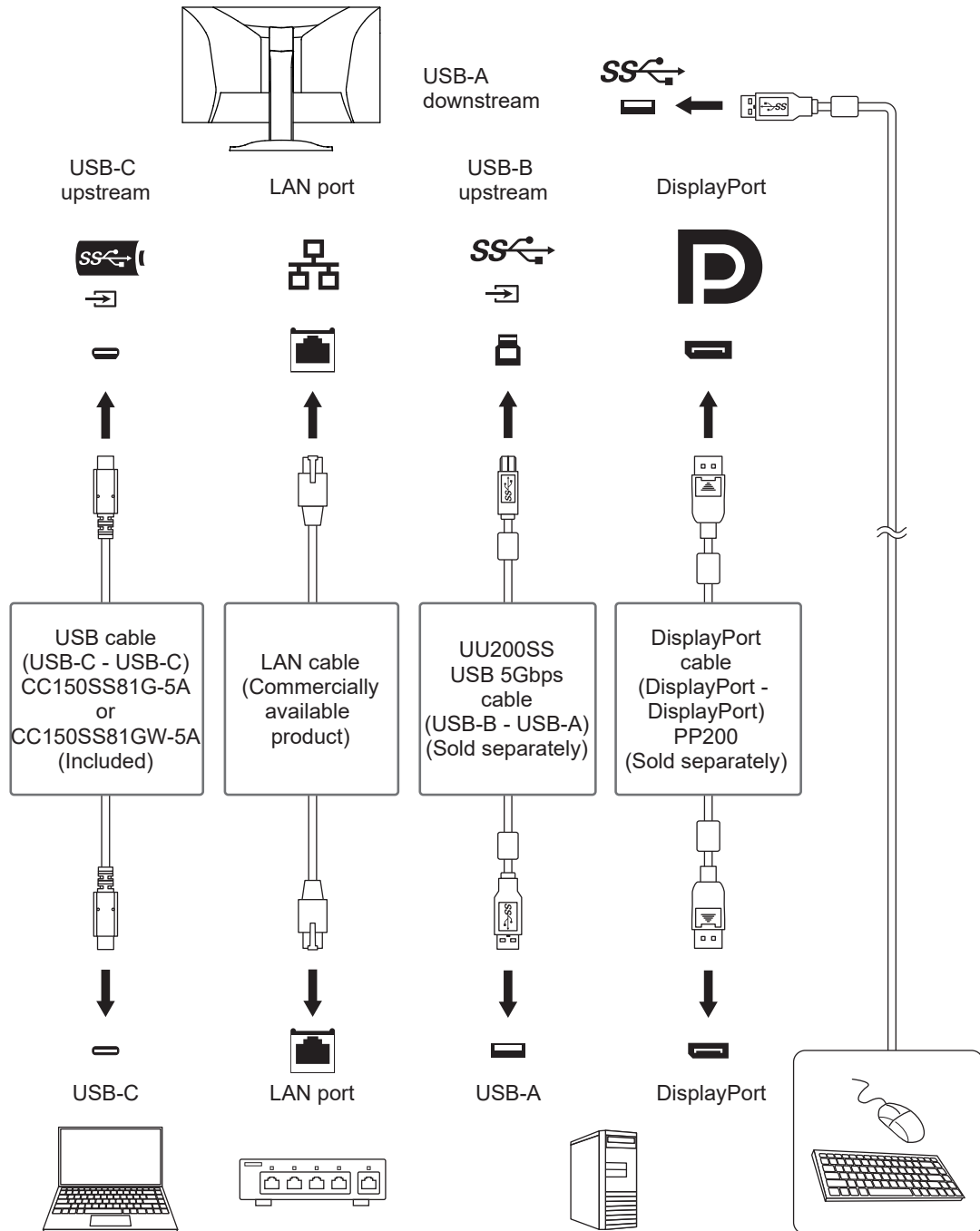

4.4.1 Linking

See [USB Selection - DisplayPort / HDMI 1 / HDMI 2](#) [▶ 26] to link the USB upstream port to the input signal.

4.4.2 Switching USB Ports

Use either of the following methods to switch the USB upstream port.

Changing the input signal

The USB upstream port switches automatically.

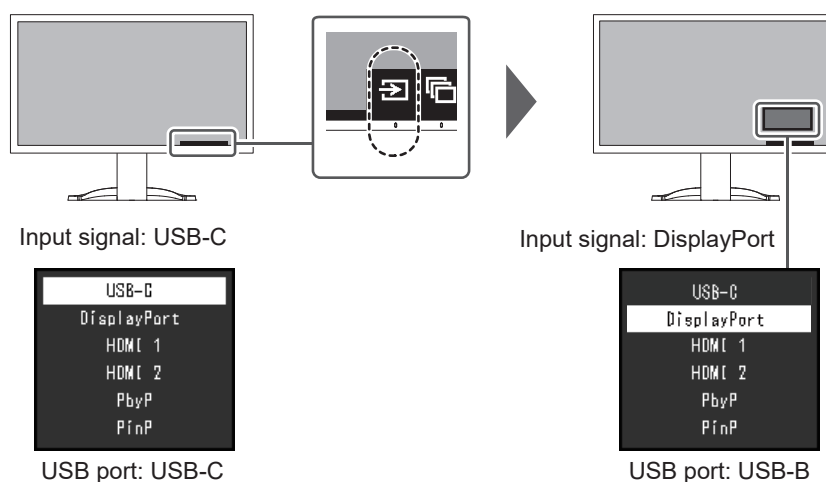

Using the operation switch () on the front of the monitor to switch ports (when using PbyP/PinP display)

When you touch the operation switch (), a frame is displayed around one screen. The USB port linked to the signal for this screen is enabled.

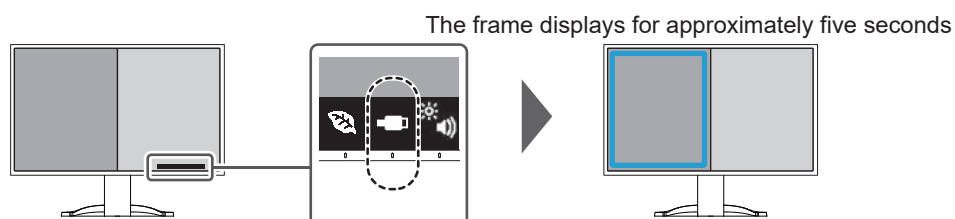

Each time you touch the operation switch (), the frame moves.

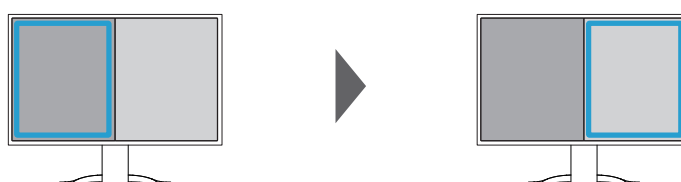



Note

- When using both USB-C and USB-B connections, switching the input signal or USB upstream port will temporarily disconnect the USB signal. If a storage device such as a USB memory stick is connected to the monitor, switch the port only after you have removed the storage device.

5 Administrator Settings

This chapter describes how to configure monitor operation using the "Administrator Settings" menu.

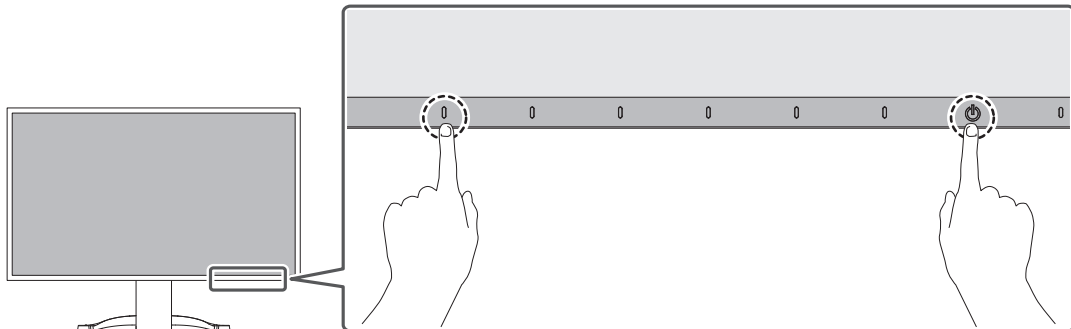

5.1 Basic Operation of the "Administrator Settings" Menu

1. Touch  to turn off the monitor.
2. While touching the leftmost switch, touch  for more than two seconds to turn on the monitor.



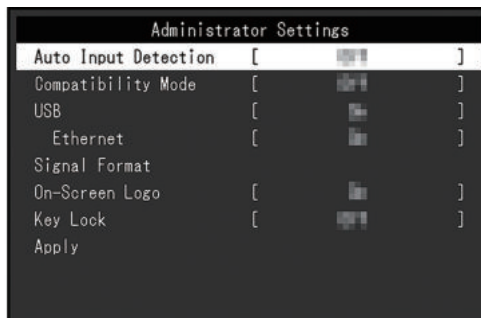



The "Administrator Settings" menu appears.

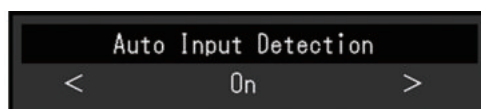

3. Select an item to set with   and select .
- The adjustment/setting menu appears.



4. Set with   and select .
 5. Select "Apply" and then .
- The settings are applied and the "Administrator Settings" menu exits.

Attention

- The language (English) of the "Administrator Settings" menu cannot be changed.

5.2 Functions of the "Administrator Settings" Menu

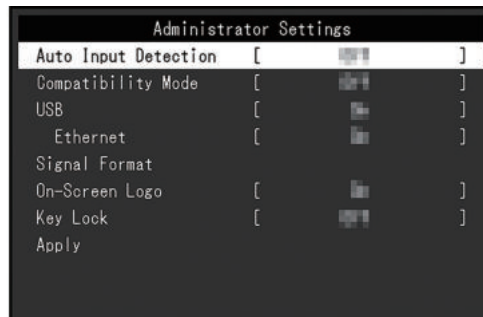

Auto Input Detection

Settings: "On" / "Off"

This function automatically recognizes the connector through which PC signals are input, and displays images on the screen accordingly.

- "On"

When the monitor is connected to multiple PCs, if a specific PC enters power saving mode or no signals are input to the monitor, the connector is automatically changed to another one to which signals are input.
- "Off"

To be set to this when manually selecting input signals. Select the input signal to display using the operation switch () on the front of the monitor. For details, see [2.2 Switching Input Signals \[▶ 15\]](#).

Note

- Does not function in PbyP/PinP display.
- This product automatically recognizes the connector through which PC signals are input, and displays images on the screen accordingly regardless of whether this function is set to On or Off just after the main power switch on the back of the monitor has been turned on.
- When this function is set to "On", the monitor only enters the power saving mode when signals are not input from any PC.

Compatibility Mode

Settings: "On" / "Off"

If you want to avoid the following phenomena, set this function to "On":

- The positions of windows and icons are shifted when the monitor is turned off/on or has returned from the power saving mode.
- Even when the mouse or keyboard are used, the PC does not return from sleep.
- When the power to the monitor is turned off, a device connected to the USB downstream port does not work, or power is not supplied to the connected device.
- When the power to the monitor is turned off, power is not supplied to devices connected to the USB-C connector.

USB

Settings: "On" / "Off"

You can switch between enabling and disabling of the USB port of the monitor.

- "On"

Enables the USB port. If you are using the following functions, set this function to "On":

- Display of video signals using USB-C
- Docking Station Function
- USB Power Delivery
- Screen InStyle (monitor control)
- "Off"
Disables the USB port so that USB peripheral devices cannot be used.

Note

- By pressing the switch on the far left for three seconds or more when the device's power is on and when the Setting menu/Button Guide are not displayed, you can make the setting "On" (It cannot be made "Off" at the same time).

Ethernet

Settings: "On" / "Off"

You can switch between enabling and disabling of the LAN port of the monitor.

- "On"
Enables the LAN port and allows network connections from PCs connected with USB-C.
- "Off"
Disables the LAN port.

Note

- When "USB" is set to "Off", this cannot be set.

Signal Format - USB-C

Settings: "HBR3 / USB3.2 Gen1" / "HBR2 / USB2.0"

The type of signal that can be displayed on the monitor can be changed. Try changing this setting if the input signal is not displayed correctly or the intended display does not show.

Note

- The default setting is "HBR3 / USB3.2 Gen1" (maximum USB transfer speed is 5 Gbps). When connecting to a computer that does not support HBR3, set to "HBR2 / USB2.0" (maximum USB transfer speed is 480 Mbps).

Signal Format - DisplayPort

Settings: "Version 1.2" / "Version 1.4"

The type of signal that can be displayed on the monitor can be changed. Try changing this setting if the input signal is not displayed correctly or the intended display does not show.

Signal Format - HDMI 1 / HDMI 2

Settings: "4K UHD 60Hz" / "4K UHD 30Hz"

The type of signal that can be displayed on the monitor can be changed. Try changing this setting if the input signal is not displayed correctly or the intended display does not show.

On-Screen Logo

Settings: "On" / "Off"

When the monitor is turned on, the EIZO logo and certification standard logo appears on the screen.

When this function is set to "Off", the logos do not appear.

Key Lock

Settings: "Off" / "Menu" / "All"

In order to prevent changes to settings, the operation switches on the front of the monitor can be locked.

- "Off" (default setting)
Enables all switches.
- "Menu"
Locks the  switch.
- "All"
Locks all switches except the power switch.

6 Troubleshooting

6.1 No Picture

Power indicator does not light up.

- Check whether the power cord is connected properly.
- Turn on the main power switch on the back of the monitor.
- Touch .
- Turn off the main power switch on the back of the monitor, and then turn it on again a few minutes later.

Power indicator is lighting white.

- Increase "Brightness", "Contrast", or "Gain" in the Setting menu (see [Color \[▶ 20\]](#)).

Power indicator is lighting orange.

- Switch the input signal.
- Turn the setting "On" for "Compatibility Mode" on the "Administrator Settings" menu (see [Compatibility Mode \[▶ 35\]](#)).
- Move the mouse or press any key on the keyboard.
- Check whether the PC is turned on.
- Turn off the main power switch on the back of the monitor, and then turn it on again.

The message "No Signal" appears on the screen

Example:

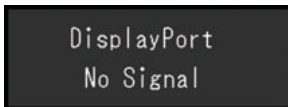

- The message shown above may appear as some PCs do not output the signal immediately after power-on.
- Check whether the PC is turned on.
- Check whether the signal cable is connected properly.
- Switch the input signal.
- Turn off the main power switch on the back of the monitor, and then turn it on again.
- Try setting "Auto Input Detection" in the "Administrator Settings" menu to "Off" and switching the input signal manually (see [Auto Input Detection \[▶ 35\]](#)).

The message "Signal Error" appears on the screen

Example:

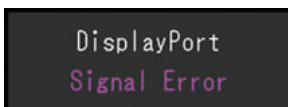

- Check whether the PC is configured to meet the resolution and vertical scan frequency requirements of the monitor (see [1.3 Supported Resolutions \[▶ 13\]](#)).
- Reboot the PC.

- Select an appropriate setting using the graphics board's utility. Refer to the User's Manual of the graphics board for details.

The message "DP Unsupported" appears on the screen

Example:



- Check whether the connected cable is a signal cable recommended by us.
- Check whether the USB-C of the connected device supports video signal output (DisplayPort Alt Mode). For details, contact the manufacturer of the device.
- Connect a DisplayPort cable or an HDMI cable.

The message "No Signal" appears on the screen with a gray background color

Example:



- Check whether "USB" in the "Administrator Settings" menu is set to "On" (see [USB ▶ 35](#)).

6.2 Imaging Problems

The screen is too bright or too dark.

- Use "Brightness" or "Contrast" in the Setting menu to adjust it (see [Color ▶ 20](#)). (The LCD monitor backlight has a limited life span. If the screen becomes dark or begins to flicker, contact your local EIZO representative.)
- If the screen is too bright, try changing the Auto EcoView setting to "On". The monitor detects the ambient brightness to adjust the screen brightness automatically (see [Auto EcoView ▶ 17](#)).

The brightness changes on its own.

- Try changing the Auto EcoView setting to "Off" (see [Auto EcoView ▶ 17](#)).

Characters and images are blurred.

- Check whether the PC is configured to meet the resolution and vertical scan frequency requirements of the monitor (see [1.3 Supported Resolutions ▶ 13](#)). For information on how to change your computer settings, refer to our web site (www.eizoglobal.com).
- Try setting the magnification of display on the OS to "100 %". When using multiple monitors, try setting the magnification of display to "100 %" on all monitors.

Afterimages appear.

- Afterimages are particular to LCD monitors. Avoid displaying the same image for a long time.
- Use the screen saver or power saving function to avoid displaying the same image for extended periods of time.

- An afterimage may appear even after a short time period has elapsed depending on the displayed image. To remove such a phenomenon, change the image or keep the power turned off for several hours.

Green / red / blue / white / dark dots remain on the screen.

- This is due to LCD panel characteristics and not a malfunction.

Interference patterns or pressure marks remain on the LCD panel.

- Leave the monitor with a white or black screen. The symptom may disappear.

Noise appears on the screen.

- In the Setting menu, set "Overdrive" to "Off" (see [Advanced Settings - Overdrive \[▶ 22\]](#)).
- When inputting HDCP system signals, normal images may not be displayed immediately.
- When inputting an HDMI® signal, try changing "Signal Format" in the "Administrator Settings" menu (see [Signal Format - HDMI 1 / HDMI 2 \[▶ 36\]](#)).

The positions of windows and icons are shifted when the monitor is turned off/on or when restored from power saving mode.

- Turn the setting "On" for "Compatibility Mode" on the "Administrator Settings" menu (see [Compatibility Mode \[▶ 35\]](#)).

The color shown on the screen is not correct.

- Try changing "Input Color Format" in the Setting menu (see [Input Color Format \[▶ 24\]](#)).

Images are not displayed over the entire area of the screen.

- Try changing "Picture Expansion" in the Setting menu (see [Picture Expansion \[▶ 23\]](#)).
- When inputting an HDMI signal, try changing "Signal Format" in the "Administrator Settings" menu (see [Signal Format - HDMI 1 / HDMI 2 \[▶ 36\]](#)).
- Check whether the setting for the resolution of the PC matches the resolution of the monitor.

6.3 Other Problems

The Setting menu does not appear.

- Check whether the operation switch lock function is active (see [Key Lock \[▶ 37\]](#)).

Cannot select items in the Setting menu.

- Items that are displayed with gray text cannot be changed.
- "Color" items cannot be changed in some color modes. Setting the color mode to "User 1" or "User 2" will allow you to change all items (see [Color \[▶ 20\]](#)).

No audio output.

- Check whether the volume is set to "0".
- Check the PC and audio playback software to see whether they are configured correctly.

- If you are using PbyP/PinP display, check the "Sound Selection (PbyP/PinP)" settings (see [Sound Selection \(PbyP/PinP\) \[▶ 26\]](#)).

USB peripheral devices connected to the monitor do not work / Cannot use the Docking Station Function

- Check whether the USB cable is correctly connected between the PC and the monitor.
- When two PCs are connected to one monitor, check whether the correct USB upstream port is enabled (see [4.4 Linking the Input Signal and USB Port \[▶ 32\]](#)).
- Check whether the peripheral device is correctly connected to the USB downstream port of the monitor.
- Try using a different USB downstream port on the monitor.
- Try using a different USB port on the PC.
- Check whether the device driver of the peripheral device is up-to-date.
- Reboot the PC.
- When "Compatibility Mode" is set to "Off" in the "Administrator Settings" menu and the power of the monitor is turned off, devices connected to the USB downstream port are not operational. Change the setting for "Compatibility Mode" to "On" (see [Compatibility Mode \[▶ 35\]](#)).
- When "USB" is set to "Off" in the "Administrator Settings" menu, peripheral devices connected to the USB port cannot be used. Set "USB" to "On" (see [USB \[▶ 35\]](#)).
- In the following cases, the LAN port cannot be used.
 - When "Ethernet" is set to "Off" in the "Administrator Settings" menu. Set "Ethernet" to "On" (see [Ethernet \[▶ 36\]](#)).
 - When a USB-C connection is not used.
 - When the operating system of the PC is not supported (see [Network \[▶ 50\]](#)).
- If the peripheral devices work correctly when they are directly connected to the PC, contact your local EIZO representative.
- Check the PC's BIOS (UEFI) setting for USB when using Windows. (See the manual of the PC for details.)
- Check if the operating system of the PC is up-to-date.
- If you are using macOS Ventura (13), select "Allow" in the "Allow accessory to connect?" message window that appears when connecting via USB.

Power indicator is flashing orange and white.

- This issue may occur when the PC is connected to the DisplayPort connector. Use a signal cable recommended by us for the connection. Turn the monitor off and on.
- Check the connection and condition of the USB peripheral devices connected to the monitor.
- Check that the power required for the USB peripheral device connected to the monitor does not exceed the power that can be supplied from the USB port of the monitor.
- Turn off the main power switch on the back of the monitor, and then turn it on again.
- If the monitor is connected to a laptop with a USB-C cable, connect an AC adapter to the laptop.

Even when the mouse or keyboard are used, the PC does not return from sleep.

- Turn the setting "On" for "Compatibility Mode" on the "Administrator Settings" menu (see [Compatibility Mode \[▶ 35\]](#)).

The monitor does not supply power (USB Power Delivery) to the PC.

- Check whether the PC has the specifications to operate with a 94 W power supply.
- For a 94 W power supply, use the following USB cables:
 - CC150SS81G-5A or CC150SS81GW-5A (Included)
 - CC100 (Optional accessory)
- Turn the setting "On" for "USB" on the "Administrator Settings" menu (see [USB \[▶ 35\]](#)).

7 Attaching/Removing the Stand

7.1 Removing the Stand

The stand section of this product can be removed.

Attention

- Do not move the stand up and down after removing it. If you move the stand up and down while it is not attached to the monitor, this may cause damage or injury.
- If you drop the monitor or stand, this may cause damage or injury due to the weight of the monitor and stand.

1. Raise the height of the monitor to the maximum height.

Attention

- If the monitor is not raised to the maximum height, there may be cases when the height of the monitor accidentally changes while removing the stand. This may be the cause of injury or damage.

2. **Lay the LCD monitor on a soft cloth spread over a stable and flat surface with the LCD panel surface facing down.**

3. Remove the stand.

As shown in the diagram, press the lock button (1) while holding firmly onto the brace of the stand, and slide the stand in the direction of the pedestal on the bottom (2). Next, pull the stand upwards to remove it (3).

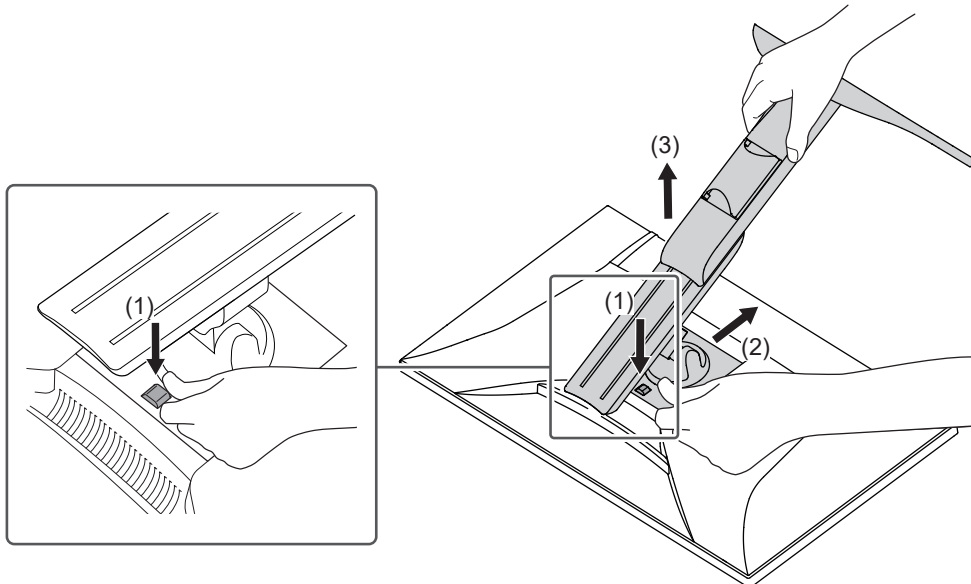

7.2 Attaching the Optional Arm

The optional arm (or optional stand) can be attached by removing the stand section. Please refer to our web site for the supported optional arms (or optional stands).

(www.eizoglobal.com)

When attaching an arm or stand, the installable orientations and movement range (tilt angle) are as follows:

- Orientation

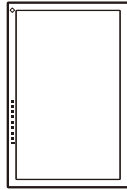

- Movement range (tilt angle): when not using an edge support

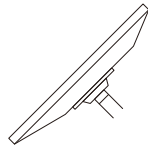

Up: 45°

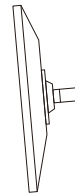

Down: 5°

- Movement range (tilt angle): when using an edge support

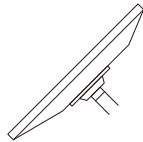

Up: 45°

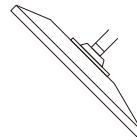

Down: 45° *1

*1 When installing at an angle between 5° and 45° downward, the warranty is only valid if the edge supports have been attached. If the monitor is used in these positions without the edge supports, the front panel may come away. If you require edge supports, contact the EIZO group company or distributor in your country or territory (www.eizoglobal.com/contact/).

Attention

- When attaching an arm or stand, follow the instructions of the respective User's Manual.
- When using another manufacturer's arm or stand, confirm the following in advance and select one conforming to the VESA standard.
 - Clearance between screw holes: 100 mm x 100 mm
 - Arm or stand VESA mount dimensions: 122 mm x 122 mm or less
 - Plate thickness: 2.6 mm
 - Strong enough to support weight of the monitor unit (excluding the stand) and attachments such as cables
- Connect the cables after attaching an arm or stand.
- Do not move the removed stand up and down. Doing so may result in injury or device damage.
- The monitor, arm, and stand are heavy. Dropping them may result in injury or equipment damage.
- Check periodically that the screws are tight enough. If the screws are not tight enough, the monitor may come unattached. This may be the cause of injury or damage.

1. Attach the arm or stand to the monitor.

For installation, use commercially available screws that meet the following conditions:

- Nominal diameter: M4
- Length: Between 8.6 mm and 10.2 mm (if using washers, add the washer thickness)

7.3 Attaching the Original Stand

1. Lay the LCD monitor on a soft cloth spread over a stable and flat surface with the LCD panel surface facing down.
2. Remove the fixing screws on the optional arm (or optional stand), and detach the optional arm (or optional stand).
3. Attach the original stand.
Insert the four tabs on the stand into the four holes on the back panel (1), and slide the stand towards the upper portion of the monitor (2). The stand clicks when it is attached correctly. Check that the stand is properly attached by pushing it side to side and back to front.

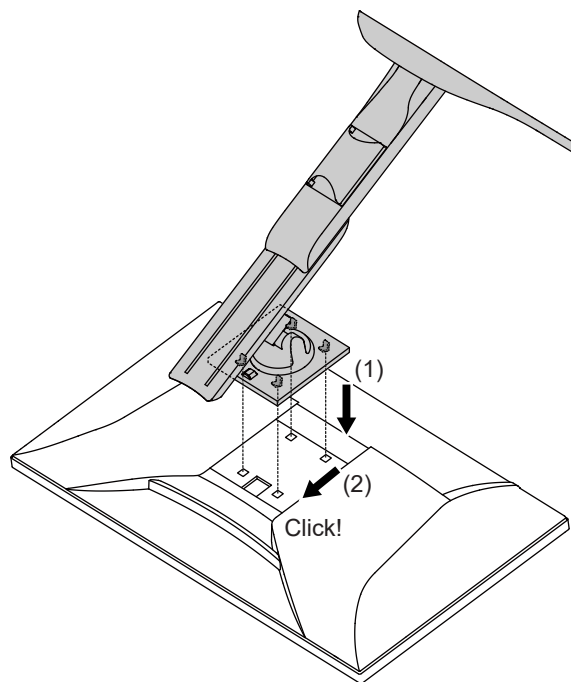

8 Reference

8.1 Using the Docking Station Function

This product is equipped with a LAN port and USB hub so that it can be used as a docking station. By connecting a USB-C cable, you can create a stable network environment even on notebook PCs or tablet devices that are not equipped with LAN ports. In addition, peripheral devices that support USB can be used, and smartphones can be charged.

1. Connect a USB-C cable (CC150SS81G-5A or CC150SS81GW-5A).
2. Connect the LAN cable to the monitor's LAN port.
3. If necessary, connect a mouse, keyboard, or other device to the USB downstream port.

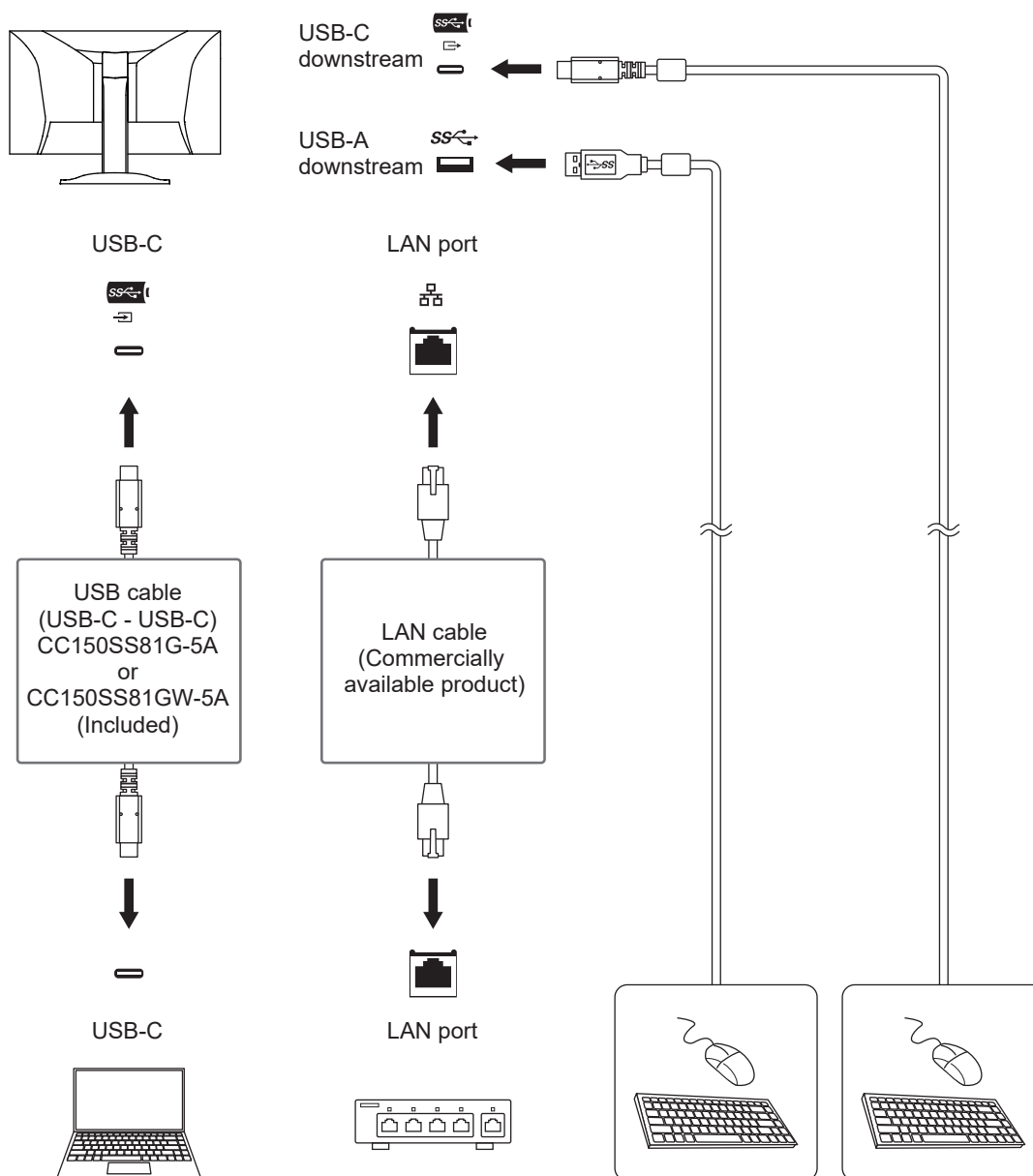

Attention

- This function may not work depending on the PC you are using, your OS, and your peripheral devices. Contact the manufacturer of each device for information about USB compatibility.
- Even when the monitor is in power saving mode, devices connected to the USB downstream port are operational. Due to this, the power consumption of the monitor varies depending on the connected devices, even in power saving mode.
- When the main power switch of the monitor is off, a device connected to the USB downstream port will not operate.
- When [Compatibility Mode \[▶ 35\]](#) is set to "Off" and the monitor power is turned off, devices and LAN ports connected to the USB downstream port are not operational.

Note

- The MAC address can be found on the back of the monitor. MAC address pass-through is not supported.
- This product supports USB 5Gbps. When connecting to peripheral devices that support USB 5Gbps, high-speed data communication is possible.
For USB-C connection, you can switch between display signal priority "HBR2 / USB2.0" and USB speed priority "HBR3 / USB3.2 Gen1" (see [Signal Format - USB-C \[▶ 36\]](#)). The default setting is "HBR3 / USB3.2 Gen1" and the maximum USB transfer speed is 5 Gbps.
- For USB-B connection, the LAN port cannot be used.

8.2 Specifications

8.2.1 LCD Panel

Type	IPS (Anti-Glare)	
Backlight	LED	
Size	31.5" (80 cm)	
Resolution	3840 dots x 2160 lines	
Display Size (H x V)	697.3 mm x 392.2 mm	
Pixel Pitch	0.182 mm x 0.182 mm	
Display Colors	8-bit colors	16.77 million colors
Viewing Angle (H / V, typical)	178° / 178°	
Response Time (typical)	Middle Tone Area	14 ms (overdrive setting: Off) 5 ms (overdrive setting: Enhanced)

8.2.2 Video Signals

Input Terminals	DisplayPort (HDCP 1.3/2.3 compatible) x 1, HDMI (HDCP 1.4/2.3 compatible) ^{*1} x 2, USB-C (DisplayPort Alt Mode, HDCP 1.3/2.3 compatible) x 1	
Digital Scanning Frequency (H / V)	DisplayPort	Horizontal: 31 kHz to 134 kHz / Vertical: 29 Hz to 61 Hz, 69 Hz to 71 Hz (at 720 x 400)
	HDMI	Horizontal: 31 kHz to 135 kHz / Vertical: 29 Hz to 61 Hz, 69 Hz to 71 Hz (at 720 x 400)
	USB-C (DisplayPort Alt Mode)	Horizontal: 31 kHz to 134 kHz / Vertical: 29 Hz to 61 Hz
Frame Synchronization Mode	59.5 Hz – 60.5 Hz	
Max. Dot Clock	DisplayPort	540 MHz
	HDMI	600 MHz
	USB-C (DisplayPort Alt Mode)	540 MHz

*1 HDMI CEC (or mutual control) is not supported.

8.2.3 USB

Port	Upstream	USB-C (USB 5Gbps) ^{*1} x 1, USB-B (USB 5Gbps) x 1
	Downstream	USB-A (USB 5Gbps) x 3, USB-C (USB 5Gbps) x 1
Standard	USB Specification Revision 3.2	
Communication Speed	5 Gbps, 480 Mbps, 12 Mbps, 1.5 Mbps	
Power Supply	Upstream	USB-C (USB 5Gbps): Maximum 94 W (5V/3A, 9V/3A, 15V/3A, 20V/3.5A (with USB-C downstream connection), 20V/4.7V)
	Downstream	USB-A (USB 5Gbps): Maximum 900 mA per port ^{*2} USB-C (USB 5Gbps): Maximum 15 W (5 V/3 A)

*1 Supports Pin Assignment E. The optional accessory CP200 (USB-C - DisplayPort) can be connected to the DisplayPort connector of the PC.

*2 The USB-A connector on the bottom of the monitor can supply power even if the PC and the monitor are not connected via USB.

8.2.4 Audio

Audio Input Format	2ch linear PCM (32 kHz / 44.1 kHz / 48 kHz / 88.2 kHz / 96 kHz / 176.4 kHz / 192 kHz)
Speakers	2 W + 2 W
Headphones	2 mW + 2 mW (32 Ω)
Input Terminals	DisplayPort x 1, HDMI x 2, USB-C (DisplayPort Alt Mode) x 1 (each shared with video signal)
Output Terminals ^{*1}	Headphone jack x 1, Stereo mini jack x 1

*1 When outputting audio from an external speaker connected to the stereo mini jack, do not connect a device to the headphone jack. When outputting audio from the monitor's speakers, do not connect devices to the headphone jack and stereo mini jack.

8.2.5 Network

Port	RJ-45 (USB LAN adapter)
Supported Operating Systems ^{*1}	Windows 11 Windows 10 (32 bit / 64 bit) macOS Sierra (10.12) or later
Wired LAN	IEEE802.3ab (1000BASE-T), IEEE802.3u (100BASE-TX), IEEE802.3 (10BASE-T)

*1 EIZO support will end when OS vendor support ends.

8.2.6 Power

Input	100 – 240 VAC ±10 %, 50 / 60 Hz, 2.00 – 0.85 A
Maximum Power Consumption	196 W or less
Power Save Mode (standard value)	0.35 W (USB device not connected, external load not connected, DisplayPort input only)
Standby Mode (standard value)	0.3 W (external load not connected, only one video signal input)

8.2.7 Physical Specifications

Dimensions	712.2 mm x 438.9 mm – 634.0 mm x 292.3 mm – 318.3 mm (W x H x D) (Tilt: 35°)
	712.2 mm x 427.3 mm – 622.2 mm x 242.4 mm – 250.7 mm (W x H x D) (Tilt: 0°)
Dimensions (Without Stand)	712.2 mm x 415.3 mm x 59 mm (W x H x D)
Net Weight	Approx. 9.4 kg
Net Weight (Without Stand)	Approx. 6.7 kg
Height Adjustment Range	195.0 mm (Tilt: 35°) / 195.0 mm (Tilt: 0°)
Tilt	Up 35°, down 5°
Swivel	90°
Vertical Rotation	Right 90°

8.2.8 Operating Environmental Requirements

Temperature	5 °C – 35 °C
Humidity	20 % – 80 % R.H. (no dew condensation)
Air Pressure	540 hPa – 1060 hPa

8.2.9 Transportation / Storage Environmental Requirements

Temperature	-20 °C – 60 °C
Humidity	10 % – 90 % R.H. (no dew condensation)
Air Pressure	200 hPa – 1060 hPa

8.2.10 Accessories

For the latest information about accessories, refer to our web site.

(www.eizoglobal.com)

Appendix

Trademark

The terms HDMI, HDMI High-Definition Multimedia Interface, HDMI trade dress and the HDMI Logos are trademarks or registered trademarks of HDMI Licensing Administrator, Inc. DisplayPort, the DisplayPort Compliance Logo and VESA are trademarks of the Video Electronics Standards Association in the United States and other countries.

The SuperSpeed USB Trident Logo is a registered trademark of USB Implementers Forum, Inc.



The SuperSpeed USB Power Delivery Trident Logos are trademarks of USB Implementers Forum, Inc.



USB Type-C and USB-C are registered trademarks of USB Implementers Forum, Inc.

DICOM is the registered trademark of the National Electrical Manufacturers Association for its standards publications relating to digital communications of medical information.

Kensington and Microsaver are registered trademarks of ACCO Brands Corporation.

Thunderbolt is a trademark of Intel Corporation in the United States and/or other countries.

Microsoft and Windows are registered trademarks of Microsoft Corporation in the United States and other countries.

Adobe is a registered trademark of Adobe in the United States and other countries.

Apple, macOS, Mac OS, OS X, macOS Sierra, Macintosh and ColorSync are trademarks of Apple Inc.

ENERGY STAR is a registered trademark of the United States Environmental Protection Agency in the United States and other countries.

EIZO, the EIZO Logo, ColorEdge, CuratOR, DuraVision, FlexScan, FORIS, RadiCS, RadiForce, RadiNET, Raptor, and ScreenManager are registered trademarks of EIZO Corporation in Japan and other countries.

ColorEdge Tablet Controller, ColorNavigator, EcoView NET, EIZO EasyPIX, EIZO Monitor Configurator, EIZO ScreenSlicer, G-Ignition, i•Sound, Quick Color Match, RadiLight, Re/Vue, SafeGuard, Screen Administrator, Screen InStyle, ScreenCleaner, SwitchLink, and UniColor Pro are trademarks of EIZO Corporation.

All other company names, product names, and logos are trademarks or registered trademarks of their respective owners.

License

The bitmap font used for this product is designed by Ricoh Industrial Solutions Inc.

