



Owner's Manual



(LED Monitor\*)

---

\* LG LED Monitor applies LCD screen with LED backlights.

Please read this manual carefully before operating your set and retain it for future reference.

27GR83Q

27GR82Q

[www.lg.com](http://www.lg.com)

Copyright © 2023 LG Electronics Inc. All Rights Reserved.

# TABLE OF CONTENTS

## LICENSE.....3

## OPEN SOURCE SOFTWARE NOTICE INFORMATION .....4

## ASSEMBLING AND PREPARING 4

- Supported Drivers and Software .....5
- Product and Button Description.....5
  - How to Use the Joystick Button
- Moving and Lifting the Monitor.....6
  - Installing on a Table
  - Adjusting the Stand Height
  - Adjusting the Angle
  - Pivot Feature
  - Using the Kensington Lock
  - Installing the Wall Mount Plate
  - Installing on the Wall

## USING THE MONITOR..... 15

- Connecting to a PC..... 15
  - HDMI Connection
  - DisplayPort Connection
- Connecting AV Devices..... 16
  - HDMI Connection
- Connecting Peripherals..... 17
  - USB Device connection
  - Connecting Headphones

## USER SETTINGS ..... 18

- Activating the Main Menu ..... 18
  - Main Menu Features
- User Settings ..... 20
  - Menu Settings

## TROUBLESHOOTING..... 32

## PRODUCT SPECIFICATION ..... 36

- Factory Support Mode..... 38
- HDMI Timing (Video)..... 42
- Power LED..... 43

# LICENSE

Each model has different licenses. Visit [www.lg.com](http://www.lg.com) for more information on the license.



The terms HDMI, HDMI High-Definition Multimedia Interface, HDMI trade dress and the HDMI Logos are trademarks or registered trademarks of HDMI Licensing Administrator, Inc.



The SuperSpeed USB Trident logo is a registered trademark of USB Implementers Forum, Inc.



VESA, VESA logo, DisplayPort compliance logo and DisplayPort compliance logo for dual-mode source devices are all registered trademarks of the Video Electronics Standards Association.



For DTS patents, see <http://patents.dts.com>.

Manufactured under license from DTS Licensing Limited. DTS, the Symbol, & DTS and the Symbol together, Headphone:X, and the DTS Headphone:X logo are registered trademarks and/or trademarks of DTS, Inc. in the United States and/or other countries. © DTS, Inc. All Rights Reserved.

## OPEN SOURCE SOFTWARE NOTICE INFORMATION

To obtain the source code that is contained in this product, under GPL, LGPL, MPL, and other open source licenses that have the obligation to disclose source code, and to access all referred license terms, copyright notices and other relevant documents, please visit <https://opensource.lge.com>.

LG Electronics will also provide open source code to you on CD-ROM for a charge covering the cost of performing such distribution (such as the cost of media, shipping, and handling) upon email request to [opensource@lge.com](mailto:opensource@lge.com).

This offer is valid to anyone in receipt of this information for a period of three years after our last shipment of this product.

## ASSEMBLING AND PREPARING

### CAUTION

- Always use genuine LG components to ensure safety and product performance.
- The product warranty will not cover damage or injury caused by the use of unauthorised components.
- It is recommended that use the supplied components.
- If you use generic cables not certified by LG, the screen may not display or there may be image noises.
- Illustrations in this document represent typical procedures, so they may look different from the actual product.
- Do not apply foreign substances (oils, lubricants, etc.) to the screw parts when assembling the product. (Doing so may damage the product.)

- Applying excessive force when tightening screws may cause damage to the monitor. Damage caused in this way will not be covered by the product warranty.
- Do not carry the monitor upside down by just holding the base. This may cause the monitor to fall off the stand and could result in personal injury.
- When lifting or moving the monitor, do not touch the monitor screen. The force applied to the monitor screen may cause damage to it.
- For wave pattern on appearance, unlike the general method of coating, it's applied to added glittering material in raw material. With no peeled-off appearance, it has good durability. Please use it with confidence because there is no problem in using the product at all.

### NOTE

- The components may look different from those illustrated here.
- Without prior notice, all product information and specifications contained in this manual are subject to change to improve the performance of the product.
- To purchase optional accessories, visit an electronics store or an online shopping site, or contact the retailer from where you purchased the product.
- The power cord provided may differ depending upon the region.

## Supported Drivers and Software

You can download and install the latest version from the LGE website ([www.lg.com](http://www.lg.com)).

Drivers and Software	Installation Priority
Monitor Driver	Recommended
OnScreen Control	Recommended
LG Calibration Studio (only 27GR83Q)	Optional



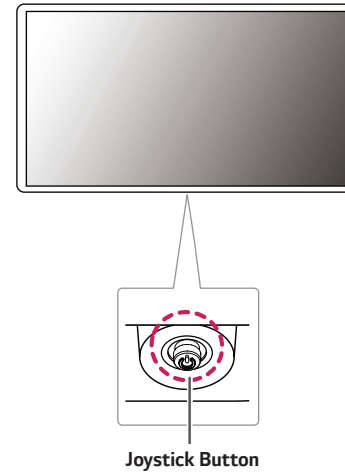



## Product and Button Description



## How to Use the Joystick Button

You can easily control the functions of the monitor by pressing the joystick button or moving it left/right/up/down with your finger.

### Basic Functions

		<b>Power on</b>	Press the joystick button once with your finger to turn on the monitor.
		<b>Power off</b>	Press and hold the joystick button once with your finger to turn off the monitor.
		<b>Volume control</b>	You can control the volume by moving the joystick button left/right.
		<b>Controls screen brightness</b>	You can control the screen's brightness by moving the joystick button up/down.

## Moving and Lifting the Monitor

When moving or lifting the monitor, follow these instructions to prevent the monitor from being scratched or damaged and to ensure safe transportation, regardless of its shape or size.

- Place the monitor in the original box or packing material before attempting to move it.
- Before moving or lifting the monitor, disconnect the power cord and all other cables.
- Hold the bottom and side of the monitor frame firmly. Do not hold the panel itself.
- When holding the monitor, the screen should face away from you to prevent it from being scratched.
- When transporting the monitor, do not expose the monitor to shock or excessive vibration.
- When moving the monitor, keep it upright and never turn the monitor on its side or tilt it sideways.

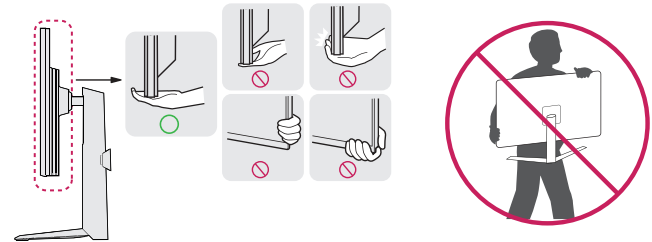



## CAUTION

- Avoid touching the monitor screen as much as possible.
  - This may result in damage to the screen or some of the pixels used to create images.
- If you use the monitor panel without the stand base, its joystick button may cause the monitor to become unstable and fall, resulting in damage to the monitor or human injury. In addition, this may cause the joystick button to malfunction.

## Installing on a Table

- Lift the monitor and place it on the table in an upright position. Place the monitor at least 100 mm away from the wall to ensure sufficient ventilation.

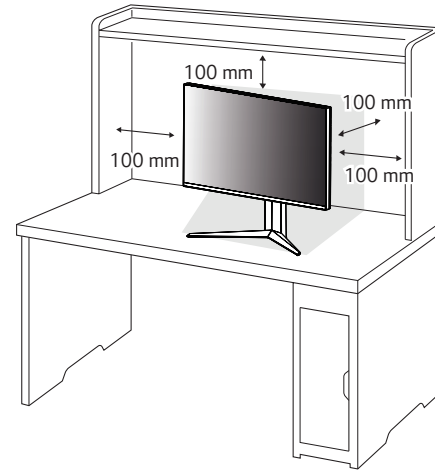

**CAUTION**

- Unplug the power cord before moving or installing the monitor. There is risk of electric shock.
- Make sure to use the power cord that is provided in the product package and connect it to a grounded power outlet.
- If you need another power cord, please contact your local dealer or the nearest retail store.

**Adjusting the Stand Height**

- 1 Place the monitor mounted on the stand base in an upright position.
- 2 Handle the monitor with both hands for safety.

Max. 110.0 mm

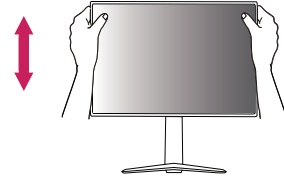
**WARNING**

- When adjusting the screen height, do not place your hand on the stand body to avoid injury to your fingers.



## Adjusting the Angle

- 1 Place the monitor mounted on the stand base in an upright position.
  - 2 Adjust the angle of the screen.
- The angle of the screen can be adjusted forward or backward from  $-5^{\circ}$  to  $15^{\circ}$  for a comfortable viewing experience.

### WARNING

- To avoid injury to the fingers when adjusting the screen, do not hold the lower part of the monitor's frame as illustrated below.

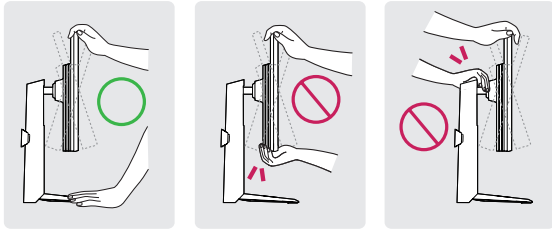

- Be careful not to touch or press the screen area when adjusting the angle of the monitor.

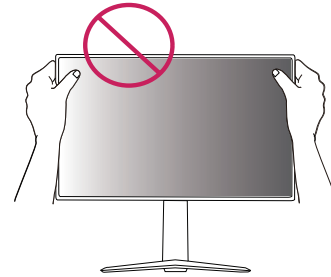

## Pivot Feature

The pivot feature allows the monitor to rotate 90° clockwise.

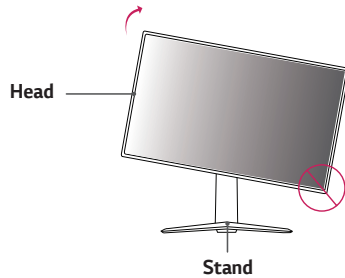

### WARNING

- To avoid scratching the stand base, make sure that when rotating the monitor using the pivot feature, the stand does not make contact with the monitor.
- When using the Pivot function, do not rotate the monitor too fast or with excessive force.
  - The head may come in contact with the stand and scratch the base.
  - Be careful as you may injure your finger by jamming it between the head and the stand.

- 1 Raise the monitor to the maximum height.

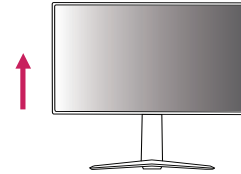

- 2 Adjust the angle of the monitor in the direction of the arrow as shown in the figure.

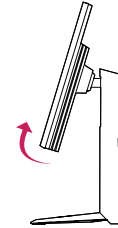

- 3 Rotate the monitor clockwise as shown in the figure.



- 4 Complete the installation by rotating the monitor 90° as shown below.



### WARNING

- Be careful as you may injure your finger by jamming it between the head and the desk.

### NOTE

- Auto Pivot feature of the display is not supported.
- The screen can be rotated easily using the screen pivot shortcut key provided with your Windows operating system. Note that some Windows versions and some graphics card drivers may use different settings for the screen pivot key or may not support the pivot key at all.

## Using the Kensington Lock

The connector for the Kensington security system is located at the bottom of the monitor.

For more information on installation and usage, refer to the Kensington lock owner's manual or visit the website at <http://www.kensington.com>.

Connect the monitor to a table using the Kensington security system cable.

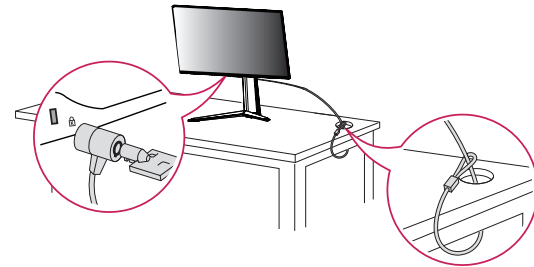

### NOTE

- The Kensington security system is optional. You can obtain optional accessories from most electronics stores.

## Installing the Wall Mount Plate

This monitor meets the specifications for the wall mount plate or other compatible devices.

- 1 Place the screen face down. To protect the monitor panel (screen), cover the surface with a soft cloth or the monitor protection pad included in the product package.
- 2 Remove the four screws tightened on the back of the monitor.
- 3 Place the wall mount plate onto the monitor and align it with the screw holes.
- 4 Tighten the four screws using a screwdriver to fix the plate to the monitor.

### NOTE

- The wall mount plate is sold separately.
- For more information on installation, refer to the wall mount plate's installation guide.
- Be careful not to apply too much force while mounting the wall mount plate as it may cause damage to the screen.

## Installing on the Wall

Install the monitor at least 100 mm away from the wall and leave about 100 mm of space at each side of the monitor to ensure sufficient ventilation. Detailed installation instructions can be obtained from your local retail store. Alternatively, please refer to the manual for how to install and set up a tilting wall mounting bracket.

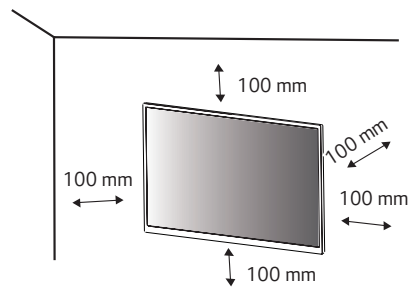

To install the monitor to a wall, attach a wall mounting bracket (optional) to the back of the monitor.

Make sure that the wall mounting bracket is securely fixed to the monitor and to the wall.

- 1 If you use screws longer than the standard length, it may damage the inside of the product.
- 2 A non-VESA standard screw may damage the product and cause the monitor to fall. LG Electronics is not liable for any accidents relating to the use of non-standard screws.

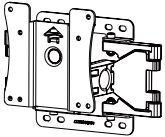
<b>Wall Mount (mm)</b>	100 x 100
<b>Standard screw</b>	M4 x L10
<b>Number of screws</b>	4
<b>Wall Mount Plate (Optional)</b>	LSW 149 

### NOTE

- Use the screws specified by VESA standards.
- The wall mount kit includes the installation guide and all necessary parts.
- The wall mounting bracket is optional. You can obtain optional accessories from your local dealer.
- The length of the screw may differ for each wall mounting bracket. Be sure to use the proper length.
- For more information, please refer to the user manual for the wall mounting bracket.

### CAUTION

- Unplug the power cord before moving or installing the monitor to avoid electric shock.
- Installing the monitor on the ceiling or on a slanted wall may result in the monitor falling off, which could lead to injury. Use an authorised LG wall mount and contact the local dealer or qualified personnel.
- Applying excessive force when tightening screws may cause damage to the monitor. Damage caused in this way will not be covered by the product warranty.

- Use the wall mounting bracket and screws that conform to VESA standards. Damage caused by the use or misuse of inappropriate components will not be covered by the product warranty.
- When measured from the back of the monitor, the length of each installed screw must be 8 mm or less.

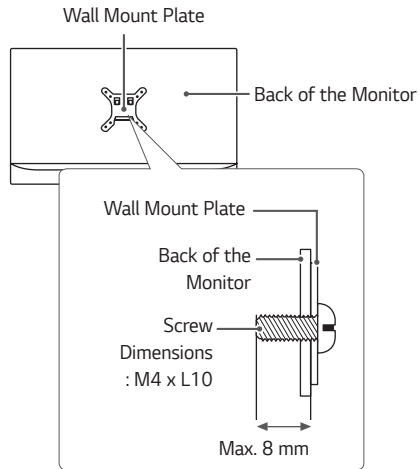

# USING THE MONITOR

- Illustrations in this manual may differ from the actual product. Press the joystick button, go to **Settings** → **Input**, and then select the input option.



## CAUTION

- Do not press the screen for a prolonged time. This may cause image distortion.
- Do not display a still image on the screen for a prolonged time. This may cause image retention. Use a screensaver if possible.



## NOTE

- When connecting the power cord to the outlet, use a grounded (3-hole) power strip or a grounded power outlet.
- The monitor may flicker when turned on in an area where the temperature is low. This is normal.
- Sometimes red, green, or blue spots may appear on the screen. This is normal.

## Connecting to a PC

- This monitor supports the \*Plug and Play feature.
- \* Plug and Play: A feature that allows you to add a device to your computer without having to reconfigure anything or install any manual drivers.

### HDMI Connection

Transmits digital video and audio signals from your PC to the monitor.



## CAUTION

- Using a DVI to HDMI / DP (DisplayPort) to HDMI cable may cause compatibility issues.
- Use a certified cable with the HDMI logo attached. If you do not use a certified HDMI cable, the screen may not display or a connection error may occur.
- Recommended HDMI cable types
  - Ultra High Speed HDMI®/™ cable

## DisplayPort Connection

Transmits digital video and audio signals from your PC to the monitor.

### NOTE

- There may be no video or audio output depending on the DP (DisplayPort) version of the PC.
- If you are using a Mini DisplayPort output graphics card, use a Mini DP to DP (Mini DisplayPort to DisplayPort) cable or gender that supports DisplayPort1.4. (sold separately)

## Connecting AV Devices

### HDMI Connection

HDMI transmits digital video and audio signals from your AV device to the monitor.

### NOTE

- Using a DVI to HDMI / DP (DisplayPort) to HDMI cable may cause compatibility issues.
- Use a certified cable with the HDMI logo attached. If you do not use a certified HDMI cable, the screen may not display or a connection error may occur.
- Recommended HDMI cable types
  - Ultra High Speed HDMI®/™ cable



## Connecting Peripherals

### USB Device connection

The USB port on the product functions as a USB hub.

To use USB 3.0, connect the A-B type USB 3.0 cable of the product to the PC.

Peripheral devices connected to the USB IN port can be controlled from the PC.

#### ! NOTE

- It is recommended you install all Windows Updates to keep your Windows up-to-date before connecting to the product for use.
- Peripheral devices are sold separately.
- A keyboard, mouse, or USB device can be connected to the USB port.
- The charging speed may vary depending on the device.

#### ! CAUTION

Cautions When Using a USB Device

- A USB device with an automatic recognition program installed, or that uses its own driver, may not be recognised.
- Some USB devices may not be supported or may not work properly.
- It is recommended to use a USB hub or hard disk drive with power supplied. (If the power supply is not adequate, the USB device may not be recognised properly.)

## Connecting Headphones

Connect peripherals to the monitor via the headphones port.

#### ! NOTE

- Peripheral devices are sold separately.
- If you use angled earphones, it may cause a problem with connecting another external device to the monitor. Therefore, it is recommended to use straight earphones.



Angled

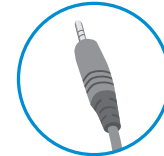

Straight  
(Recommend)

- Depending on the audio settings of the PC and external device, headphones and speaker functions may be limited.

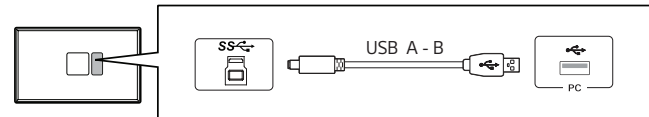

- Please connect the USB A to B cable to use a microphone function with headphones equipped with a microphone.

## USER SETTINGS

### Activating the Main Menu

- 1 Press the joystick button on the bottom of the monitor.
- 2 Move the joystick up/down (▲ / ▼) and left/right (◀ / ▶) to set the options.
- 3 Press the joystick button once more to exit the main menu.

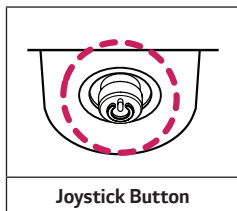

Button	Menu Status	Description
	Main menu disabled	Enables the main menu.
	Main menu enabled	Enters the <b>Settings</b> feature. (Holding down the button to turn off the monitor. You can turn off the monitor this way at any time, including when the OSD is on.)
	◀ Main menu disabled	Adjusts the monitor volume level.
	◀ Main menu enabled	Enters the <b>Input</b> feature.
	▶ Main menu disabled	Adjusts the monitor volume level.
	▶ Main menu enabled	Enters the <b>Game Mode</b> feature.
	▲ Main menu disabled	Adjusts the monitor brightness level.
	▲ Main menu enabled	Turns off the monitor.
	▼ Main menu disabled	Adjusts the monitor brightness level.
	▼ Main menu enabled	Exits the main menu.

## Main Menu Features

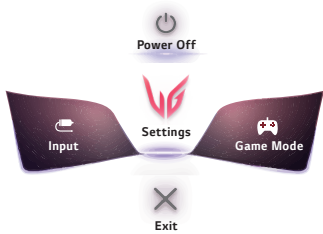

Main Menu	Description
<b>Input</b>	Sets input mode.
<b>Power Off</b>	Turns off the monitor.
<b>Settings</b>	Configures the screen settings.
<b>Game Mode</b>	Sets the game mode for gaming.
<b>Exit</b>	Exits the main menu.

## User Settings

### Menu Settings

- 1 To view the OSD menu, press the joystick button at the bottom of the monitor and then enter the **Settings**.
- 2 Configure the options by moving the joystick up/down/left/right.
- 3 To return to the upper menu or set other menu items, move the joystick to ◀ or pressing (⏻) it.
- 4 If you want to exit the OSD menu, move the joystick to ◀ until you exit.



Game Mode



Game Adjust



Picture Adjust



Input





General

Game Mode on SDR(Non-HDR)signal.

Settings > Game Mode		Description
Game Mode	Gamer 1	In this mode, users can customise elements including game-related options.
	Gamer 2	<b>Gamer 1</b> and <b>Gamer 2</b> picture modes allow you to save two sets of customised display settings, including game-related setup options.
	FPS	This mode is optimised for FPS games. It is suitable for very dark FPS games.
	RTS	This mode is optimised for RTS games.
	Vivid	Optimised the screen for vivid colours.
	Reader	Optimises the screen for viewing documents. You can brighten the screen in the OSD menu.
	HDR Effect	Optimises the screen for high dynamic range.
	sRGB	A standard RGB colour space for the monitor and printer.
	Color Weakness (only 27GR83Q)	This mode is for users who cannot distinguish between red and green. It enables users with color weakness to easily distinguish between the two colors.
	Calibration 1 (only 27GR83Q)	Adjusts to the calibrated screen.
	Calibration 2 (only 27GR83Q)	
	 <b>NOTE</b> (only 27GR83Q) <ul style="list-style-type: none"> <li>• <b>Calibration 1/Calibration 2</b> : Please install LG Calibration Studio to run calibration.</li> </ul>	

## Game Mode on HDR signal.

Settings > Game Mode		Description
Game Mode	Gamer 1	In this mode, users can customise elements including game-related options.
	Gamer 2	<b>Gamer 1</b> and <b>Gamer 2</b> picture modes allow you to save two sets of customised display settings, including game-related setup options.
	FPS	This mode is optimised for FPS games. It is suitable for very dark FPS games.
	RTS	This mode is optimised for RTS games.
	Vivid	Optimised the screen for vivid colours.
	 <b>NOTE</b> <ul style="list-style-type: none"> <li>• HDR content may not be operated properly depending on the Windows10 OS setting. Please check the HDR On / Off setting of Windows.</li> <li>• When the HDR function is turned on, the characters or picture quality may be poor according to Graphic card performance.</li> <li>• While the HDR function is on, screen flickering or cracking may occur when changing the monitor input or power on/off according to Graphic card performance.</li> <li>• For information about whether the graphics card and game support HDR, visit their manufacture's website.</li> </ul>	

Settings > Game Adjust		Description	
Game Adjust	Motion Blur Reduction (only 27GR82Q)	On	This mode minimizes motion blur in fast-moving videos. This function is available for the following vertical frequency. - 120 Hz/ 144 Hz: HDMI - 120 Hz/ 144 Hz/ 165 Hz: DisplayPort
		Off	Turns <b>Motion Blur Reduction</b> Mode off.
		 <b>NOTE</b> <ul style="list-style-type: none"> <li>To reduce motion blur, brightness is reduced with backlight control.</li> <li><b>Motion Blur Reduction</b> and FreeSync feature can not be used at the same time.</li> <li>This function is game-optimized.</li> <li>It is recommended to turn off when you are not using the gaming function.</li> <li>Flicker may occur during <b>Motion Blur Reduction</b> operation.</li> </ul>	
	Overclock (only 27GR82Q)	On	Sets Overclock to a higher refresh rate than specified by the panel specification.
		Off	Disables the Overclock feature.
		 <b>NOTE</b> <ul style="list-style-type: none"> <li>After the monitor reboots, change the maximum refresh rate setting in the GPU control panel.</li> <li>If the screen display appears abnormal, turn off the Overclock setting.</li> <li>The function can only be used through DisplayPort.</li> <li>The Overclock function's features/performance may vary depending on the graphics card or gaming content.</li> <li>We do not guarantee the performance of the function and are not responsible for any side effects that may occur from its activation.</li> </ul>	

Game Adjust	<b>Adaptive-Sync / VRR (27GR83Q)</b> <b>Adaptive-Sync/ FreeSync Premium (27GR82Q)</b>	Provides seamless and natural images by synchronizing the vertical frequency of the input signal with that of the output signal. (27GR83Q) Provides seamless and natural images in a gaming environment. Note that the screen flickering may occur intermittently in a specific gaming environment. (27GR82Q)	
		 <b>CAUTION</b>	
		<ul style="list-style-type: none"> <li>• Supported Interface: DisplayPort (Adaptive-Sync), HDMI (Variable Refresh Rate).</li> <li>• Supported Graphic Card: A graphic card that supports NVIDIA's G-SYNC or AMD's FreeSync is necessary.</li> <li>• Supported Version: Make sure to update the graphic card to the latest driver.</li> <li>• For more information and requirement, refer to NVIDIA website (<a href="http://www.nvidia.com">www.nvidia.com</a>) and AMD website (<a href="http://www.amd.com">www.amd.com</a>).</li> </ul>	
		<b>Extended</b>	Enables wider frequency range of Adaptive-Sync/VRR function than basic mode. The screen may flicker during the game play.
	<b>Basic</b>	Enables basic frequency range of Adaptive-Sync/VRR function.	
	<b>Off</b>	Adaptive-Sync/VRR function off.	
	<b>Black Stabilizer</b>	You can control the black contrast to have better visibility in dark scenes. You can easily distinguish objects on dark game screens.	





Game Adjust	Response Time	Sets a response time for displayed pictures based on the speed of the screen. For a normal environment, it is recommended that you use <b>Fast</b> . For a fast-moving picture, it is recommended that you use <b>Faster</b> . Once <b>Faster Mode</b> is selected, <b>Motion Blur</b> may occur depending on the content.		
		Faster	Sets the response time to faster.	
		Fast	Sets the response time to fast.	
		Normal	Sets the response time to normal.	
		Off	Does not use the response time improvement feature.	
	Crosshair	Crosshair provides a mark on the center of the screen for First Person Shooter (FPS) games. Users can select the Crosshair that fits their gaming environment among four different Crosshairs.		
	FPS Counter	On	The indicator is displayed on the upper left of the screen. It will reflect the actual frame rate that is received at the input. You can also adjust the position of FPS Counter. (upper left / upper right / lower right / lower left)	
		Off	Does not use the FPS Counter feature.	
		 <b>NOTE</b> <ul style="list-style-type: none"> <li>• <b>FPS Counter</b> and <b>Crosshair</b> feature can not be used at the same time.</li> </ul>		
	Game Reset	Returns game to the default settings.		
		No (only 27GR83Q)	Cancel the select.	
Yes (only 27GR83Q)		Returns to the default settings.		

Settings > Picture Adjust		Description	
Picture Adjust	<b>Brightness</b>	Adjusts the brightness of the screen.	
	<b>Contrast</b>	Adjusts the contrast of the screen.	
	<b>Sharpness</b>	Adjusts the sharpness of the screen.	
	<b>Gamma</b>	<b>Mode 1, Mode 2, Mode 3</b>	The higher the gamma value, the darker the image becomes. Likewise, the lower the gamma value, the lighter the image becomes.
		<b>Mode 4</b>	If you do not need to adjust the gamma settings, select Mode 4.
	<b>Color Temp</b>	<b>Custom</b>	The user can adjust it to red, green, or blue by customization.
		<b>Warm</b>	Sets the screen colour to a reddish tone.
		<b>Medium</b>	Sets the screen colour to between a red and blue tone.
		<b>Cool</b>	Sets the screen colour to a bluish tone.
	<b>Manual</b>	The user can fine-tune the colour temperature.	
	<b>R/G/B</b>	You can customise the picture colour using <b>Red, Green, and Blue</b> colours.	
	<b>Six Color</b>		Meets the user requirements for colours by adjusting the hue and saturation of the six colours (Red, Green, Blue, Cyan, Magenta and Yellow) and then saving the settings.
		<b>Hue</b>	Adjusts the tone of the screen colours.
		<b>Saturation</b>	Adjusts the saturation of the screen colours. The lower the value, the less saturated and brighter the colours become. The higher the value, the more saturated and darker the colours become.
	<b>Black Level</b>		Sets the offset level (for HDMI only). <ul style="list-style-type: none"> <li>Offset: as a reference for a video signal, this is the darkest colour the monitor can display.</li> </ul>
<b>High</b>		Keeps the current contrast ratio of the screen.	
<b>Low</b>		Lowers the black levels and raises the white levels from the current contrast ratio of the screen.	

Picture Adjust	Variable Backlight	Provides extended contrast and gradation on a dark screen depending on game or video content.		
		<b>Faster</b>	27GR83Q	Preferably for PC gaming experiences.
		<b>Fast</b>		Preferably for console gaming experiences.
		<b>Normal</b>		Preferably for playing video content and internet or word-processing.
		<b>Off</b>		Disables the Variable Backlight feature.
		<b>Off</b>	27GR82Q	Disables the Variable Backlight feature.
		<b>Normal</b>		Preferably for playing video content and internet or word-processing.
		<b>Fast</b>		Preferably for console gaming experiences.
		<b>Faster</b>		Preferably for PC gaming experiences.
		 <b>NOTE</b> <ul style="list-style-type: none"> <li>• When these feature is enabled, a slight halo effect may be shown on dark backgrounds. This is normal and not a malfunction.</li> <li>• When these feature is enabled, the screen flickering may occur intermittently.</li> <li>• The function can only be used on HDR content.</li> <li>• It is recommended to turn off when you are not using the gaming function.</li> </ul>		
	DFC	<b>On</b>	Adjusts the brightness automatically according to the screen.	
		<b>Off</b>	Disables the <b>DFC</b> feature.	
	Picture Reset	Do you want to reset your picture settings?		
		<b>No</b>	Cancel the select.	
		<b>Yes</b>	Returns to the default settings.	

Settings > Input		Description		
Input	Input List	Selects the input mode.		
	Aspect Ratio	Adjusts the aspect ratio of the screen.		
		Full Wide (27GR83Q) 16:9 (27GR82Q)	Displays the video in widescreen, regardless of the video signal input.	
		4:3 (only 27GR83Q)	Displays the video in 4:3.	
	Auto Input Switch	When automatic input switch is set to <b>On</b> , display will automatically switch to new input when connected.		
		On (only 27GR83Q)	Enables <b>Auto Input Switch</b> .	
		Off (only 27GR83Q)	Disables <b>Auto Input Switch</b> .	

Settings > General		Description	
General	Language	Sets the menu screen to the desired language.	
	User-defined Key 1	You can customise the main menu to access your preferred menu easily.	
	User-defined Key 2	User-defined Key 1 and User-defined Key 2 appear at the left/right of the main menu.	
	DTS Headphone:X (only 27GR83Q)	Enables the realization of three-dimensional sound with headphones or earphone.	
		Game	This mode is optimized for Game.
		Entertainment	This mode is optimized for Entertainment.
		Sports	This mode is optimized for Sports.
	SMART ENERGY SAVING	Off	Disables DTS Headphone:X function.
		Conserve energy by using luminance compensation algorithm. (only 27GR82Q)	
		High	Saves energy using the high-efficiency SMART ENERGY SAVING feature.
		Low	Saves energy using the low-efficiency SMART ENERGY SAVING feature.
		Off	Disables the SMART ENERGY SAVING feature.
	Deep Sleep Mode (only 27GR83Q)	 <b>NOTE</b> (only 27GR82Q) <ul style="list-style-type: none"> <li>The value of energy saving data may differ depending on panel and panel suppliers.</li> <li>If you select the option of <b>SMART ENERGY SAVING</b> is <b>High</b> or <b>Low</b>, monitor luminance become higher or lower depend on source.</li> </ul>	
		When Deep Sleep Mode is enabled, power consumption is minimized while the monitor is in standby mode.	
		On	Enables <b>Deep Sleep Mode</b> .
		Off	Disables <b>Deep Sleep Mode</b> .

General	Power LED	When the Power LED function is turned on, it operates as follows :	
		On	The power LED turns on automatically.
		Off	The power LED turns off.
		Sleep Mode (Standby Mode)	Blinking. (only 27GR82Q)
	Automatic Standby	Feature that automatically turns off the monitor when there is no movement on the screen for a period of time. You can set a timer for the auto-off function. <b>(8H, 6H, 4H and Off)</b> (27GR83Q) If there is no operation on the monitor for a certain period of time, the monitor will automatically switch to standby mode. (27GR82Q)	
	Input Compatibility Version (27GR83Q)	Please set the Input Compatibility Version to match the version of the connected external device.	
		HDMI	2.1(PC)/2.1(AV)/1.4 If you want to use the HDR, select the Input Compatibility Version to 2.1(PC) or 2.1(AV).
		DisplayPort	1.4(DSC)/1.4/1.2 If you want to use the HDR, select the Input Compatibility Version to 1.4(DSC) or 1.4.
		 <b>NOTE</b> <ul style="list-style-type: none"> <li>• If the connected device supports 2.1 in HDMI but the screen or sound does not work properly, set this function to 2.1(AV).</li> </ul>	
	HDMI Compatibility Mode (27GR82Q)	HDMI Compatibility Mode feature can recognize the legacy equipment that does not support HDMI 2.0.	
On		Enables HDMI Compatibility Mode.	
Off		Disables HDMI Compatibility Mode.	
	 <b>NOTE</b> <ul style="list-style-type: none"> <li>• If the connected device does not support <b>HDMI Compatibility Mode</b>, the screen or sound may not work properly.</li> <li>• When HDMI Compatibility Mode is on, 2560 x 1440 @ 100/120/144 Hz resolution is not supported.</li> <li>• Some older graphics cards do not support HDMI 2.0, but you can select HDMI 2.0 resolution in the control panel of window. This may cause the screen to appear abnormally.</li> </ul>		

General	<b>DisplayPort Version (27GR82Q)</b>	Set DisplayPort Version to the same version as the connected external device. To use the HDR function, set to <b>1.4</b> .	
	<b>Buzzer</b>	This feature lets you set the sound generated from Buzzer when your monitor powers on.	
		<b>On</b>	Enables your monitor's <b>Buzzer</b> .
		<b>Off</b>	Disables your monitor's <b>Buzzer</b> .
	<b>OSD Lock</b>	This feature disables the configuration and adjustment of menus.	
		<b>On</b>	Enables <b>OSD Lock</b> .
		<b>Off</b>	Disables <b>OSD Lock</b> .
		 <b>NOTE</b> <ul style="list-style-type: none"> <li>All features are disabled except <b>Brightness, Contrast, Input in Picture Adjust, OSD Lock</b> and <b>Information in General</b>.</li> </ul>	
	<b>Information</b>	The display information will be shown the Total Power On Time, Resolution.	
	<b>Reset to Initial Settings</b>	Do you want to reset your settings?	
		<b>No</b>	Cancel the reset.
		<b>Yes</b>	Returns to the default settings.

## TROUBLESHOOTING

Nothing is displayed on the screen.	
Is the monitor's power cord plugged in?	<ul style="list-style-type: none"> <li>• Check if the power cord is correctly plugged into the power outlet.</li> </ul>
Is the power LED on?	<ul style="list-style-type: none"> <li>• Check the power cable connection and press the power button.</li> </ul>
Is the power on and the power LED displaying white?	<ul style="list-style-type: none"> <li>• Check that the connected input is enabled (<b>Settings &gt; Input</b>).</li> </ul>
Is the power LED blinking?	<ul style="list-style-type: none"> <li>• If the monitor is in sleep mode, move the mouse, or press any key on the keyboard, to switch the display on.</li> <li>• Check if the computer is turned on.</li> </ul>
Is the <b>The screen is not currently set to the recommended resolution. If you have no video or the screen flickers, see the troubleshooting guide in the product owner's manual.</b> message being displayed?	<ul style="list-style-type: none"> <li>• This occurs when signals transferred from the PC (graphics card) are out of the recommended horizontal or vertical frequency range of the monitor. Please see the Product Specification section of this manual to set the appropriate frequency.</li> </ul>
Is the <b>No Signal</b> message being displayed?	<ul style="list-style-type: none"> <li>• This is displayed when the signal cable between the PC and the monitor is missing or disconnected. Check the cable and reconnect it.</li> </ul>
Have you installed the display driver?	<ul style="list-style-type: none"> <li>• Be sure to install the display driver from our web site: <a href="http://www.lg.com">http://www.lg.com</a>.</li> <li>• Make sure to check if the graphics card supports Plug and Play function.</li> </ul>

Some features are disabled.	
Are some functions not available when you press the Menu button?	<ul style="list-style-type: none"> <li>• The OSD is locked. Go to <b>Settings &gt; General</b> and set <b>OSD Lock</b> to <b>Off</b>.</li> </ul>



<b>The screen retains an image.</b>	
Does image sticking occur even when the monitor is turned off?	<ul style="list-style-type: none"> <li>• Displaying a still image for a prolonged time may cause damage to the screen, resulting in the retention of the image.</li> <li>• To extend the lifetime of the monitor, use a screensaver.</li> </ul>

<b>Screen display is unstable and shaky. / Images displayed on the monitor leave shadow trails.</b>	
Did you select the appropriate resolution?	<ul style="list-style-type: none"> <li>• If the selected resolution is HDMI 1080i 60/50 Hz (interlaced), the screen may be flickering. Change the resolution to 1080p or the recommended resolution.</li> </ul>

<b>2560 x 1440 resolution is not available in DisplayPort. (240 Hz) (only 27GR83Q)</b>	
Is it connected to the correct input?	<ul style="list-style-type: none"> <li>• If it is connected with HDMI input, set it to DisplayPort input. Go to <b>Settings &gt; General &gt; Input Compatibility Version</b> and set the option to <b>1.4(DSC)</b>.</li> <li>• Check if the graphics card supports the <b>DSC</b> (Display Stream Compression).</li> <li>• Check if the graphics card driver has been updated to the latest version.</li> </ul>

<b>2560 x 1440 resolution is not available in HDMI. (240Hz) (only 27GR83Q)</b>	
Is it connected to the correct graphics card?	<ul style="list-style-type: none"> <li>• Check if the graphics card supports 2560 x 1440 / 240 Hz in HDMI.</li> <li>• Check if the graphics card driver has been updated to the latest version.</li> </ul>

 **NOTE**

- **Vertical Frequency:** In order to display an image, the screen must be refreshed dozens of times per second, like a fluorescent lamp. The number of times the screen is refreshed per second is called vertical frequency, or refresh rate, and is represented by Hz.
- **Horizontal Frequency:** The time it takes to display one horizontal line is called the horizontal cycle. If 1 is divided by the horizontal interval, the result is the number of horizontal lines displayed per second. This is called horizontal frequency and is represented by kHz.
- Check if the graphics card's resolution or frequency is within the range allowed by the monitor and set it to the recommended (optimal) resolution **Control Panel > Display > Settings** in Windows. (The settings may differ depending on the operating system (OS) you use.)
- Not setting the graphics card to the recommended (optimal) resolution may result in blurred text, a dimmed screen, a truncated display area or misalignment of the display.
- The setting methods may be different depending on the computer or operating system, and some resolutions may not be available depending on the performance of the graphics card. If this is the case, contact the manufacturer of the computer or graphics card for assistance.
- Some graphics cards may not support 2560 x 1440 resolution. If the resolution cannot be displayed, contact the manufacturer of your graphics card.

<b>The display colour is abnormal.</b>	
Does the display appear discolored (16 colours)?	<ul style="list-style-type: none"> <li>• Set the colour to 24 bit (true colour) or higher. In Windows, go to <b>Control Panel &gt; Display &gt; Settings &gt; Color Quality</b>. (The settings may differ depending on the operating system (OS) you use.)</li> </ul>
Does the display colour appear unstable or monochrome?	<ul style="list-style-type: none"> <li>• Check if the signal cable is connected properly. Reconnect the cable or reinsert the PC's graphics card.</li> </ul>
Are there spots on the screen?	<ul style="list-style-type: none"> <li>• When using the monitor, pixilated spots (red, green, blue, white, or black) may appear on the screen. This is normal for an LCD screen. It is not an error, nor is it related to the monitor's performance.</li> </ul>

<b>No sound from the headphone port.</b>	
Are images displayed using DP (DisplayPort) or HDMI input without sound?	<ul style="list-style-type: none"> <li>• Make sure that the headphone port connections are made properly.</li> <li>• Try increasing the volume with the joystick.</li> <li>• Set the audio output of the PC to the monitor you are using. On Microsoft Windows, go to <b>Control Panel &gt; Hardware and Sound &gt; Sound &gt; set the Monitor as default device</b>. (The settings may differ depending on the operating system (OS) you use.)</li> </ul>

## PRODUCT SPECIFICATION

LCD Screen	Color Depth	HDMI	8-bit/10-bit color is supported.
		DP (DisplayPort)	10-bit color is supported.
		27GR83Q	27GR82Q
Resolution	Max Resolution	2560 x 1440 @ 240 Hz (HDMI/DisplayPort)	2560 x 1440 @ 144 Hz (HDMI) 2560 x 1440 @ 180 Hz (DisplayPort)
	Recommended Resolution	2560 x 1440 @ 240 Hz (HDMI/DisplayPort)	2560 x 1440 @ 144 Hz (HDMI) 2560 x 1440 @ 165 Hz (DisplayPort)
Power Sources	Power Rating	19 V $\overline{\text{---}}$ 3.3 A	
	Power Consumption (Typical)	On mode: 50 W (Typical)* (27GR83Q)	On mode: 49 W (Typical)* (27GR82Q)
		Sleep Mode (Standby Mode): $\leq$ 0.5 W ([Deep Sleep Mode]: [On])** Off Mode: $\leq$ 0.3 W	
AC/DC Adapter	DA-65G19, manufactured by Asian Power Devices Inc. Or ADS-65AI-19-3 19065E, manufactured by SHENZHEN HONOR ELECTRONIC Or ADS-65FAI-19 19065EPG-1, manufactured by SHENZHEN HONOR ELECTRONIC Or ADS-65FAI-19 19065EPK-1, manufactured by SHENZHEN HONOR ELECTRONIC Or ADS-65FAI-19 19065EPCU-1, manufactured by SHENZHEN HONOR ELECTRONIC Or MS-V3420R190-065L0-DE, manufactured by MOSO POWER SUPPLY TECHNOLOGY CO LTD Or MS-V3420R190-065L0-KR, manufactured by MOSO POWER SUPPLY TECHNOLOGY CO LTD Or MS-V3420R190-065L0-US, manufactured by MOSO POWER SUPPLY TECHNOLOGY CO LTD Output: 19 V $\overline{\text{---}}$ 3.42 A		

Environmental Conditions	Operating Conditions	Temperature	0 °C to 40 °C
		Humidity	Less than 80 %
	Storing Conditions	Temperature	-20 °C to 60 °C
		Humidity	Less than 85 %
Dimensions	Monitor Size (Width x Height x Depth)		
	With Stand	613.5 x 577.7 x 253.7 (mm)	
	Without Stand	613.5 x 371.6 x 51.3 (mm)	
Weight (Without Packaging)	With Stand	6.2 kg	
	Without Stand	4.3 kg	

Specifications are subject to change without notice.

The ~ symbol means alternating current, and the --- symbol means direct current.

The Power Consumption level can be different by operating condition and monitor setting.

\* The On mode power consumption is measured with LGE test standard. ( Full White pattern , Maximum resolution)

\*\* The monitor goes to the Sleep Mode in a couple of minutes(Max 5 minutes).

## Factory Support Mode

### HDMI (27GR83Q)

Resolution	Horizontal Frequency (kHz)	Vertical Frequency (Hz)	Polarity (H/V)	Remarks
640 x 480	31.469	59.94	-/-	
800 x 600	37.879	60.317	+/+	
1024 x 768	48.363	60.004	-/-	
1280 x 720	45	60	+/+	
1280 x 1024	79.976	75.025	+/+	
1920 x 1080	67.5	60	+/+	
2560 x 1440	88.787	59.951	+/-	Recommend Timing - Input Compatibility Version: 1.4
2560 x 1440	182.996	119.998	+/-	
2560 x 1440	218.29	143.991	+/-	Recommend Timing - Input Compatibility Version: 2.1(AV)
2560 x 1440	388.511	239.97	+/-	Recommend Timing - Input Compatibility Version: 2.1(PC)

**HDMI (27GR82Q)**

<b>Resolution</b>	<b>Horizontal Frequency (kHz)</b>	<b>Vertical Frequency (Hz)</b>	<b>Polarity (H/V)</b>	<b>Remarks</b>
640 x 480	31.469	59.940	-/-	
800 x 600	37.879	60.317	+/+	
1024 x 768	48.363	60.004	-/-	
1920 x 1080	67.500	60.000	+/+	
2560 x 1440	88.787	59.951	+/-	
2560 x 1440	111.857	74.971	+/-	
2560 x 1440	182.996	119.998	+/-	
2560 x 1440	219.210	143.933	+/-	

**DisplayPort (27GR83Q)**

Resolution	Horizontal Frequency (kHz)	Vertical Frequency (Hz)	Polarity (H/V)	Remarks
640 x 480	31.469	59.94	-/-	
800 x 600	37.879	60.317	+/+	
1024 x 768	48.363	60.004	-/-	
1280 x 1024	79.976	75.025	+/+	
1920 x 1080	67.5	60	+/+	
2560 x 1440	88.787	59.951	+/-	
2560 x 1440	182.996	119.998	+/-	
2560 x 1440	222.151	143.973	+/-	Recommend Timing - Input Compatibility Version: 1.2 / 1.4
2560 x 1440	388.511	239.97	+/-	Recommend Timing - Input Compatibility Version: 1.4(DSC)

\* DSC : Display Stream Compression.

\* To display 144 Hz or over, make sure to use the graphics card that supports DSC (Display Stream Compression).



## DisplayPort (27GR82Q)

Resolution	Horizontal Frequency (kHz)	Vertical Frequency (Hz)	Polarity (H/V)	Remarks
640 x 480	31.469	59.940	-/-	
800 x 600	37.879	60.317	+/+	
1024 x 768	48.363	60.004	-/-	
1920 x 1080	67.500	60.000	+/+	
2560 x 1440	88.787	59.951	+/-	
2560 x 1440	150.919	99.946	+/-	
2560 x 1440	182.996	119.998	+/-	
2560 x 1440	222.151	143.973	+/-	
2560 x 1440	257.169	164.958	+/-	
2560 x 1440	282.537	179.960	+/-	

## HDMI Timing (Video)

### 27GR83Q

Factory Support Mode (Preset Mode)	Horizontal Frequency (kHz)	Vertical Frequency (Hz)	Remarks
480P	31.5	60	
720P	45	60	
1080P	67.5	60	
1080P	135	120	
2160P	135	60	
2160P	255	120	

### 27GR82Q

Factory Support Mode (Preset Mode)	Horizontal Frequency (kHz)	Vertical Frequency (Hz)	Remarks
480P	31.5	60	
720P	45.0	60	
1080P	67.5	60	
1080P	135.0	120	
2160P	135.0	60	

## Power LED

Mode	LED Color
On Mode	Red (For a few seconds)
Sleep Mode (Standby Mode)	Off
Off Mode	Off



The model and serial number of the product are located on the back and on one side of the product.

Record them below in case you ever need service.

Model \_\_\_\_\_

Serial No. \_\_\_\_\_